

User's Guide

USG FLEX H Series

Default Login Details

Login IP Address	https://192.168.168.1
User Name	admin
Password	See Zyxel Device label or 1234
WAN	P1 or P2 (see Table 12 on page 48)
LAN	P3 or P4 (see Table 12 on page 48)

Version 1.31 Edition 1, 1/2025

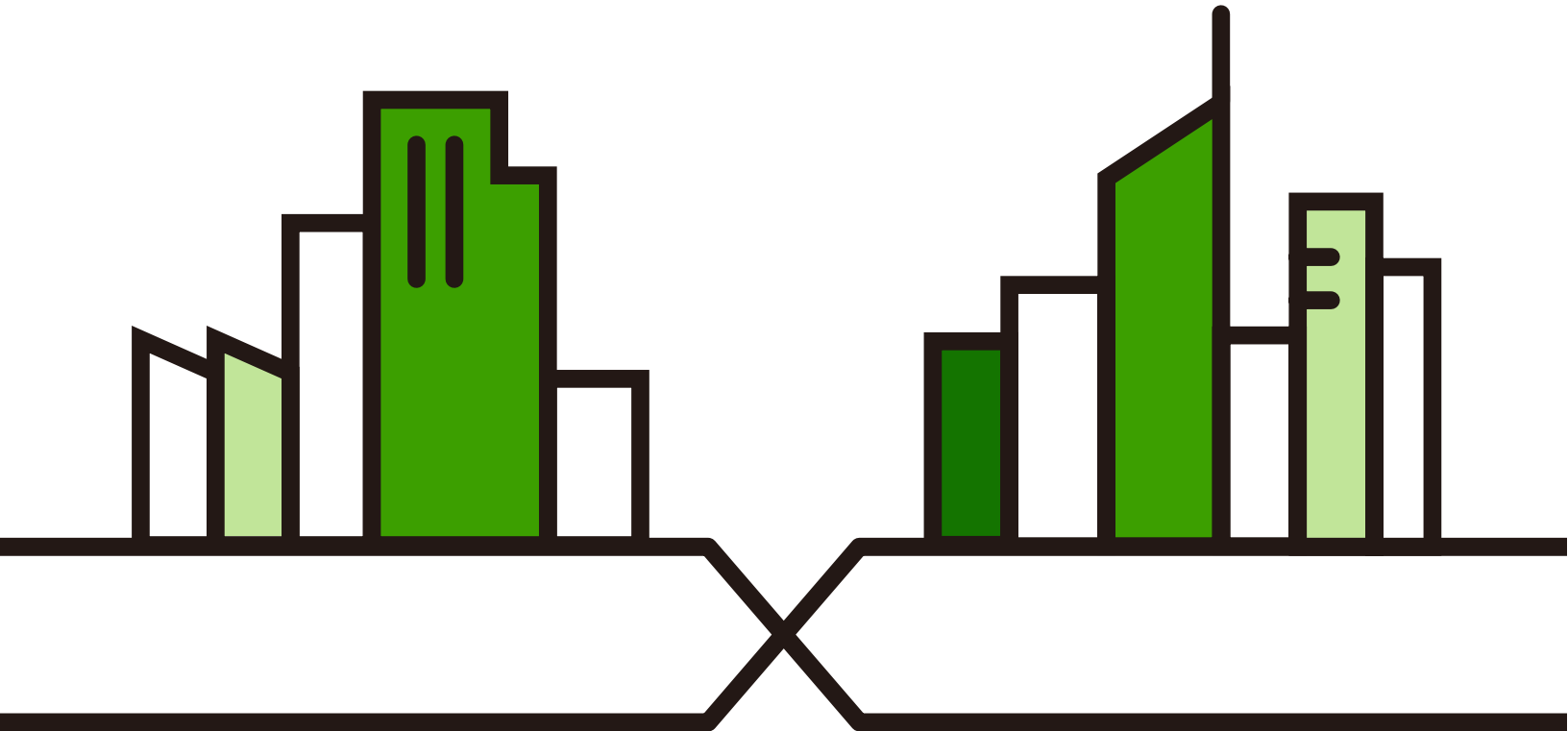

IMPORTANT!

READ CAREFULLY BEFORE USE.

KEEP THIS GUIDE FOR FUTURE REFERENCE.

This is a User's Guide for a series of products and the platform version is listed on the cover. Supported models at the time of writing are listed in [Section 1.1 on page 17](#). Not all products support all firmware features. Not all products support all firmware features. Screenshots and graphics in this book may differ slightly from your product due to differences in product features or web configurator brand style. Every effort has been made to ensure that the information in this manual is accurate.

Note: The version number on the cover page refers to the Zyxel Device's latest firmware version to which this User's Guide applies.

Related Documentation

- Quick Start Guide
The Quick Start Guide shows how to connect the Zyxel Device and access the Web Configurator wizards. (See the wizard real time help for information on configuring each screen.) It also contains a connection diagram and package contents list.
- CLI Reference Guide
The CLI Reference Guide explains how to use the Command-Line Interface (CLI) to configure the Zyxel Device.
- Nebula Control Center (NCC) User's Guide
Go to nebula.zyxel.com to get this User's Guide on how to configure the Zyxel Device using Nebula.

Note: It is recommended you use the Web Configurator to configure the Zyxel Device.

- Web Configurator Online Help
Click the help icon in any screen for help in configuring that screen and supplementary information.
- More Information
Go to support.zyxel.com to find other information on Zyxel Device.



Document Conventions

Warnings and Notes

These are how warnings and notes are shown in this guide.

Warnings tell you about things that could harm you or your device.











Note: Notes tell you other important information (for example, other things you may need to configure or helpful tips) or recommendations.

Syntax Conventions

- All models in this series may be referred to as the "Zyxel Device" in this guide.
- Product labels, screen names, field labels and field choices are all in **bold** font.
- A right angle bracket (>) within a screen name denotes a mouse click. For example, **Network > Interface > Ethernet** means you first click **Network**, then the **Interface** sub menu and finally the **Ethernet** tab to get to that screen.

Icons Used in Figures

Figures in this user guide may use the following generic icons. The Zyxel Device icon is not an exact representation of your device.

Zyxel Device 	Generic Router 	Wireless Router / Access Point 
Switch 	Firewall 	Server 
Internet 	Network Cloud 	Smartphone 
USB Dongle 		

Contents Overview

Introduction	17
Initial Setup Wizard	36
Hardware, Interfaces and Zones	47
Dashboard	63
Monitor	74
Licensing	105
Interfaces	111
Routing	153
NAT	163
BWM (Bandwidth Management)	171
ALG	183
IPSec VPN	187
SSL VPN	228
Security Policy	234
Object	257
Application Patrol	283
Content Filtering	293
Reputation Filter	321
Anti-Malware	341
Sandbox	352
IPS	356
IP Exception	367
SSL Inspection	373
External Block Lists	384
User & Authentication	389
System	415
Log and Report	470
Firmware/File Manager	483
Diagnostics	496
Packet Flow Explore	508
Reboot/ShutDown	519
Troubleshooting	522

Table of Contents

Document Conventions	3
Contents Overview	4
Table of Contents	5
Part I: User's Guide	16
Chapter 1	
Introduction	17
1.1 Overview	17
1.1.1 Fast-path Acceleration	17
1.1.2 Major Model Features	17
1.2 Registration at Nebula Control Center (NCC)	18
1.3 Licenses	18
1.3.1 License Priority	19
1.3.2 Grace Period	19
1.4 Applications	19
1.4.1 Security Router	19
1.4.2 VPN Connectivity	20
1.4.3 User-Aware Access Control	20
1.4.4 Load Balancing	21
1.5 Management Overview	21
1.6 Web Configurator	23
1.6.1 Web Configurator Access	23
1.6.2 Remote Access to the Zyxel Device Networks	24
1.6.3 Web Configurator Screens Overview	25
1.6.4 Navigation Panel	27
1.6.5 Tables and Lists	33
1.6.6 Error /Warning Messages	34
Chapter 2	
Initial Setup Wizard	36
2.1 Initial Setup Wizard Overview	36
2.1.1 Terms of Use/Privacy Policy/Firmware Upgrade Notification	36
2.2 Connect to the Internet	37
2.2.1 Interface Type - DHCP	37
2.2.2 Interface Type - Static	38

2.2.3 Interface Type - PPPoE	39
2.3 System Time	40
2.4 Device Registration	41
2.4.1 Exit the Wizard	42
2.5 License Summary	44
2.6 Subnet Planning	44
2.7 Finish	46
Chapter 3	
Hardware, Interfaces and Zones	47
3.1 Hardware Overview	47
3.1.1 Multi-Gigabit	47
3.1.2 Default Physical Port – Interface Mapping	48
3.1.3 PoE	48
3.1.4 Front Panels	50
3.1.5 Rear Panels	53
3.1.6 Console Port Pin Connectors	55
3.2 Installation Scenarios	56
3.2.1 Desktop Installation Procedure	56
3.2.2 Rack-mounting	57
3.2.3 Wall-mounting	58
3.3 Power Cord Lock	60
3.3.1 Procedure A	60
3.3.2 Procedure B	61
Chapter 4	
Dashboard	63
4.1 Overview	63
4.1.1 What You Can Do in this Chapter	63
4.2 The System Screen	63
4.2.1 System Information Screen	64
4.2.2 Port Status Screen	67
4.2.3 Resource Usage Screen	68
4.2.4 Bandwidth	69
4.2.5 Client Usage Screen	70
4.2.6 The Latest Logs Screen	70
4.3 The Security Screen	71
Part II: Technical Reference	73
Chapter 5	
Monitor	74

5.1 Overview	74
5.1.1 What You Can Do in this Chapter	74
5.2 The Application Usage Screen	75
5.3 The Port Statistics Screen	77
5.4 The Interface Statistics Screen	78
5.5 The Session Monitor Screen	78
5.6 The Content Filter Screen	80
5.7 The Reputation Filter Screens	82
5.7.1 IP Reputation	82
5.7.2 DNS Threat Filter	83
5.7.3 URL Threat Filter	85
5.8 The IPS Screen	86
5.9 The Anti-Malware Screen	87
5.10 The Sandbox Screen	89
5.11 The SSL Inspection Screens	90
5.11.1 The Summary Screen	90
5.11.2 The Certificate Cache List Screen	92
5.12 The Interface Screen	92
5.13 The Device Insight Screen	94
5.14 The Login Users Screen	97
5.15 The Lockout IPs Screen	98
5.16 The DHCP Table Screen	99
5.17 The IPSec VPN Screen	101
5.17.1 The Site to Site VPN Screen	101
5.17.2 The Remote Access VPN Screen	102
5.18 The SSL VPN Screen	103
5.18.1 Regular Expressions in Searching IPSec SAs	103
Chapter 6	
Licensing.....	105
6.1 Licensing Overview	105
6.1.1 What you Need to Know	105
6.1.2 The Licenses Screen	106
6.1.3 The Signature Update Screen	108
6.1.4 Signature Update	109
6.1.5 Auto Update	109
Chapter 7	
Interfaces.....	111
7.1 Interface Overview	111
7.1.1 What You Can Do in this Chapter	111
7.1.2 What You Need to Know	111
7.2 Interface Screen	119

7.2.1 Interface Screen Warning Messages	119
7.2.2 External Interface Add/Edit	122
7.3 Internal Interface	127
7.3.1 Internal Interface Add/Edit	127
7.4 General Interface	133
7.4.1 Add/Edit DHCP Extended Options	138
7.5 VTI Interface	140
7.5.1 Restrictions for IPSec Virtual Tunnel Interface	141
7.5.2 VTI Edit	141
7.6 Trunk Overview	143
7.6.1 What You Need to Know	145
7.7 The Trunk Summary Screen	146
7.7.1 Configuring a User-Defined Trunk	147
7.7.2 Configuring the System Default Trunk	149
7.8 Port	150
Chapter 8	
Routing	153
8.1 Policy and Static Routes Overview	153
8.1.1 What You Can Do in this Chapter	153
8.1.2 What You Need to Know	153
8.2 Policy Route Screen	155
8.2.1 Policy Route Edit Screen	157
8.3 Static Route Screen	160
8.3.1 Static Route Add/Edit Screen	161
Chapter 9	
NAT	163
9.1 NAT Overview	163
9.1.1 What You Can Do in this Chapter	163
9.1.2 What You Need to Know	163
9.2 The NAT Screen	166
9.2.1 The NAT Add/Edit Screen	167
Chapter 10	
BWM (Bandwidth Management)	171
10.1 Overview	171
10.1.1 What You Can Do in this Chapter	171
10.1.2 What You Need to Know	171
10.2 The Bandwidth Management Configuration	173
10.2.1 The Bandwidth Management Add/Edit Screen	175
10.2.2 Adding Objects for the BWM Policy	178
10.3 Example: Prioritize a Specific Application	181

Chapter 11	
ALG	183
11.1 ALG Overview	183
11.1.1 What You Need to Know	183
11.1.2 Before You Begin	184
11.2 The ALG Screen	184
Chapter 12	
IPSec VPN	187
12.1 Virtual Private Networks (VPN) Overview	187
12.2 IPSec VPN Background Information	188
12.2.1 IKE SA Overview	188
12.2.2 Additional Topics for IKE SA	191
12.2.3 Additional Topics for IPSec SA	194
12.2.4 What You Can Do in this Chapter	195
12.2.5 What You Need to Know	195
12.3 The Site to Site VPN Screen	196
12.3.1 The Site to Site VPN Add/Edit Screen- Wizard	197
12.3.2 The Site to Site VPN Add/Edit Screen - Custom	202
12.4 The Remote Access VPN Screen	209
12.5 Remote Access VPN Setup Example	213
12.5.1 Zyxel Device Setup	214
12.5.2 Home User Setup	220
12.5.3 Test the VPN Connection	227
Chapter 13	
SSL VPN	228
13.1 Overview	228
13.1.1 What You Can Do in this Chapter	228
13.1.2 What You Need to Know	228
13.2 The SSL VPN Screen	229
Chapter 14	
Security Policy	234
14.1 Overview	234
14.2 What You Can Do in this Chapter	234
14.2.1 What You Need to Know	235
14.3 The Security Policy Screen	236
14.3.1 Configuring the Security Policy Control Screen	237
14.3.2 The Policy Control Add/Edit Screen	239
14.3.3 Example: Allow a Server to Ping the Zyxel Device Without Creating Logs	241
14.4 DoS Prevention Overview	243
14.4.1 The DoS Prevention Policy Screen	244

14.4.2 The DoS Prevention Profile Screen	245
14.4.3 The Dos Prevention Profile Add/Edit Screen	246
14.5 IP Spoofing Prevention Overview	249
14.5.1 The IP Spoofing Prevention Screen	249
14.5.2 The Trusted IP Add / Edit Screen	251
14.6 The Session Control Screen	251
14.6.1 The Session Control Add/Edit Screen	252
14.7 Security Policy Example Applications	254
Chapter 15	
Object.....	257
15.1 Address/Geo IP Overview	257
15.1.1 What You Need To Know	257
15.1.2 Address Summary Screen	257
15.1.3 Address Group Summary Screen	260
15.1.4 Geo IP Summary Screen	263
15.2 Service Overview	266
15.2.1 What You Need to Know	266
15.2.2 The Service Summary Screen	268
15.2.3 The Service Group Summary Screen	271
15.3 Zone Overview	273
15.3.1 What You Need to Know	274
15.3.2 The Zone Screen	275
15.4 Schedule Overview	277
15.4.1 What You Need to Know	277
15.4.2 The Schedule Screen	277
15.4.3 The Schedule Group Screen	281
Chapter 16	
Application Patrol.....	283
16.1 Overview	283
16.1.1 What You Can Do in this Chapter	283
16.1.2 What You Need to Know	283
16.2 Application Patrol Profile	284
16.2.1 Application Patrol Profile > Add/Edit - Application Management	286
16.3 Example: Block an Application	287
Chapter 17	
Content Filtering.....	293
17.1 Overview	293
17.1.1 What You Can Do in this Chapter	293
17.1.2 What You Need to Know	293
17.2 Content Filtering General Screen	296

17.2.1 Content Filtering Add Profile	298
17.2.2 Content Filtering Profile (Allow List)	311
17.2.3 Content Filtering Profile (Block List)	312
17.2.4 Content Filtering Profile (Blocked URL Keywords)	313
17.2.5 Content Filtering Profile (Test Web Site Category)	314
17.3 Content Filtering Example: Block LAN Users	315
Chapter 18	
Reputation Filter	321
18.1 Overview	321
18.1.1 What You Need to Know	321
18.1.2 What You Can Do in this Chapter	322
18.2 IP Reputation Screen	322
18.2.1 IP Reputation Allow List	325
18.2.2 IP Reputation Block List	326
18.2.3 IP Reputation SecuReporter Allow List	327
18.3 DNS Threat Filter Screen	329
18.3.1 DNS Threat Filter Allow List	331
18.3.2 DNS Threat Filter Block List	332
18.3.3 DNS Threat Filter SecuReporter Allow List	333
18.4 URL Threat Filter Screen	334
18.4.1 URL Threat Filter Allow List	337
18.4.2 URL Threat Filter Block List	338
18.4.3 URL Threat Filter SecuReporter Allow List	339
Chapter 19	
Anti-Malware.....	341
19.1 Overview	341
19.1.1 What You Can Do in this Chapter	344
19.2 Anti-Malware Screen	344
19.3 The Allow List Screen	346
19.4 The Block List Screen	348
19.5 Anti-Malware Technical Reference	350
Chapter 20	
Sandbox.....	352
20.1 Overview	352
20.1.1 What You Need to Know	352
20.2 Sandbox Screen	353
Chapter 21	
IPS.....	356
21.1 Overview	356

21.1.1 What You Can Do in this Chapter	356
21.1.2 What You Need To Know	356
21.1.3 Before You Begin	357
21.2 The IPS Screen	357
21.2.1 Query Example	363
21.3 The Allow List Screen	364
21.4 IPS Technical Reference	365
Chapter 22	
IP Exception.....	367
22.1 Overview	367
22.2 The IP Exception Screen	368
22.2.1 The IP Exception Add/Edit Screen	369
22.3 Example: Bypass a Website	370
Chapter 23	
SSL Inspection.....	373
23.1 Overview	373
23.1.1 What You Can Do in this Chapter	373
23.1.2 What You Need To Know	373
23.1.3 What You Can Do in this Chapter	374
23.1.4 Before You Begin	374
23.2 The SSL Inspection Profile Screen	374
23.2.1 Add/Edit SSL Inspection Profiles	376
23.3 Exclude List Screen	379
23.4 Certificate Update Screen	380
23.5 Install a CA Certificate in a Browser	381
Chapter 24	
External Block Lists	384
24.1 Overview	384
24.1.1 IP Reputation External Block List Screen	384
24.1.2 DNS / URL Threat Filter External Block List Screen	386
Chapter 25	
User & Authentication.....	389
25.1 User/Group Overview	389
25.1.1 What You Need To Know	389
25.1.2 User/Group User Summary Screen	390
25.1.3 User Add/Edit Screen	392
25.1.4 User/Group Group Summary Screen	395
25.1.5 User/Group Setting Screen	397
25.2 User Authentication Overview	401

25.2.1 What You Need To Know	401
25.3 AAA Server Overview	403
25.3.1 AAA Server Configuration	403
25.3.2 Add an AD Server	405
25.3.3 Join an AD Domain	407
25.3.4 Add an LDAP Server	408
25.3.5 Add a RADIUS Server	410
25.4 Two-Factor Authentication Overview	411
25.4.1 User Authentication Two-Factor Authentication	413
Chapter 26	
System.....	415
26.1 Overview	415
26.1.1 What You Can Do in this Chapter	415
26.2 Settings	415
26.2.1 System Settings	415
26.2.2 System Time	416
26.2.3 Administration Settings	416
26.2.4 Settings	418
26.3 Device HA (High Availability)	421
26.3.1 What You Can Do in These Screens	422
26.3.2 Heartbeat	422
26.3.3 Firmware Upgrade on Paired Zyxel Devices	423
26.3.4 Preparing to Deploy Device HA	423
26.3.5 Using NCC To Manage Device HA	424
26.3.6 Deployment Overview	424
26.3.7 HA Status	424
26.3.8 HA Configuration	426
26.3.9 HA Log	427
26.3.10 Disabling Device HA	429
26.4 DNS & DDNS	429
26.4.1 DNS Server Address Assignment	430
26.4.2 The DNS Screen	430
26.4.3 Address/PTR Record	433
26.4.4 Adding an Address/PTR Record	433
26.4.5 CNAME Record	434
26.4.6 Adding a CNAME Record	434
26.4.7 MX Record	435
26.4.8 Adding a MX Record	435
26.4.9 Domain Zone Forwarder	436
26.4.10 Adding a Domain Zone Forwarder	436
26.4.11 Security Option Control	437
26.4.12 Editing a Security Option Control	437

26.4.13 The DDNS Screen	438
26.4.14 The DDNS Add/Edit Screen	439
26.5 SNMP	443
26.5.1 SNMPv3 and Security	444
26.5.2 Supported MIBs	444
26.5.3 SNMP Traps	444
26.5.4 Configuring SNMP	445
26.5.5 Add SNMP V3 User	446
26.6 Notification	447
26.6.1 The Mail Server Screen	448
26.6.2 The Alert Screen	449
26.7 Certificate Overview	453
26.7.1 What You Need to Know	453
26.7.2 Verifying a Certificate	454
26.8 My Certificates	455
26.8.1 The My Certificates Add Screen	457
26.8.2 The My Certificates Edit Screen	460
26.8.3 The My Certificates Import Screen	462
26.9 Trusted Certificates	464
26.9.1 The Trusted Certificates Edit Screen	465
26.9.2 The Trusted Certificates Import Screen	467
26.10 Advanced	468
Chapter 27	
Log and Report.....	470
27.1 Overview	470
27.1.1 What You Can Do In this Chapter	470
27.2 Log/Events Screen	470
27.2.1 Log Details	474
27.3 Log Settings Screen	474
27.4 SecuReporter	477
27.5 Email Daily Report	479
27.5.1 Example Reports	481
Chapter 28	
Firmware/File Manager	483
28.1 Overview	483
28.1.1 What You Can Do in this Chapter	483
28.1.2 What you Need to Know	483
28.1.3 Configuration File Flow at Restart	483
28.2 The Configuration File Screen	484
28.2.1 Example: Back Up and Restore Zyxel Device Configuration	490
28.3 Firmware Management	492

28.3.1 Cloud Helper	493
28.3.2 The Firmware Management Screen	493
Chapter 29	
Diagnostics	496
29.1 Overview	496
29.1.1 What You Can Do in this Chapter	496
29.2 The Diagnostics Screens	496
29.2.1 The Diagnostics Screen	496
29.3 The Packet Capture Screen	498
29.3.1 The Packet Capture Edit Screen	499
29.4 The CPU / Memory Status Screen	502
29.5 The System Log Screen	503
29.6 The Network Tool Screen	505
Chapter 30	
Packet Flow Explore	508
30.1 Overview	508
30.1.1 What You Can Do in this Chapter	508
30.2 Routing Status	508
30.3 The SNAT Status Screen	514
Chapter 31	
Reboot/ShutDown	519
31.1 Overview	519
31.2 The Reboot/Shutdown Screen	519
Part III: Appendices and Troubleshooting	521
Chapter 32	
Troubleshooting	522
32.1 Reserved System Ports	533
32.2 Resetting the Zyxel Device	534
32.3 Restarting the Zyxel Device	535
32.4 Getting More Troubleshooting Help	536
Appendix A Customer Support	537
Appendix B Product Features	542
Appendix C Legal Information	548
Index	557

PART I

User's Guide

CHAPTER 1

Introduction

1.1 Overview

Zyxel Device refers to these models as outlined below.

- USG FLEX 50H
- USG FLEX 100H
- USG FLEX 200H
- USG FLEX 500H
- USG FLEX 50HP
- USG FLEX 100HP
- USG FLEX 200HP
- USG FLEX 700H

1.1.1 Fast-path Acceleration

Fast-path Acceleration is a way to speed up certain traffic such as NAT, IPSec VPN, Security policies through the Zyxel Device by bypassing the kernel. SSL VPN traffic does not use fast-path acceleration.

1.1.2 Major Model Features

The following table lists the key features these models support:

Table 1 Zyxel Device Model Feature Comparison

FEATURE/MODEL	USG FLEX 50H	USG FLEX 50HP	USG FLEX 100H	USG FLEX 100HP	USG FLEX 200H	USG FLEX 200HP	USG FLEX 500H	USG FLEX 700H
DoS Prevention	YES	YES	YES	YES	YES	YES	YES	YES
IPS	YES	YES	YES	YES	YES	YES	YES	YES
Anti-Malware	YES	YES	YES	YES	YES	YES	YES	YES
App Patrol	YES	YES	YES	YES	YES	YES	YES	YES
Content Filtering	YES	YES	YES	YES	YES	YES	YES	YES
SecuReporter	YES	YES	YES	YES	YES	YES	YES	YES
Reputation Filter	YES	YES	YES	YES	YES	YES	YES	YES
Sandboxing	YES	YES	YES	YES	YES	YES	YES	YES
Device Insight	YES	YES	YES	YES	YES	YES	YES	YES
IP Exception	YES	YES	YES	YES	YES	YES	YES	YES
SSL encrypted	YES	YES	YES	YES	YES	YES	YES	YES
Bundled Security Feature License	1 year	1 year	1 year	1 year	1 year	1 year	1 year	1 year
Management by Nebula Cloud Center	YES	YES	YES	YES	YES	YES	YES	YES
Device HA	NO	NO	NO	NO	YES	YES	YES	YES

- See [Table 9 on page 47](#) for a comparison of hardware ports.
- See the Product Features appendix for a more detailed comparison of features.
- See the product's datasheet for detailed information on a specific model.
- For information on interface names by model, default port or interface name mapping, and default interface or zone mapping please see [Section 3.1.2 on page 48](#).

1.2 Registration at Nebula Control Center (NCC)

Nebula Control Center (NCC) is an Internet portal that allows you to configure and monitor groups of Zyxel Devices in organizations. You must register your Zyxel Device at NCC to use security services and upgrade firmware. See **Licensing > Licenses** for security services available for your Zyxel Device.

Use NCC to monitor and manage your Zyxel Device. Use the web configurator to configure the Zyxel Device settings.

Run the initial setup wizard to register your Zyxel Device at NCC. Or you can follow the steps below to register your Zyxel Device at NCC.

- 1 Log into NCC (<https://nebula.zyxel.com>) with your Zyxel Account. If you do not have a Zyxel Account, you should click **Create an account** to create one.
- 2 After you log in, click **Go** under NCC and then **Let's Start** to run the NCC setup wizard. Create an organization and a site or select an existing site.
- 3 Add the Zyxel Device to this site by entering its MAC address and serial number. You'll find the Zyxel Device MAC address and serial number on its label or scan the QR code using the Nebula Mobile app.
- 4 Configure the WAN interface that the Zyxel Device will use to connect to NCC through the Internet.

If you did not register your Zyxel Device at NCC, you will see a reminder to register every time you log into the Zyxel Device web configurator with an admin account.

1.3 Licenses

When you purchase a new Zyxel Device, it comes with the Gold Security Pack license. This license is valid for one year.

The Gold Security Pack license consists of the following services at the time of writing. See **Licensing > Licenses** for the latest services available for your Zyxel Device.

- Anti -Malware
- Application Patrol
- Device Insight
- IPS (Intrusion Prevention System).
- Nebula Professional Pack
- Reputation Filter, including IP Reputation, URL Threat Filter, DNS Threat Filter services and External Blocking Lists (EBL) for these services

- Sandboxing
- Security Profile Sync - Use NCC to apply the same security settings to all Firewalls in the same organization
- SecuReporter
- Web Filtering (Content Filtering)

1.3.1 License Priority

New licenses queue until existing licenses expire. If you buy a new Gold Security Pack, these licenses will be used only after licenses in the existing Gold Security Pack expire.

1.3.2 Grace Period

Service licenses have a 15-day grace period after a license expires. Services will continue to work in this period during which you will receive notifications to renew your licenses. New licenses are valid for 1 year from the date of purchase.

Please note that a trial license does not have a grace period.

1.4 Applications

These are some Zyxel Device application scenarios.

1.4.1 Security Router

Security includes a Stateful Packet Inspection (SPI) firewall.

Figure 1 Applications: Security Router Applications: Security Router

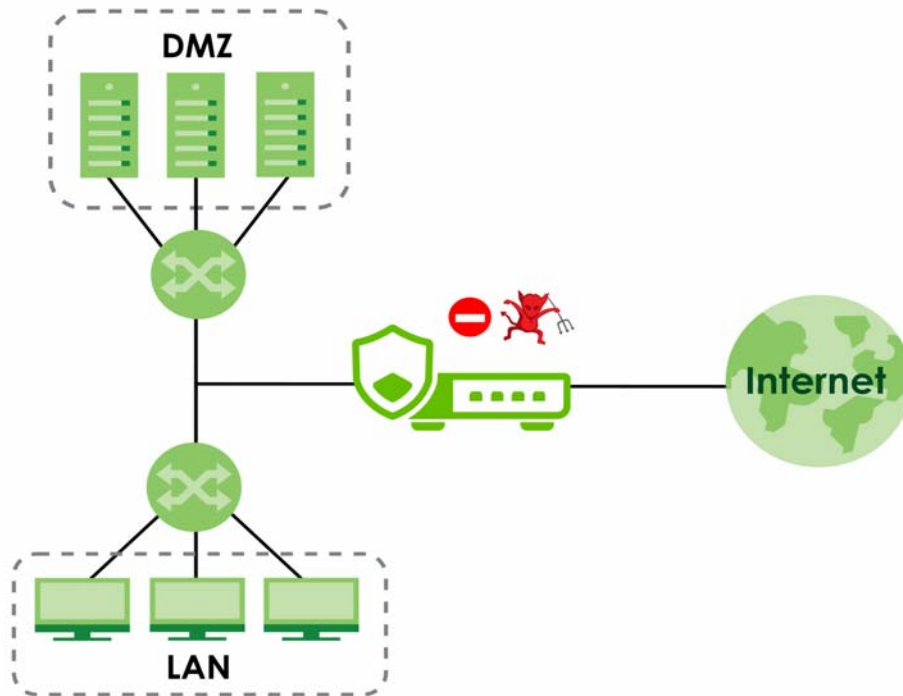

1.4.2 VPN Connectivity

Set up VPN tunnels with other companies, branch offices, telecommuters, and business travelers to provide secure access to your network. AS is an Authentication Server in the below figure.

Figure 2 Applications: VPN Connectivity

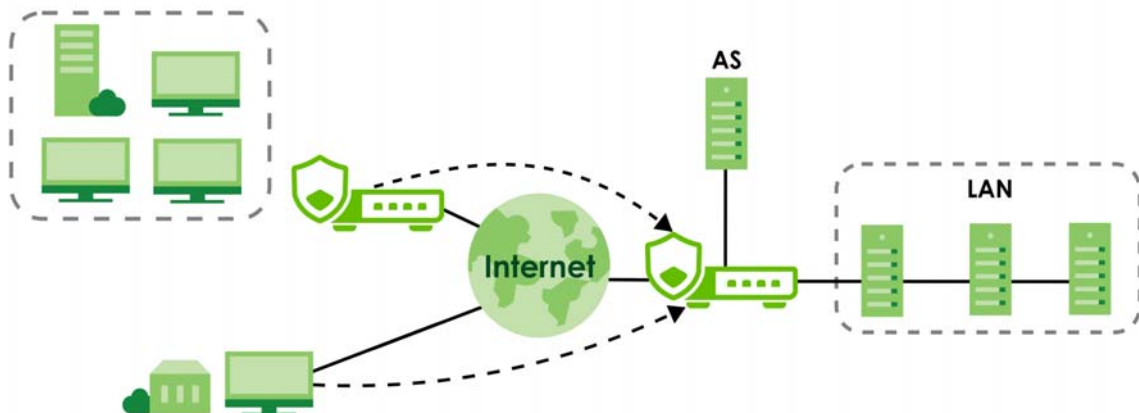

1.4.3 User-Aware Access Control

Set up security policies to restrict access to sensitive information and shared resources based on the user who is trying to access it. In the following figure user **A** can access both the Internet and an internal file server. User **B** has a lower level of access and can only access the Internet. User **C** is not even logged in, so and cannot access either the Internet or the file server.

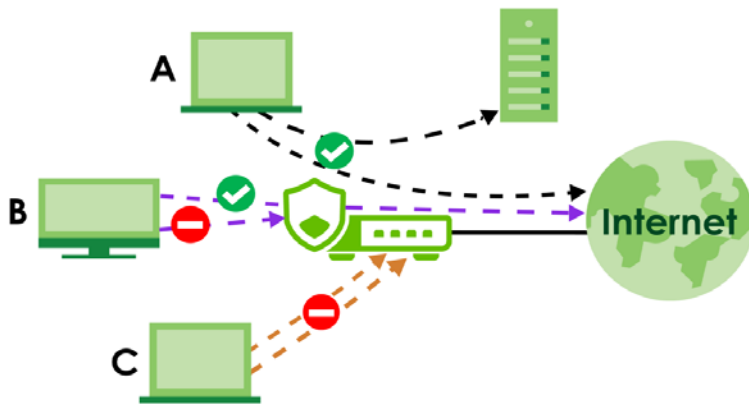
Figure 3 Applications: User-Aware Access Control

1.4.4 Load Balancing

Set up multiple connections to the Internet on the same port, or different ports. In either case, you can balance the traffic loads between them.

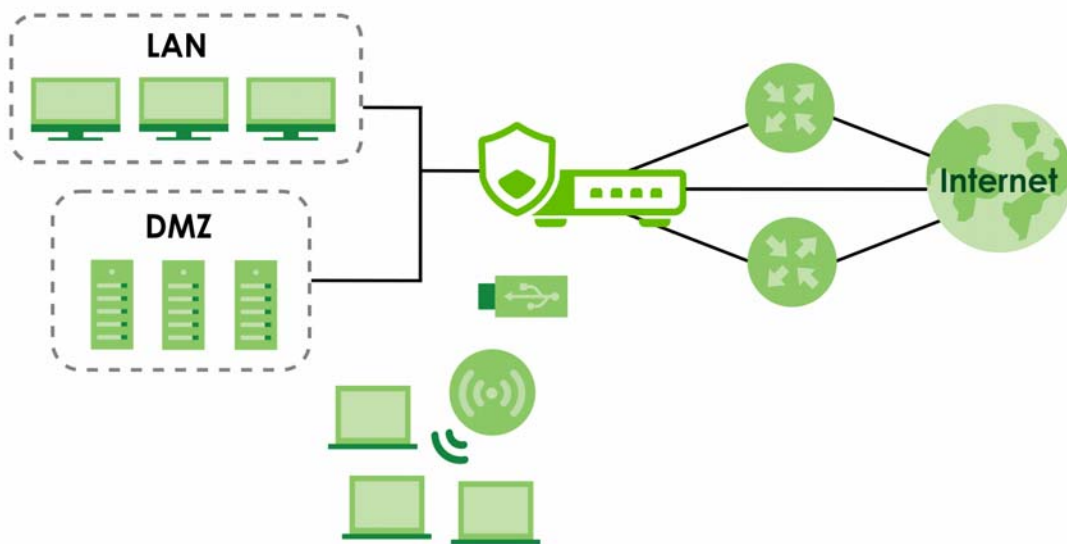
Figure 4 Applications: Multiple WAN Interfaces

1.5 Management Overview

You can manage the Zyxel Device in the following ways.

Web Configurator

The Web Configurator allows easy Zyxel Device setup and management using an Internet browser. This User's Guide provides information about the Web Configurator.

Figure 5 Managing the Zyxel Device: Web Configurator

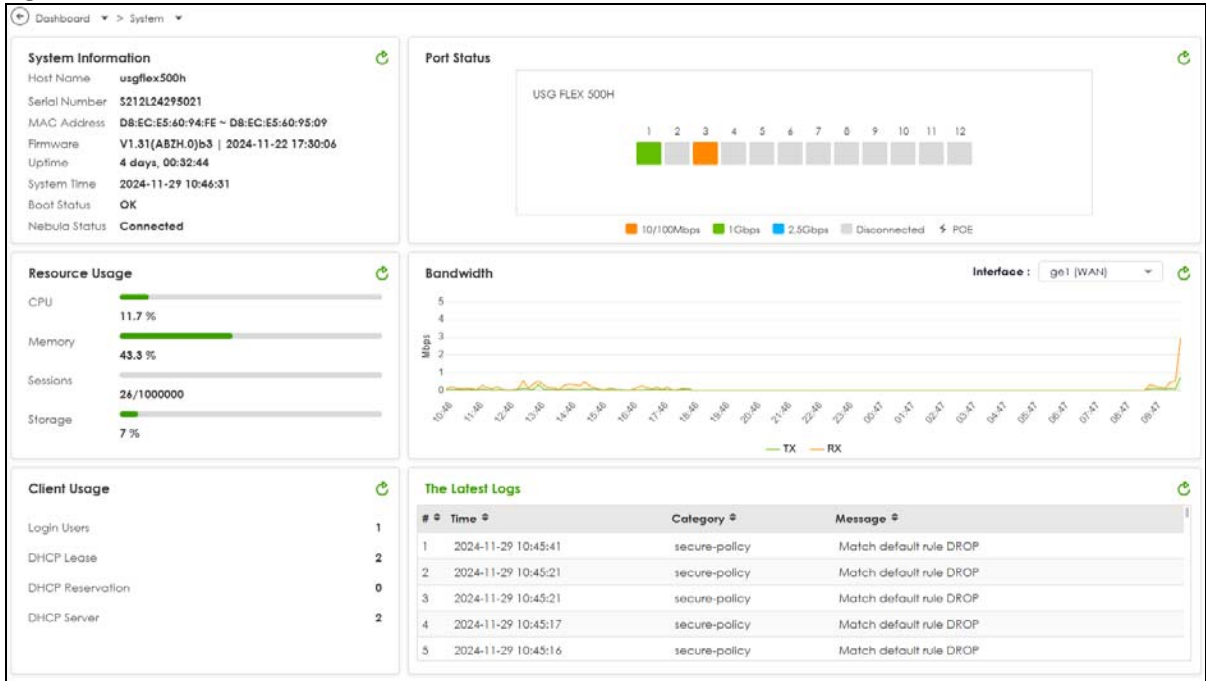

Command-Line Interface (CLI)

The CLI allows you to use text-based commands to configure the Zyxel Device. Access it using remote management (for example, SSH) or via the physical port. See the Command Reference Guide for CLI details. The default settings for the console port are:

Table 2 Console Port Default Settings

SETTING	VALUE
Speed	115200 bps
Data Bits	8
Parity	None
Stop Bit	1
Flow Control	Off

FTP

Use File Transfer Protocol for firmware upgrades and configuration backup or restore.

SNMP

The device can be monitored and/or managed by an SNMP manager. See [Section 26.5 on page 443](#).

Management Authentication

Managers must be authenticated with a username and password, using one of:

- Local Zyxel Device authentication

- An external RADIUS server
- Certificates

1.6 Web Configurator

The Web Configurator is an HTML-based management interface that allows easy system setup and management through Internet browser. Use a browser that supports HTML5, such as Microsoft Edge, Mozilla Firefox, or Google Chrome.

In order to use the Web Configurator you need to allow:

- Web browser pop-up windows from your device.
- JavaScript (enabled by default).

The recommended minimum screen resolution is 1366 x 768 pixels.

Note: Screenshots and graphics in this book may differ slightly from your product due to differences in product features.

1.6.1 Web Configurator Access

- 1 Make sure your Zyxel Device hardware is properly connected. See the Quick Start Guide.
- 2 In your browser go to <https://192.168.168.1>. By default, the Zyxel Device automatically routes this request to its HTTPS server, and it is recommended to keep this setting. The **Login** screen appears.

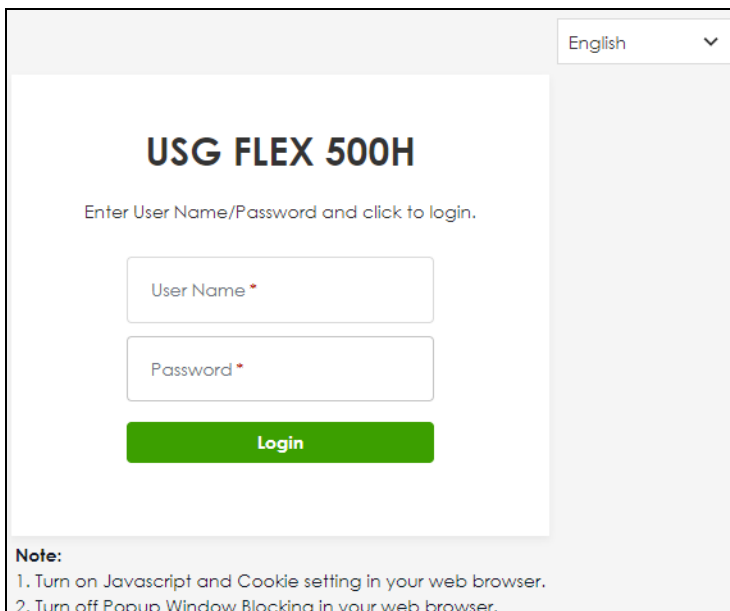

- 3 Select a display language for the Zyxel Device's web configurator screens in the upper right of the screen. The following are the languages supported at the time of writing.



- 4 Type the user name (default: "admin") and password (default: "1234" or see the label on the back of the Zyxel Device).
- 5 Click **Login**. After you log in for the first time using the default user name and password, you must change the default admin password in the **Update Admin Info** screen. Enter a new password of from 1 to 64 characters.

Make a note of your new password, enter it in the following screen, then click **Apply**. The **Login** screen appears again. Log in with your new password.

 A screenshot of the 'Change Password' web interface. At the top, the title 'Change Password' is displayed in a large, bold font. Below the title, a message reads: 'As a security precaution, it is highly recommended that you change the admin default password.' There are two input fields: 'New Password *' and 'Retype to Confirm *'. Below these fields are two buttons: 'Reset' and 'Change'. The 'Change' button is highlighted in green. At the bottom, a 'Note:' section states: 'Your password must be max 63 alphanumeric, printable characters and no spaces.'

1.6.2 Remote Access to the Zyxel Device Networks

Your Zyxel Device keeps your networks safe while allowing external access by applying the security measures below:

- Two-Factor Authentication: Use two-factor authentication to have double-layer security to access a secured network behind the Zyxel Device. The first layer is the VPN client/Zyxel Device's login user name / password. The second layer is an authorized SMS (via mobile phone number) or email address. See [Section 25.4 on page 411](#) for more information on two-factor authentication.

- IPsec VPN: You can create highly secure connections with IKEv2 or EAP authentication to access networks behind the Zyxel Device. For example, home workers can securely access company resources if they have proper authentication. See [Chapter 12 on page 187](#) for more information on IPsec VPN.

1.6.3 Web Configurator Screens Overview

The Web Configurator screen is divided into these parts:

- **A** – title bar
- **B** – navigation panel
- **C** – main window

Figure 6 Web Configurator Screen Overview

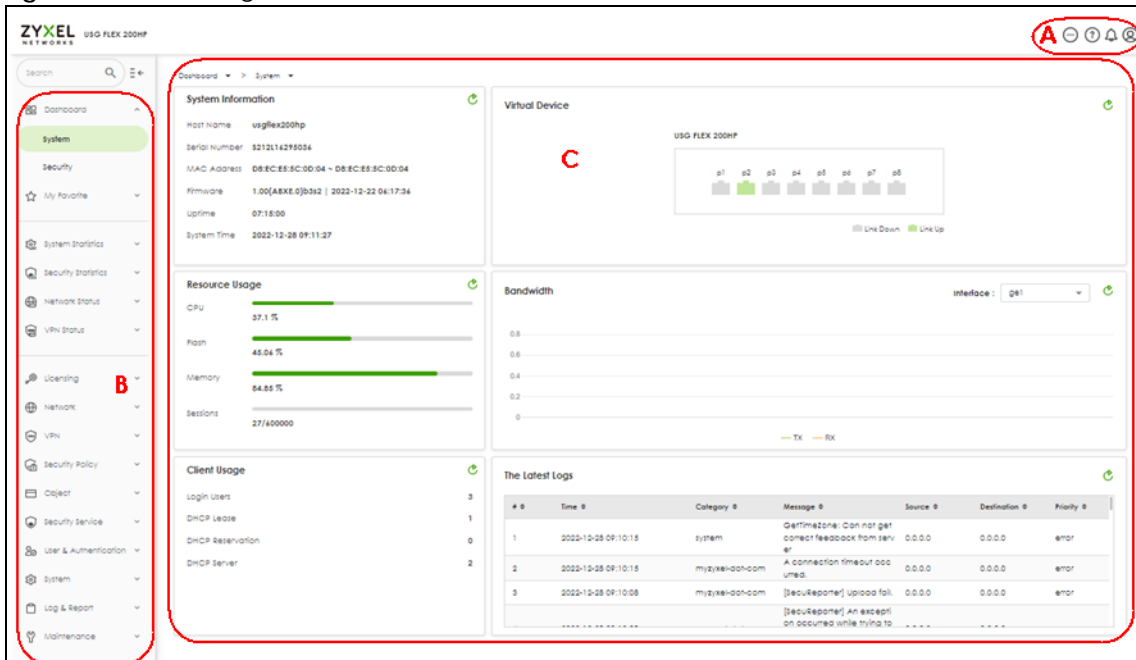

Title Bar

Figure 7 Title Bar





The title bar icons in the upper right corner provide the following functions.

Table 3 Title Bar: Web Configurator Icons

LABEL	DESCRIPTION
Language	Select a display language for the Zyxel Device's web configurator screens.
Web Console	Select this to display a Command Line Interface (CLI) in your browser. See the Command Line Interface Reference Guide for information on commands.

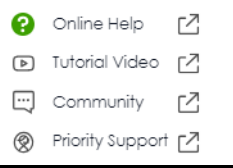
Table 3 Title Bar: Web Configurator Icons (continued)

LABEL	DESCRIPTION
More	 <p>About: Click this to display basic information about the Zyxel Device.</p> <p>Nebula: Click this to go to https://nebula.zyxel.com/ to monitor or manage your Zyxel Device using Nebula.</p> <p>SecuReporter: Click this to go to https://secureporter.cloudcnm.zyxel.com/ for security analytics.</p>
Help	 <p>Online Help: Click this to open the help page for the current screen.</p> <p>Tutorial Video: Click this to go to YouTube to see related Zyxel Device configuration videos.</p> <p>Community: Click this to go to https://community.zyxel.com/en/categories/security for security product line discussions.</p> <p>Priority Support: The Nebula Pro license includes this to get direct assistance from the Nebula technical support team within 24 hours, and access to web chat during Taiwan office hours.</p>
Notification	<p>What's New: Click this to open a PDF file to display what's new in the Zyxel Device firmware.</p> <p>New Features: Click this to display new features with new GUI screens. Click the link to be directed to the new GUI screens.</p>
User	 <p>Change Password: This is for an admin account type only. Click this to change the account password. You will need to log in again using the new password.</p> <p>Logout: Click this log out of the Web Configurator.</p>

About

Click **About** to display basic information about the Zyxel Device.

Figure 8 About



This table describes the fields in this screen.

Table 4 About

LABEL	DESCRIPTION
Current Version	This shows the firmware version of the Zyxel Device.
Release Date	This shows the date (yyyy-mm-dd) and time (hh:mm:ss) when the firmware is released.
System Protection Signature	<p>This shows the system protection signature version of the Zyxel Device. These signatures do not require a license. The Zyxel Device will synch with the Cloud Helper Server every day to update these signatures automatically.</p> <p>System protection signatures protect your Zyxel Device and local networks from web attacks, such as command injection, cross-site scripting and path traversal.</p> <p>Command injection: This is an attack in which an attacker uses the Zyxel Device vulnerabilities to execute commands to control your Zyxel Device.</p> <p>Cross-site scripting: This is an attack in which an attacker implants malicious scripts in a website. When you visit this website, the malicious scripts are sent and executed on your web browser.</p> <p>Path traversal: This is an attack that allows an attacker to access files you store in the web root folder.</p>

1.6.4 Navigation Panel

Use the navigation panel menu items to open status and configuration screens. Click the arrow of the navigation panel to hide the panel. Type an entry in the Search box to find a menu item containing that entry. The following sections introduce the Zyxel Device's navigation panel menus and their screens.

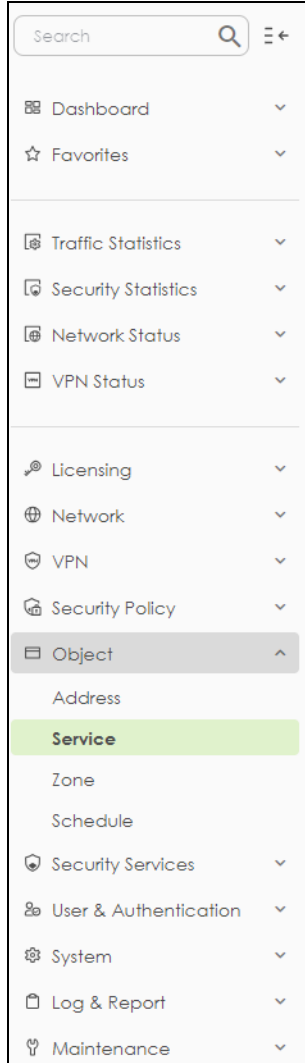
Figure 9 Navigation Panel

Dashboard Screens

The dashboard displays general device information, system status, system resource usage, licensed service status, and interface status in widgets that you can re-arrange to suit your needs. See the Web Help for details on the dashboard.

Table 5 Dashboard Menu Screens Summary

FOLDER OR LINK	TAB	FUNCTION
System		Collect and display the Zyxel Device system information, such as serial number, MAC address and CPU usage.
Security		Collect and display security event statistics.

Monitoring Screens

The monitoring screens display status and statistics information.

Table 6 Monitoring Menu Screens Summary

FOLDER OR LINK	TAB	FUNCTION
Traffic Statistics		
Application Usage	Application Usage	Collect and display application statistics.
Port	Port	Collect and display port statistics.
Interface	Interface	Collect and display interface statistics.
Session Monitor	Session Monitor	Collect and display session statistics.
Security Statistics		
Content Filter	Content Filter	Collect and display content filter statistics
Reputation Filter	IP Reputation	Collect and display IP reputation statistics.
	DNS Threat Filter	Collect and display DNS threat filter statistics.
	URL Threat Filter	Collect and display URL threat filter statistics.
IPS	IPS	Collect and display statistics on the intrusions that the Zyxel Device has detected.
Anti-Malware	Anti-Malware	Collect and display anti-malware statistics.
Sandbox	Sandbox	Displays the sandbox statistics.
SSL Inspection	Summary	Collect and display SSL Inspection statistics.
	Certificate Cache List	Display traffic to destination servers using certificates.
Network Status		
Interface	Interface	Display the status of Zyxel Device interfaces.
Device Insight	Device Insight	Displays a list of WiFi and wired clients connected to the Zyxel Device local networks.
Login Users	Login User	List the users currently logged into the Zyxel Device.
DHCP Table	DHCP Table	Display a list of interfaces and their DHCP-assigned IP addresses.
VPN Status		
IPSec VPN	Site to Site VPN	Display and manage the Zyxel Device IPSec VPN connections with remote IPSec VPN routers that have static IP addresses or a domain names.
	Remote Access VPN	Display and manage IPSec VPN connections from external users who want to access the networks behind the Zyxel Device.
SSL VPN	Remote Access VPN	Display and manage SSL VPN connections from external users who want to access the networks behind the Zyxel Device.

Configuration Screens

Use the configuration screens to configure the Zyxel Device's features.

Table 7 Configuration Menu Screens Summary

FOLDER OR LINK	TAB	FUNCTION
Services		
Licensing	Licenses	Displays if the Zyxel Device is registered and licenses purchased.
	Signature Update	Use this screen to update signatures immediately or by a schedule.
Network		
Interface	Interface	Use this screen to: <ul style="list-style-type: none"> • Create and manage Ethernet interfaces. • Create and manage VLAN interfaces. • Create and manage bridge interfaces. • Configure IP address assignment and interface parameters for VTI (Virtual Tunnel Interface).
	Trunk	Create and manage trunks (groups of interfaces) for load balancing.
	Port	Use this screen to configure the Zyxel Device port settings.
Routing	Policy Route	Create and manage routing policies.
	Static Route	Create and manage IP static routing information.
NAT	NAT	Set up and manage port forwarding rules.
BWM	BWM	Control bandwidth for services passing through the Zyxel Device, and identify the conditions for bandwidth control.
ALG	ALG	Configure FTP pass-through settings.
VPN		
IPSec VPN	Site to Site VPN	Configure Zyxel Device IPSec VPN connections with remote IPSec VPN routers that have static IP addresses or a domain names.
	Remote Access VPN	Configure IPSec VPN connections for external users who want to access the networks behind the Zyxel Device.
SSL VPN	General	Configure SSL VPN connections for external users who want to access the networks behind the Zyxel Device.
Security Policy		
Policy Control	Policy Control	Create and manage level-3 traffic rules and apply Security Service profiles.
DoS Prevention	DoS Prevention Policy	Display and manage ADP bindings.
	Profile	Create and manage DoS prevention profiles.
IP Spoofing Prevention	IP Spoofing Prevention	Bind IP addresses to MAC addresses.
Session Control	Session Control	Limit the number of concurrent client NAT/security policy sessions.
Object		
Address	Address	Create and manage host, range, and network (subnet) addresses.
	Address Group	Create and manage groups of addresses to apply to policies as a single objects.
	Geo IP	Update the database of country-to-IP address mappings and manually configure country-to-IP address mappings for geographic address objects that can be used in security policies.

Table 7 Configuration Menu Screens Summary (continued)

FOLDER OR LINK	TAB	FUNCTION
Service	Service	Create and manage TCP and UDP services.
	Service Group	Create and manage groups of services to apply to policies as a single object.
Zone	Zone	Configure zone templates used to define various policies.
Schedule	Schedule	Create one-time and recurring schedules.
	Schedule Group	Create and manage groups of schedules to apply to policies as a single object.
Security Service		
App Patrol	App Patrol	Manage different types of traffic in this screen. Create App Patrol template(s) of settings to apply to a traffic flow using a security policy.
Content Filtering	Content Filtering	Use this screen to: <ul style="list-style-type: none"> • Create and manage the detailed filtering rules for HTTP(S) traffic scan and DNS domain scan. • Create a list of allowed web sites that bypass HTTP(S) traffic scan and DNS domain scan. • Create a list of web sites to block regardless of content filtering policies.
Reputation Filter	IP Reputation	Enable IP reputation and specify what action the Zyxel Device takes when any IP address with bad reputation is detected. You can also set up an allow list to identify which IPv4 addresses should be allowed, and a block list to identify which IPv4 addresses should be blocked.
	DNS Threat Filter	Enable DNS threat filtering and specify what action the Zyxel Device takes when a access attempt to a blocked Fully Qualified Domain Name (FQDN) is detected. You can also set up an allow list to identify which FQDNs should be allowed, and a block list to identify which FQDNs should be blocked.
	URL Threat Filter	Enable URL filtering and specify what action the Zyxel Device takes when a access attempt to a blocked website is detected. You can also set up an allow list to identify which IPv4 addresses and/or URLs should be allowed, and a block list to identify which IPv4 addresses and/or URLs should be blocked.
Anti-Malware	Anti-Malware	Enable, specify actions to take when encountering malware or compressed files, and set up a block list to identify files with malware file patterns and an allow list to identify files that should not be checked for malware.
Sandbox	Sandbox	Enable sandbox, and specify the actions the Zyxel Device takes when files with unknown or untrusted programs are detected.
IPS	IPS	Enable and configure IPS settings. Create, import, or export custom signatures.
	Allow List	Configure signatures that will be exempted from IPS inspection.
IP Exception	IP Exception	Use this screen to view the IP exception list for the anti-malware, reputation filter and IPS (Intrusion Prevention System) features. The Zyxel Device will not intercept nor inspect the incoming packets that match the rules in the IP exception list for the anti-malware and/or IPS (Intrusion Prevention System) features.

Table 7 Configuration Menu Screens Summary (continued)

FOLDER OR LINK	TAB	FUNCTION
SSL Inspection	Profile	Decrypt HTTPS traffic for Security Service inspection. Create SSL Inspection templates of settings to apply to a traffic flow using a security policy.
	Exclude List	Configure services to be excluded from SSL Inspection.
	Certificate Update	Use this screen to update the latest certificates of servers using SSL connections to the Zyxel Device network.
External Block List	IP Reputation	Set up an external block list which uses block list entries of IP addresses with bad reputations stored in a file on a web server that supports HTTP or HTTPS and is reachable from the Zyxel Device. The Zyxel Device will block incoming and outgoing packets from the black list entries in this file.
	DNS Threat Filter/URL Threat Filter	Set up an external block list which uses block list entries of blocked Fully Qualified Domain Names (FQDN) or blocked URLs stored in a file on a web server that supports HTTP or HTTPS and is reachable from the Zyxel Device. The Zyxel Device will block incoming and outgoing packets from the black list entries in this file.
User & Authentication		
User/Group	User	Create and manage users.
	Group	Create and manage groups of users.
	Setting	Manage default settings for all users, general settings for user sessions, and rules to force user authentication.
User Authentication	AAA	Configure the default authentication server (Local/LDAP/AD/RADIUS) to use for user authentication.
	Two-factor Authentication	Configure Google Authenticator to access a secured network behind the Zyxel Device via the web configurator or SSH connection.
System		
Settings	Settings	Use this screen to configure: <ul style="list-style-type: none"> The Zyxel Device host name. System time settings. Remote access to the Zyxel Device settings. The web configurator language display settings.
Device HA	HA Status	See the license status for Device HA, and see the status of the active and passive devices.
	HA Configuration	Configure Device HA global settings, monitored interfaces and synchronization settings.
	HA Log	See logs of the active and passive devices.
DNS & DDNS	DNS	Configure the DNS server and address records for the Zyxel Device.
	DDNS	Define and manage the Zyxel Device's DDNS domain names.
SNMP	SNMP	Configure SNMP communities and services.
Notification	Mail Server	Configure a mail server with authentication to send reports and password expiration notification emails.
	Alert	Enable to have the Zyxel Device send events notification mails and alert logs.
Certificate	My Certificates	Create and manage the Zyxel Device's certificates.
	Trusted Certificates	Import and manage certificates from trusted sources.
Advanced	System Parameters	Edit default Zyxel Device parameters such as UDP/ICMP timeout, ARP spoofing, device insight and LLDP.
Log & Report		

Table 7 Configuration Menu Screens Summary (continued)

FOLDER OR LINK	TAB	FUNCTION
Log / Events	Log / Events	Use this screen to view the Zyxel Device logs.
Log Setting	Log Settings	Configure the system log, email logs, and remote syslog servers.
SecuReporter	SecuReporter	Enable SecuReporter logging and access the SecuReporter security analytics portal that collects and analyzes logs from your Zyxel Device in order to identify anomalies, alert on potential internal or external threats, and report on network usage.
Email Daily Report	Email Daily Report	Select statistics to email in a daily report.

Maintenance Screens

Use the maintenance screens to manage configuration and firmware files, run diagnostics, and reboot or shut down the Zyxel Device.

Table 8 Maintenance Menu Screens Summary

FOLDER OR LINK	TAB	FUNCTION
Maintenance		
Firmware/File Manager	Configuration File	Manage and upload configuration files for the Zyxel Device.
	Firmware Management	View the current firmware version and upload firmware.
Diagnostics	Diagnostics	Collect diagnostic information.
	Packet Capture	Capture packets for analysis.
	CPU/Memory Status	View CPU and memory usage statistics.
	System Log	View the files of diagnostic information the Zyxel Device has collected and stored on a connected USB storage device.
	Network Tool	Identify problems with the connections. You can use Ping or Traceroute to help you identify problems.
Packet Flow Explore	Routing Status	Check how the Zyxel Device determines where to route a packet.
	SNAT Status	See how the Zyxel Device converts a packet's source IP address and check the related settings.
Reboot/Shutdown	Reboot/Shutdown	Restart or turn off the Zyxel Device.

1.6.5 Tables and Lists

Web Configurator tables and lists are flexible with several options for how to display their entries.

Click a column heading to sort the table's entries according to that column's criteria.

Figure 10 Sorting Table Entries by a Column's Criteria

Status	Name ↑	Description	IP/Netmask	Type	Ports
<input type="checkbox"/>	ge1			Ethernet	p1
<input type="checkbox"/>	ge2			Ethernet	p2

Click the Resize icon () to adjust how to display column entries. If you manually adjusted the width of the columns, click **Reset** to return them to the original widths. If you have a big monitor and want to see complete information in each column field, click **Fit Content**. If your monitor is not so big and you want to see all columns in the screen, click **Fit View**.

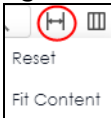
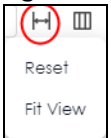
Figure 11 Fit Content**Figure 12** Fit View

Click the column icon () for more options about how to display the entries. The options available vary depending on the type of fields in the column. You can select which columns to display by selecting or clearing the check box. The tables have icons for working with table entries.

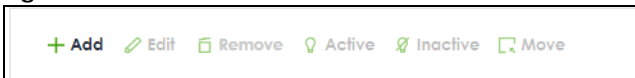
Figure 13 Common Table Icons

1.6.6 Error /Warning Messages

The following are some error or warning messages that may appear on your Zyxel Device.

1.6.6.1 Parsing/Timeout Error

Some screens may display an error message if there is a parsing or time-out error. Use **Test in Maintenance > Firmware/File Manager > Configuration** to see if the currently running configuration file has an error.

Figure 14 Parsing Error**Figure 15** Timeout Error

1.6.6.2 Desynchronize from Nebula Security Profile Warning

Security profile sync in the Nebula Control Center (NCC) allows you to share the same Zyxel Device security service feature across multiple sites within an organization. If you enable **Security profile sync** in the NCC, and then add, edit or remove the security service feature in the web configurator, you will then see one of the following warnings.

Click **Cancel** to not apply or remove the security service feature and keep it synchronized with other sites on the NCC, or click **OK** to apply or remove the security service feature. The **Security profile sync** will then be disabled on the NCC.

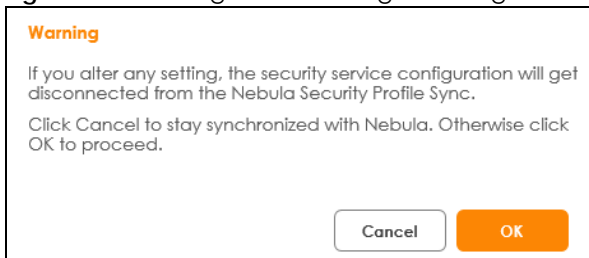
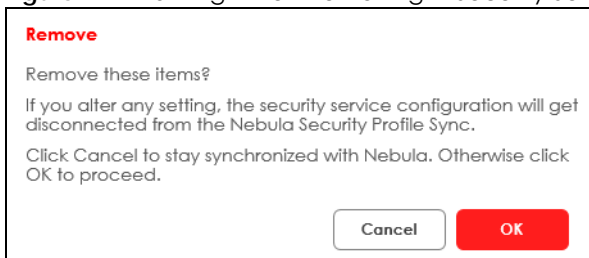
Figure 16 Warning When Adding or Editing A Security Service Feature**Figure 17** Warning When Removing A Security Service Feature

CHAPTER 2

Initial Setup Wizard

2.1 Initial Setup Wizard Overview

When you log into the Web Configurator for the first time or when you reset the Zyxel Device to its default configuration, the **Initial Setup Wizard** screen displays. This wizard helps you configure Internet connection settings and activate subscription services.

Note: You must register your Zyxel Device at Nebula Control Center (NCC) to use security services and upgrade firmware. NCC is an Internet portal that allows you to monitor and manage groups of Zyxel Devices in organizations.

This chapter provides information on configuring the Web Configurator's **Initial Setup Wizard**. See the feature-specific chapters in this User's Guide for background information.

You will be logged out of the Zyxel Device initial setup wizard after 1440 minutes. The settings you configured will be saved. Log into the Zyxel Device again if you have not finished configuring the initial setup wizard settings.

Click **Next** to continue the wizard. Click **Finish** at the end of the wizard to complete the wizard.

2.1.1 Terms of Use/Privacy Policy/Firmware Upgrade Notification

Click the links to see:

- What data Zyxel collects from you and how it is used
- Zyxel privacy policy.

Please also read the firmware upgrade notification carefully.

To use SecuReporter and sandbox, you need to allow Zyxel to collect data from you.

Select **I have read and agree with the items above**. SecuReporter and sandbox will be enabled automatically when you select the check box.

Click **Next** to configure the Zyxel Device settings with the initial setup wizard.

Note: You cannot proceed with the initial setup wizard if you do not select the check box.

Figure 18 Terms of Use/Privacy Policy/Mandatory Firmware Upgrade Notification

ZYXEL
NETWORKS

Please read the following items carefully as they contain important information about your legal rights.

Terms of Use Read →

Privacy Policy Read →

Mandatory Firmware Upgrade Notification

Sometimes, networking threats occur that can seriously compromise the security of your network. Zyxel will react immediately to release patch firmware that will combat these serious threats. This firmware upgrade is mandatory and Zyxel will notify you of a time frame to upgrade the firmware.

I have read and agree with the items above.

Next

2.2 Connect to the Internet

Use this screen to set the interface's type of encapsulation and method of IP address assignment.

The screens vary depending on the encapsulation type. Refer to information provided by your ISP to know what to enter in each field.

Go to **Network > Interface** after you log into the web configurator if you want to change the interface settings.

Note: Enter the Internet access information exactly as your ISP gave it to you. Leave a field blank if you don't have that information.

2.2.1 Interface Type - DHCP

Use this screen to configure your IP address settings.

- **Interface Type:** This displays the type of Internet connection you are configuring. Select DHCP if your ISP did not assign you a fixed IP address.
- **Port:** Select a port to apply the Internet connection settings to.
- **IP Address:** This field is read-only when you set **Interface Type** to **DHCP**.
- **DHCP Option 60:** DHCP Option 60 is used by the Zyxel Device for identification to the DHCP server using the VCI (Vendor Class Identifier) on the DHCP server. The Zyxel Device adds it in the initial DHCP discovery message that a DHCP client broadcasts in search of an IP address. The DHCP server can assign different IP addresses or options to clients with the specific VCI or reject the request from clients without the specific VCI.

Type a string using up to 63 of these characters a-zA-Z0-9!\'#\$%&'()*+,-./:;<=>?@[^_`{} to identify this Zyxel Device to the DHCP server. For example, Zyxel-TW.

- **VLAN Tag:** Enable to tag the traffic going out from the Zyxel Device.

- **VLAN ID:** Enter a VLAN ID. This 12-bit number uniquely identifies each VLAN. Allowed values are 1-4080.
- **Connection Test:** Click **Connection Test** to check that you can access the Internet. If you cannot, click **Back** and confirm that you entered the settings correctly. If you have, check that you got the correct settings from your ISP or network administrator.

Figure 19 Interface Type - DHCP

The screenshot shows the 'Connect To Internet' configuration screen. On the left is a vertical navigation pane with six steps: 1. Connect To Internet (highlighted), 2. System Time, 3. Device Registration, 4. License Summary, 5. Subnet Planning, and 6. Finish. The main area is titled 'Connect To Internet' and contains the following settings:

- Interface Type:** A dropdown menu set to 'DHCP'.
- Port:** A dropdown menu set to 'p1'.
- Address Assignment:** A section containing:
 - IP Address:** A text input field with a green refresh icon to its right.
 - DHCP Option 60:** An empty text input field.
 - VLAN Tag:** A toggle switch that is currently turned off.
- Connection Test:** A green button with a green checkmark and the text 'Pass' next to it.

At the bottom right of the screen is a green 'Next' button.

2.2.2 Interface Type - Static

Use this screen to configure your IP address settings.

- **Interface Type:** This displays the type of Internet connection you are configuring. Select **Static** if your ISP assigned you a fixed IP address.
- **Port:** Select a port to apply the Internet connection settings to.
- **WAN IP:** Enter your (static) public IP address.
- **Subnet Mask:** Enter the subnet mask for this WAN connection's IP address.
- **Default Gateway:** Enter the IP address of the router through which this WAN connection will send traffic (the default gateway).
- **First / Second DNS Server:** These fields display if you selected static IP address assignment. The Domain Name System (DNS) maps a domain name to an IP address and vice versa. Enter a DNS server's IP address(es). The DNS server is extremely important because without it, you must know the IP address of a computer before you can access it. The Zyxel Device uses these (in the order you specify here) to resolve domain names for VPN, DDNS and the time server. Leave the field as 0.0.0.0 if you do not want to configure DNS servers.
- **VLAN Tag:** Enable to tag the traffic going out from the Zyxel Device.
- **VLAN ID:** Enter a VLAN ID. This 12-bit number uniquely identifies each VLAN. Allowed values are 1-4080.

- **Connection Test:** Click **Connection Test** to check that you can access the Internet. If you cannot, click **Back** and confirm that you entered the settings correctly. If you have, check that you got the correct settings from your ISP or network administrator.

Figure 20 Interface Type - Static

The screenshot shows the 'Connect To Internet' configuration screen. On the left, a vertical sidebar lists five steps: 1. Connect To Internet (highlighted in green), 2. System Time, 3. Device Registration, 4. License Activation, and 5. Finish. The main area is titled 'Connect To Internet' and contains the following fields:

- Interface Type:** A dropdown menu set to 'Static'.
- Port:** A dropdown menu set to 'p1'.
- Address Assignment:** A label for the section.
- WAN IP:** An empty text input field with a red border and a red error message below it: 'The value should be an IP address.'
- Subnet Mask:** An empty text input field with a red border and a red error message below it: 'The value should be a subnet mask.'
- Default Gateway:** An empty text input field with a red border and a red error message below it: 'The value should be an IP address.'
- First DNS Server:** An empty text input field.
- Second DNS Server:** An empty text input field.

A green 'Next' button is located at the bottom right of the form.

2.2.2.1 Possible Errors

- Check that the cable is connected from the WAN port (port 1 or port 2) to the Internet.
- Check that the interface is connected to the device you're using for Internet access such as a broadband router, and that the router is turned on.
- If your Zyxel Device was not able to obtain an IP address, check that your Internet access information uses DHCP as the WAN connection type. If it fails again, check with your Internet service provider or administrator for correct WAN settings.
- If your Zyxel Device was not able to use the IP address entered, check that you enter correctly the IP address, subnet mask and gateway IP address exactly as given. If it fails again, check with your Internet service provider or administrator for the correct IP address, subnet mask and gateway address and other WAN settings.

2.2.3 Interface Type - PPPoE

Use this screen to configure your IP address settings.

- **Interface Type:** This displays the type of Internet connection you are configuring. Select **PPPoE** for a dial-up connection according to the information from your ISP.
- **Port:** Select a port to apply the Internet connection settings to.
- **User Name:** Enter the user name given to you by your ISP. You can use up to 64 single-byte characters, including 0-9a-zA-Z-_\$. /+ # ; :% \ ~ ^ & * () " = { } [] | ? , < ' > '!. Spaces are not allowed.
- **Password:** Enter the password associated with the user name. You can use up to 63 single-byte characters, including 0-9a-zA-Z-_\$. /+ # ; :% \ ~ ^ & * () " = { } [] | ! , < ' > '!. Spaces are not allowed. This field cannot be blank.

- **VLAN Tag:** Enable to tag the traffic going out from the Zyxel Device
- **VLAN ID:** Enter a VLAN ID. This 12-bit number uniquely identifies each VLAN. Allowed values are 1-4080.
- **Connection Test:** Click **Connection Test** to check that you can access the Internet. If you cannot, click **Back** and confirm that you entered the settings correctly. If you have, check that you got the correct settings from your ISP or network administrator.

Figure 21 Interface Type - PPPoE

2.2.3.1 Possible Errors

Make sure that your Internet access information uses PPPoE as the WAN connection type. Re-enter your PPPoE user name and password exactly as given. If it fails again, check with your Internet service provider or administrator for correct WAN settings and user credentials.

2.3 System Time

It's important to have correct date and time values in the logs. The Zyxel Device can automatically update the time and date by detecting your time zone and whether Daylight Savings is in effect in that time zone.

If your Zyxel Device cannot get the correct date and time, it may not be able to connect to a time server. Check the time server settings in **System > Settings** after you log into the Zyxel Device.

Figure 22 System Time

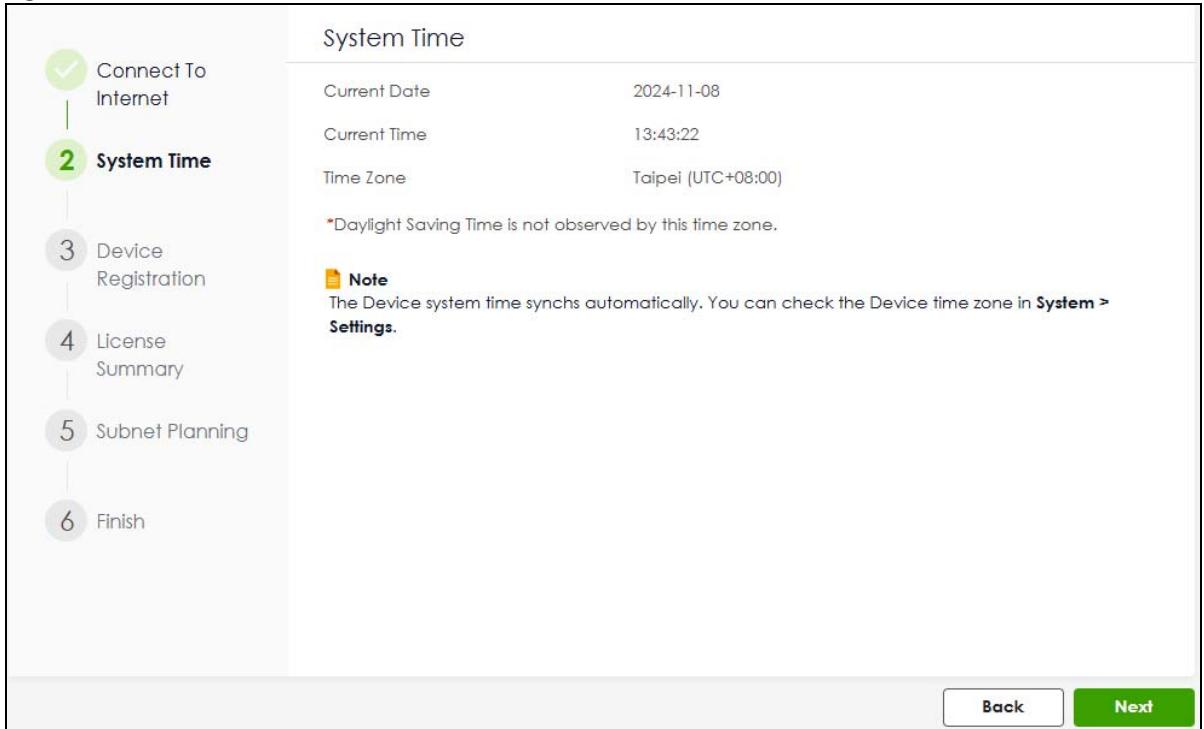

2.4 Device Registration

Device registration includes:

- Adding your Zyxel Device to a site in an organization at [NCC](#)
- Activating Zyxel Device service licenses

If you previously activated your service licenses at another Zyxel portal such as myZyxel.com or Circle, you can still use all Zyxel Device services except for SecuReporter and remote support through Nebula. Add your Zyxel Device to a site in an organization at [NCC](#) to be able to use these features also.

If you did not previously activate your service licenses at another Zyxel portal such as myZyxel.com or Circle, then you must add your Zyxel Device to a site in an organization at [NCC](#) in order to activate your Zyxel Device service licenses, including SecuReporter, perform firmware upgrades and avail of remote support through Nebula.

After you successfully register your Zyxel Device, security services supported by your model will be activated automatically.

Click the **Register** button in this screen to add your Zyxel Device to a site in an organization at Nebula. There are two ways to add your Zyxel Device to a site at [NCC](#).

- Automatically add it by scanning the QR code to use the Nebula Mobile app.
- Manually add it by entering the Zyxel Device's serial number and LAN MAC address at [NCC](#). See the label at the back of the Zyxel Device for this information.

Note: The Zyxel Device must be connected to the Internet in order to connect to [NCC](#).

Click **Refresh** or use the **Licensing > Licenses** screen after you log into the web configurator to have the Zyxel Device connect to [NCC](#) to update its registration status.

The **Registration Status** field may display **Registered** or **Not registered**.

- **Registered:** Your Zyxel Device has been successfully added to a site in [NCC](#).
- **Not registered:** Your Zyxel Device has not been successfully added to a site in [NCC](#). Make sure the Zyxel Device is connected to the Internet. Wait a few minutes, then click **Refresh** to synchronize again.

Figure 23 Register Device

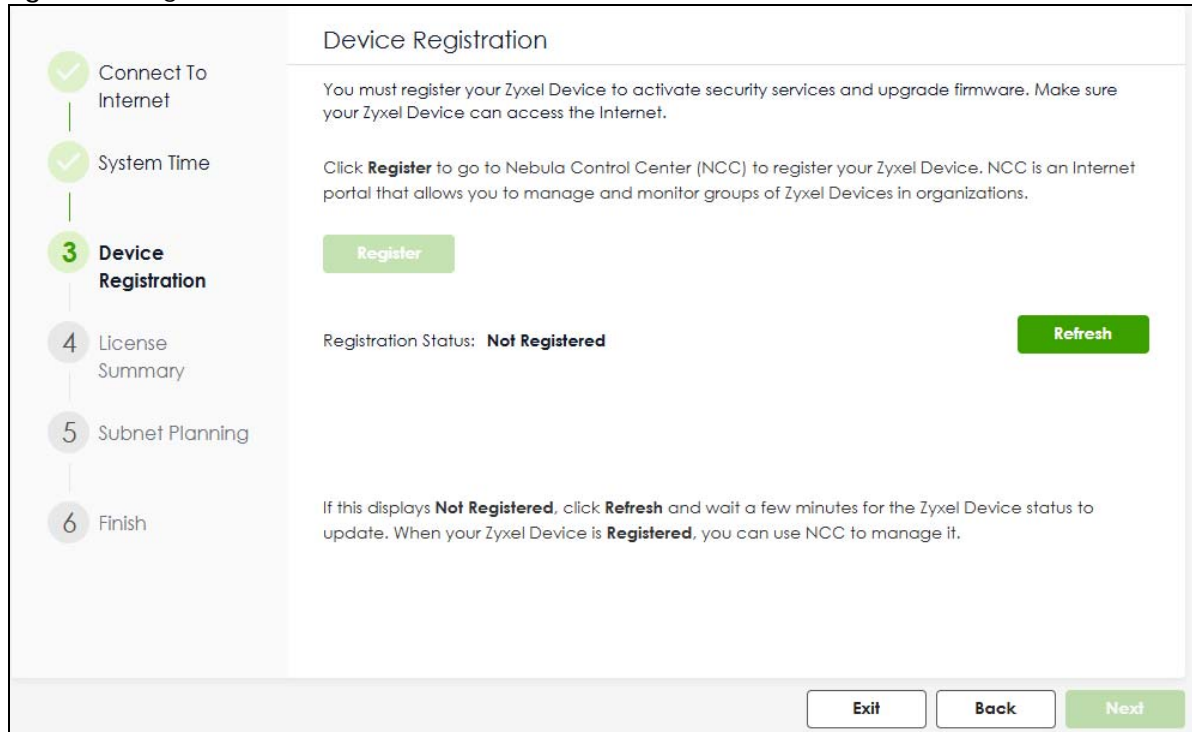

2.4.1 Exit the Wizard

The **Exit** button displays if the Zyxel Device is not connected to the Internet when you are at the **Device Registration** step. You will be redirected to the Zyxel Device login page after you click **Exit**.

If you did not previously activate your service licenses at another Zyxel portal, then you must add your Zyxel Device to a site in an organization at [NCC](#) in order to activate your Zyxel Device service licenses, including SecuReporter, perform firmware upgrades and avail of remote support through Nebula.

Figure 24 Exit Wizard

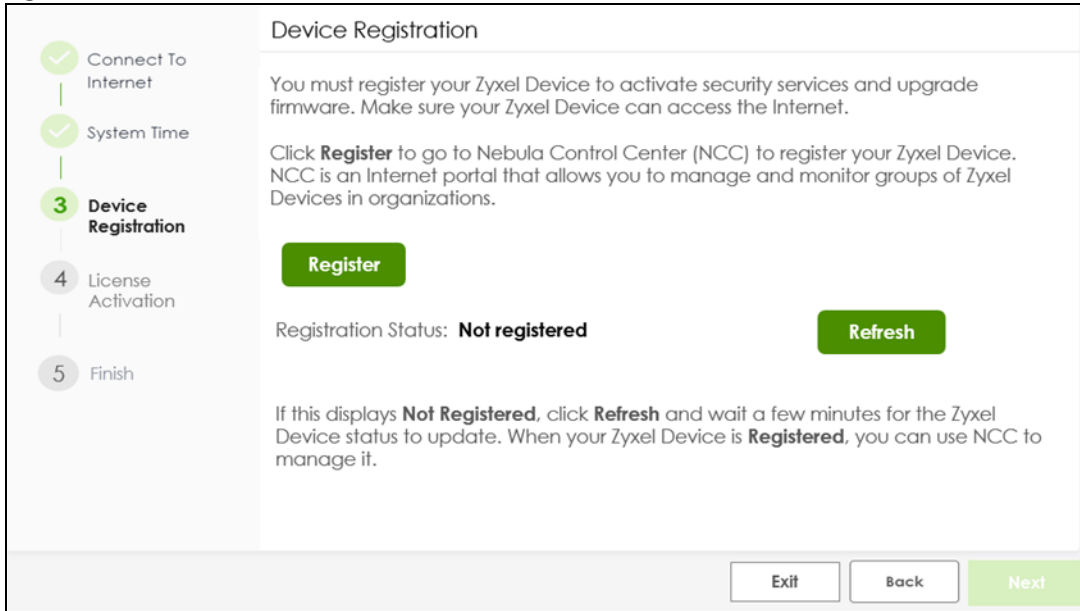

Make sure to go to **Licensing > Licenses** and follow the instructions to register your Zyxel Device once your Zyxel Device is connected to the Internet. Please note that you will only see the following screen if you log in using an admin account.

Figure 25 Licensing > Licenses

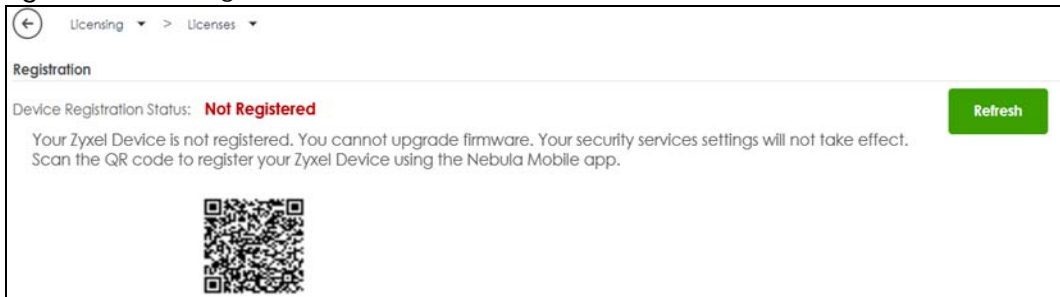

You will also see a warning message to remind you to register your Zyxel Device every time you log into the web configurator. Please note that you will only see the warning message if you log in using an admin account.

Figure 26 Register Warning Message



2.5 License Summary

After you successfully register your Zyxel Device, security services supported by your model will be activated automatically.

Go to **Licensing > Licenses** after you log into the web configurator if you want to check the Zyxel Device services status.

Figure 27 Service Activation

Service	Status	Expiration
Application Patrol Trial	Expired	2024/06/16
Sandboxing Trial	Expired	2024/06/16
Web Filtering Trial	Expired	2024/06/16
Anti-Malware Trial	Expired	2024/06/16
Reputation Filter Trial	Expired	2024/06/16
Security Profile Sync Trial	Expired	2024/06/16
SecuReporter Trial	Expired	2024/06/16
Nebula Professional Pack Trial	Expired	2024/06/16
Device Insight Trial	Expired	2024/06/16
IPS Trial	Expired	2024/06/16

Click **Refresh** and wait a few moments for the registration information to update in this screen. If the page does not refresh, make sure the Internet connection is working and click **Refresh** again. To check your Internet connection, try to access the Internet from a computer connected to a LAN port on the Zyxel Device. If you cannot, then check your Internet access settings on the Zyxel Device.

The **Status** column may display **Activated** or **Expired**.

- **Activated:** The service license is enabled.
- **Expired:** The service license has expired. Go to **NCC > Organization-wide > License & Inventory** to renew your license.

2.6 Subnet Planning

You must register your Zyxel Device to an organization and site in the Nebula Control Center (NCC) to see this screen.

Figure 28 Subnet Planning

Connect To Internet

System Time

Device Registration

License Summary

5 Subnet Planning

6 Finish

Subnet Planning

Nebula VPN automatically create and provision VPN tunnels to all Nebula firewalls within the same organization.

To avoid IP subnet conflicts among Nebula firewalls participating VPNs, the Auto Subnet Planning feature replaces default subnets of ge3/ge4 with non-overlapping subnets.

Organization Name: Fran-Org
Site Name: Fran-site

Enable Auto Subnet Planning?

Yes, let Nebula adjust subnets of ge3/ge4.

New Interface IP and Subnet Information

Name	Default	New
ge3	192.168.118.1/23	192.168.144.1/23
ge4	192.168.169.1/24	192.168.118.1/23

No, I prefer to keep using default subnets of ge3/ge4.

Click **Finish** to apply new Subnet and exit the wizard.

Back
Finish

In the following figure, if internal networks **A** and **B** in your organization use the same private IP address, they will not be able to communicate with each other through Nebula VPN, as traffic will be routed locally and not through the Zyxel Device. To avoid this, you must manually configure different private IP address ranges for all internal networks in your organization, or let NCC automatically do it (recommended).

Figure 29 IP Address Conflict Causing VPN Failure

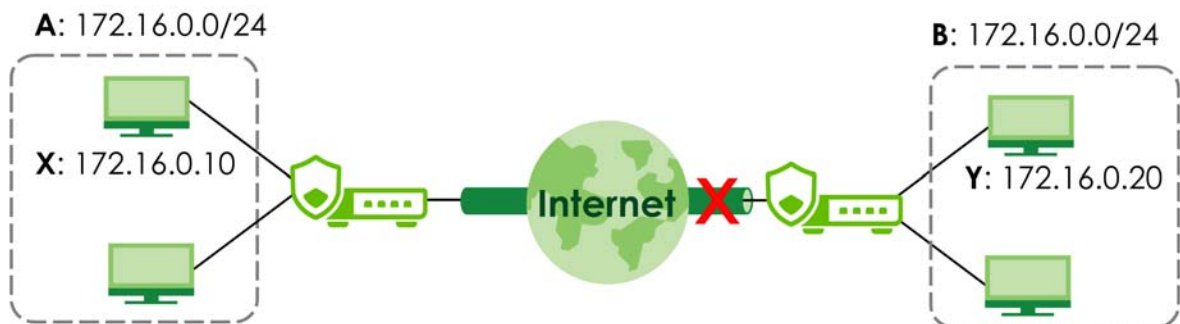

Use this screen to select the subnet configuration for the Zyxel Device:

Select **Yes, let Nebula adjust subnets of ge3/ge4** to have the NCC assign a private IP address to your Zyxel Device. Select this if you want your Zyxel Device to join the organization's VPN through the NCC. The assigned IP address will be different from those used by local networks behind other Zyxel Devices in the organization's VPN.

Note: If you apply **Yes, let Nebula adjust subnets of ge3/ge4**, your computer will be temporarily disconnected from the Zyxel Device. Wait 10 seconds for the Zyxel Device to apply the IP address assigned by the NCC.

Note: If your computer is not directly connected to the Zyxel Device, you need to renew the IP address manually or disconnect and reconnect the Ethernet cable to update the IP address.

Select **No, I prefer to keep using default subnets of ge3/ge4** to use the existing IP addresses assigned to the local network behind this Zyxel Device. Select this if you don't want your Zyxel Device to join the organization's VPN through the NCC.

If you want your Zyxel Device to join the organization's VPN through the NCC in the future, ensure that this Zyxel Device's IP address is different from the ones used by local networks behind other Zyxel Devices participating in the organization's VPN.

2.7 Finish

Click **Finish** to save all settings to the Zyxel Device and leave the initial wizard.

- To manage security services and policies on this Zyxel Device, log into the Zyxel Device web configurator.
- To monitor and manage your Zyxel Devices through the cloud, click **Nebula Control Center (NCC)**.

Note: If you want to run the initial wizard again, you must reset the Zyxel Device. Make sure to back up your current configuration first as you will lose all web configurator settings after the reset.

Figure 30 Finish

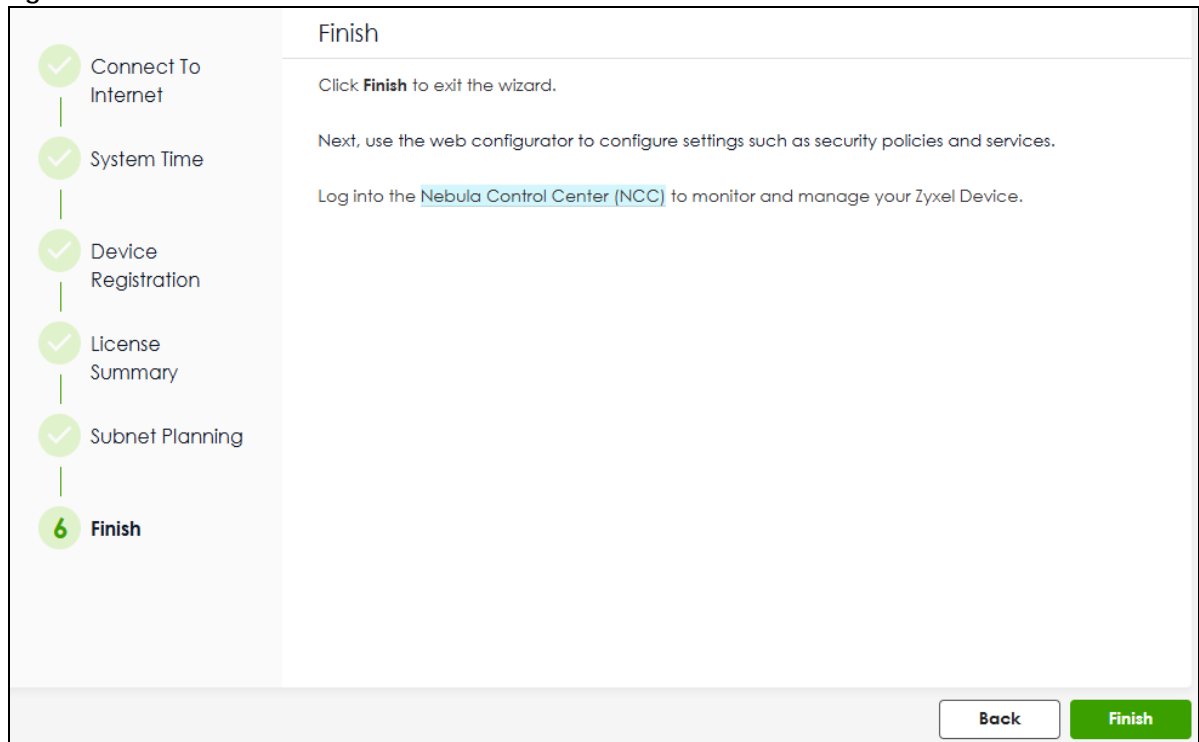

CHAPTER 3

Hardware, Interfaces and Zones

3.1 Hardware Overview

This section describes the front and rear panels for each model.

The following table summarizes the port features of the Zyxel Device by model.

Table 9 USG FLEX Series Port Comparison Table

USG FLEX MODELS	USG FLEX 50H	USG FLEX 50HP	USG FLEX 100H	USG FLEX 100HP	USG FLEX 200H	USG FLEX 200HP	USG FLEX 500H	USG FLEX 700H
USB 3.0 Ports	1	1	1	1	1	1	1	1
10 Gbps SFP+ interface	0	0	0	0	0	0	0	2
PoE+ Port	0	1	0	1	0	1	2	2
10/100/1000 Mbps Ethernet Ports	5	5	8	8	6	6	8	8
Multi-Gigabit Ethernet Ports	0	0	0	0	2	2	4	4
Console Port	1 (RJ45)	1 (RJ45)	1 (RJ45)	1 (RJ45)	1 (RJ45)	1 (RJ45)	1 (RJ45)	1 (RJ45)

For information on interface names by model, default port or interface name mapping, and default interface or zone mapping please see [Section on page 62](#).

3.1.1 Multi-Gigabit

Multi-Gigabit Ethernet ports automatically allow connections up to the speed of the connected network device (100M, 1G, 2.5G, 5G, or 10G), and you just need to use a CAT 5e or CAT 6 Ethernet cable. You must use CAT 6A or better Ethernet cables to achieve 10G speeds.

The following table shows which models have which Multi-Gigabit ports.

Table 10 USG FLEX Series Multi-Gigabit Port Comparison

USG FLEX MODELS	USG FLEX 200H	USG FLEX 200HP	USG FLEX 500H	USG FLEX 700H
2.5 Gbps Multi-Gigabit Ethernet Ports	P1, P2	P1, P2	P1, P2, P3, P4	P1, P2
10 Gbps Multi-Gigabit Ethernet Ports				P3, P4

See the following table for the cables required and distance limitation to attain the corresponding speed.

Table 11 Cable Types

CABLE	TRANSMISSION SPEED	MAXIMUM DISTANCE	BANDWIDTH CAPACITY
Category 5	100M	100 m	100 MHz
Category 5e	1G	100 m	100 MHz
Category 6	1G / 10G	100 m:1G 37-50 m:10G	250 MHz
Category 6a	10G	100 m	500 MHz
Category 7	10G	100 m	600 MHz

3.1.2 Default Physical Port – Interface Mapping

You connect cables to the physical ports. You configure interfaces in the web configurator or command line interface (CLI).

The following table shows the default interfaces for each physical port.

Table 12 Default Physical Port – Interface Mapping

PORT / INTERFACE	P1	P2	P3	P4	P5	P6	P7	P8	P9	P10	P11	P12	P13	P14
USG FLEX 50H	ge1	ge2	ge3	ge3	ge3									
USG FLEX 50HP	ge1	ge2	ge3	ge3	ge3									
USG FLEX 100H	ge1	ge2	ge3	ge3	ge3	ge3	ge4	ge4						
USG FLEX 100HP	ge1	ge2	ge3	ge3	ge3	ge3	ge4	ge4						
USG FLEX 200H	ge1	ge2	ge3	ge3	ge3	ge3	ge4	ge4						
USG FLEX 200HP	ge1	ge2	ge3	ge3	ge3	ge3	ge4	ge4						
USG FLEX 500H	ge1	ge2	ge3	ge3	ge3	ge3	ge4	ge4	ge4	ge4	-	-		
USG FLEX 700H	ge1	ge2	ge3	ge3	ge3	ge3	ge4	ge4	ge4	ge4	-	-	-	-

Note: You change the default zone for all interfaces in **Network > Interface and Object > Zone**.

The following shows the default zone for each interface.

- ge1 and ge2 are WAN ports
- ge3 and ge4 are LAN ports
- '-' means these ports have no default zone, so you must configure a zone for them in **Network > Interface and Object > Zone**

3.1.3 PoE

The Zyxel Device is a Power Sourcing Equipment (PSE) because it provides a source of power through its Ethernet ports. Each device that receives power through an Ethernet port is a Powered Device (PD). A Powered Device (PD) is a device that receives power through PoE, such as an IP camera, a wireless router, an IP telephone or a general outdoor router.

Note: Do not connect the Zyxel Device PoE+ port to a non-Powered Device. If you need to connect a non-Powered Device to the Zyxel Device PoE port, make sure to disable PoE in **Network > Interface > Port** first.

The following example figure shows a Zyxel Device supplying PoE (Power over Ethernet) to PDs that are not within reach of a power outlet.

Figure 31 PoE Application

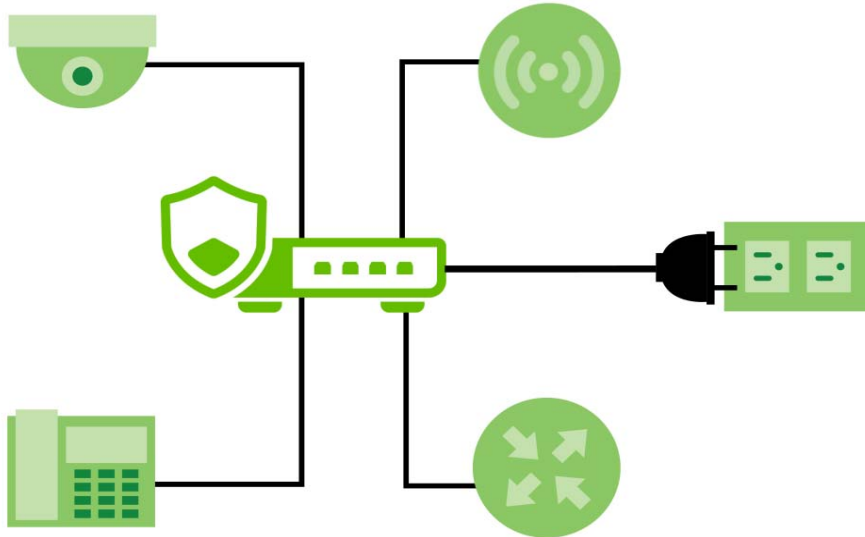

The Zyxel Device can adjust the power supplied to each PD according to the PoE standard the PD supports. PoE standards are:

- IEEE 802.3af Power over Ethernet (PoE)
- IEEE 802.3at Power over Ethernet (PoE+)

The following table describes the PoE features of the Zyxel Device by PoE standard.

Table 13 Zyxel Device PoE Features

POE FEATURES	USG FLEX 50HP	USG FLEX 100HP	USG FLEX 200HP	USG FLEX 500H	USG FLEX 700H
IEEE 802.3 at PoE+	Port 5	Port 8	Port 2	Port 3-4	Port 3-4
Power Management Mode	Consumption	Consumption	Consumption	Consumption	Consumption
PoE Power Budget	30W	30W	30W	30W	30W

Table 14 PoE Standards

POE FEATURES	POE	POE+
IEEE Standard	IEEE 802.3af	IEEE 802.3at
PoE Type	Type 1	Type 2
Switch Port Power		
IEEE Power Classification	Class 0, 1, 2, 3	Class 4
Maximum Power Per Port	15.4 W	30 W
Port Voltage Range	44 - 57 V	50 - 57 V
Cables		

Table 14 PoE Standards

POE FEATURES	POE	POE+
Twisted Pairs Used	2-pair	2-pair
Supported Cables	Cat3 or Cat5	Cat5 or better

3.1.4 Front Panels

The LED indicators are located on the front panel.

Figure 32 USG FLEX 50H Front Panel

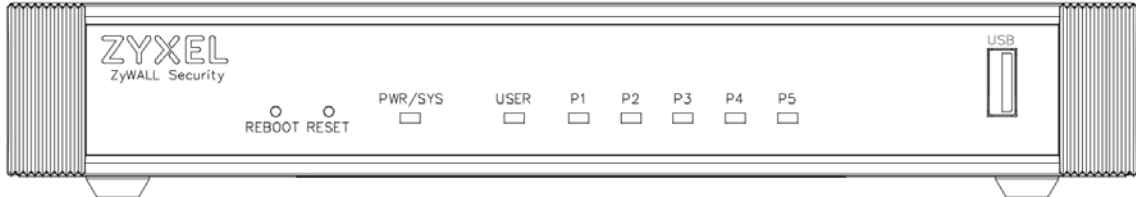

Figure 33 USG FLEX 50HP Front Panel

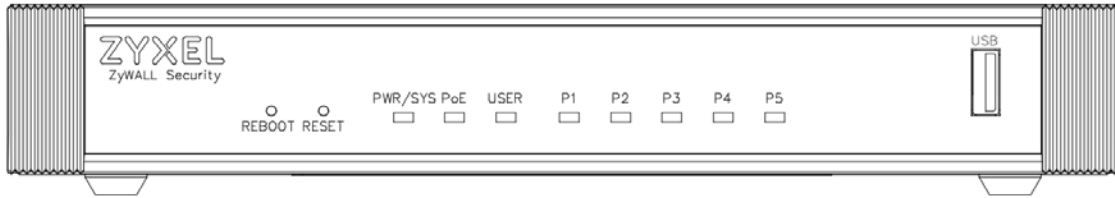

Figure 34 USG FLEX 100H Front Panel

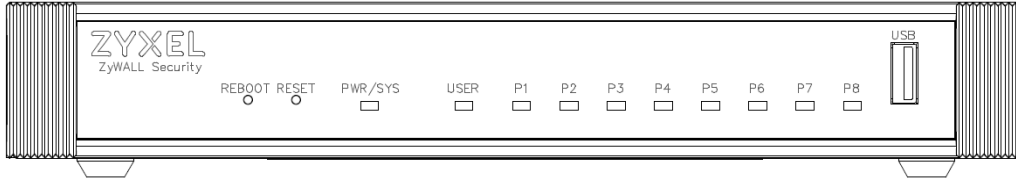

Figure 35 USG FLEX 100HP Front Panel

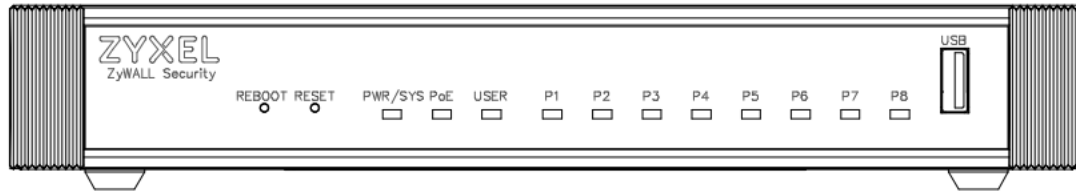

Figure 36 USG FLEX 200H Front Panel

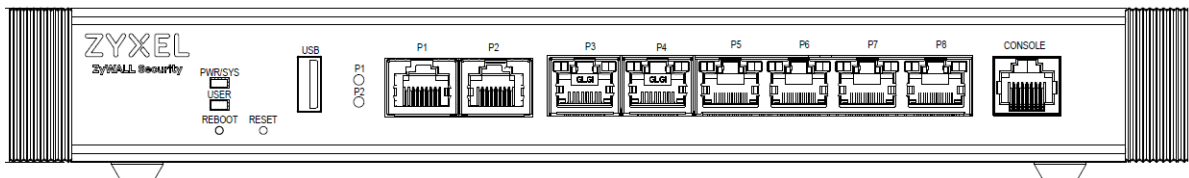

Figure 37 USG FLEX 200HP Front Panel

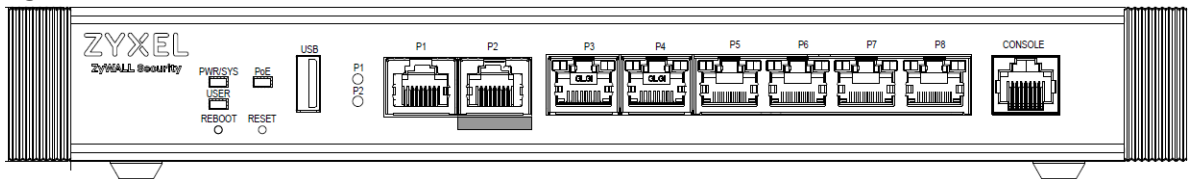

Figure 38 USG FLEX 500H Front Panel

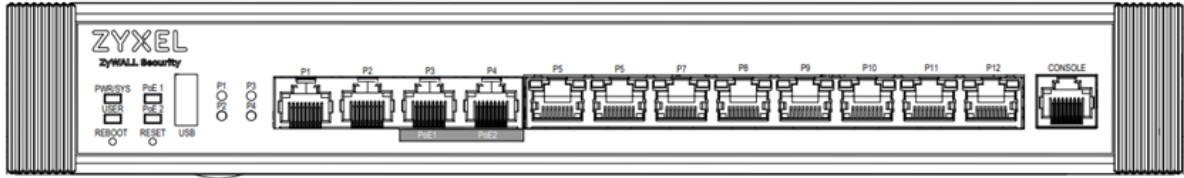
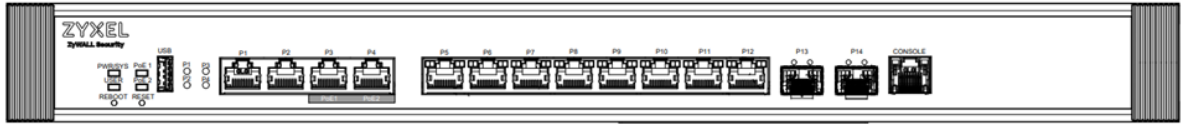

Figure 39 USG FLEX 700H Front Panel



The following table describes the front panel LEDs.

Table 15 LED Descriptions

LED	COLOR	STATUS	DESCRIPTION
PWR/SYS	Green	Off	The Zyxel Device is not ready or has failed.
		On	The Zyxel Device is ready and running.
		Blinking	The Zyxel Device is booting or upgrading firmware
	Red	On	The Zyxel Device has an error or has failed.
Blinking		The Zyxel Device is returning to factory defaults.	
USER	Green	On	There are accounts with User Type set as admin logged into the Zyxel Device.
		Blinking	New firmware is available or your license has expired.
	Amber	On	There are IP addresses locked out of the Zyxel Device.
		Off	USER LED is not enabled in System > Settings .
PoE (PoE1/PoE2)	Green	On	The PoE connected to this port is in AT mode (PoE AT enabled).
	Amber	On	The PoE connected to this port is in AF mode (PoE AF enabled)
		Off	No PoE is connected to this port (PoE disabled).
P1-P5 (USG FLEX 50H / 50HP); P1-P8 (USG FLEX 100H / 100HP) P3-P8 (USG FLEX200 / 200HP) P5-P12 (USG FLEX 500H / 700H)	Amber	On	This port has a successful 10/100 Mbps link.
		Blinking	The Zyxel Device is sending or receiving packets on this port at 10/100 Mbps.
	Green	On	This port has a successful 1 Gbps link.
		Blinking	The Zyxel Device is sending or receiving packets on this port at 1 Gbps.
	Off	There is no connection on this port.	
P1, P2 (USG FLEX 200 / 200HP) P1-P4 (USG FLEX 500H)	Sky Blue	On	This port has a successful 2.5 Gbps link.
		Blinking	The Zyxel Device is sending or receiving packets on this port at 2.5 Gbps.
	Green	On	This port has a successful 1 Gbps link.
		Blinking	The Zyxel Device is sending or receiving packets on this port at 1 Gbps.
	Amber	On	This port has a successful 100 Mbps link.
		Blinking	The Zyxel Device is sending or receiving packets on this port at 100 Mbps.
	Off	There is no connection on this port.	

Table 15 LED Descriptions (continued)

LED	COLOR	STATUS	DESCRIPTION
P3, P4 (USG FLEX 700H)	Blue	On	This port has a successful 10 Gbps link.
		Blinking	The Zyxel Device is sending or receiving packets on this port at 10 Gbps.
	Purple	On	This port has a successful 5 Gbps link.
		Blinking	The Zyxel Device is sending or receiving packets on this port at 5 Gbps.
	Sky Blue	On	This port has a successful 2.5 Gbps link.
		Blinking	The Zyxel Device is sending or receiving packets on this port at 2.5 Gbps.
	Green	On	This port has a successful 1 Gbps link.
		Blinking	The Zyxel Device is sending or receiving packets on this port at 1 Gbps.
	Amber	On	This port has a successful 100 Mbps link.
		Blinking	The Zyxel Device is sending or receiving packets on this port at 100 Mbps.
	Off	There is no connection on this port.	
P13, P14 SPF+ (USF FLEX 700H)	Blue	On	This port has a successful 10 Gbps link.
		Blinking	The Zyxel Device is sending or receiving packets on this port at 10 Gbps.
	Green	On	This port has a successful 1 Gbps link.
		Blinking	The Zyxel Device is sending or receiving packets on this port at 1 Gbps.
		Off	There is no connection on this port.

The following table describes the ports on the front panel.

Table 16 Front Panel Ports

LABEL	DESCRIPTION
REBOOT	Press the button for about 5 seconds to reboot the Zyxel Device.
RESET	<p>Press the button in for about 7 seconds (or until the PWR/SYS LED starts to blink), then release it to return the Zyxel Device to the default configuration (the Login Password on the back label or 1234, the LAN IP address is 192.168.168.1 and so on).</p> <p>Note: All configuration files including those you saved on the Zyxel Device will be deleted.</p> <p>Press the button in for more than 30 seconds, then release it to return the Zyxel Device to factory defaults. The Zyxel Device PWR/SYS LED will blink green while booting up.</p>
USB	Connect a storage device for system logs and storage.
P1-P8 (USG FLEX 200H / 200HP) P1-P12 (USG FLEX 500H / 700H)	These are Multi-Gigabit 1G/2.5G/10G RJ-45 Ethernet ports.

Table 16 Front Panel Ports (continued)

LABEL	DESCRIPTION
P13-P14 (USG FLEX 700H)	These are 10G SFP+ ports.
CONSOLE	<p>You can use the console port to manage the Zyxel Device using CLI commands. You will be prompted to enter your user name and password. See the Command Reference Guide for more information about the CLI.</p> <p>When configuring using the console port, you need a computer equipped with communications software configured to the following parameters:</p> <ul style="list-style-type: none"> • Speed 115200 bps • Data Bits 8 • Parity None • Stop Bit 1 • Flow Control Off

3.1.5 Rear Panels

The connection ports are located on the rear panel.

Figure 40 USG FLEX 50H Rear Panel

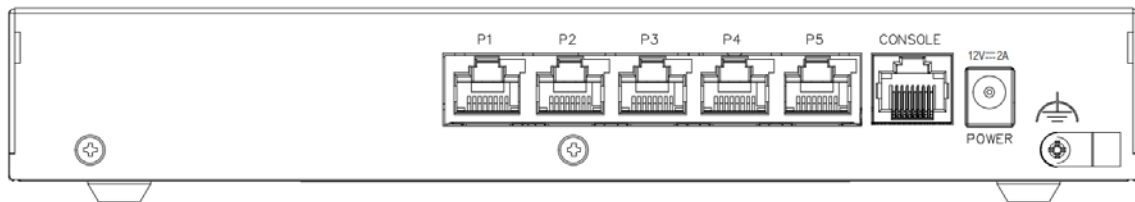

Figure 41 USG FLEX 50HP Rear Panel

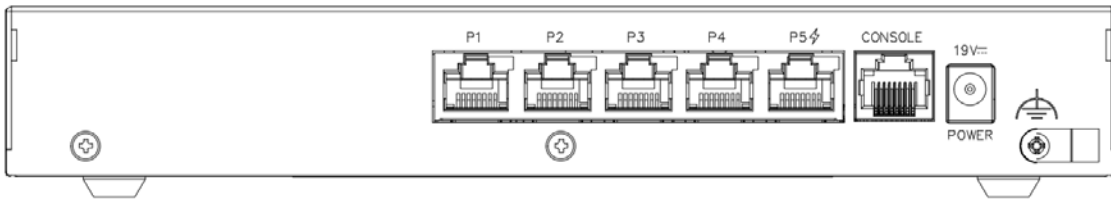

Figure 42 USG FLEX 100H Rear Panel

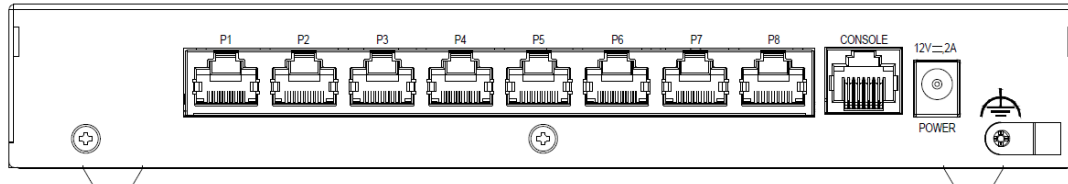

Figure 43 USG FLEX 100HP Rear Panel

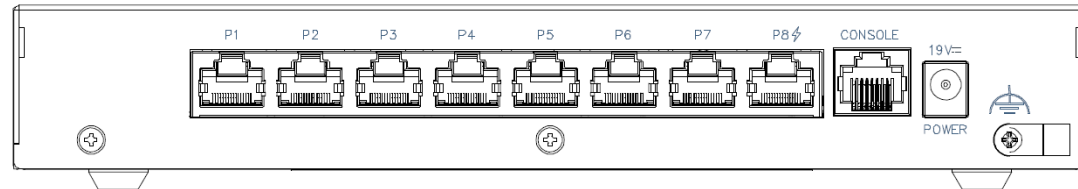

Figure 44 USG FLEX 200H Rear Panel



Figure 45 USG FLEX 200HP Rear Panel



Figure 46 USG FLEX 500H Rear Panel

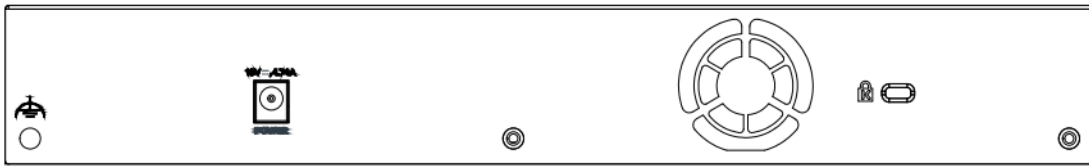
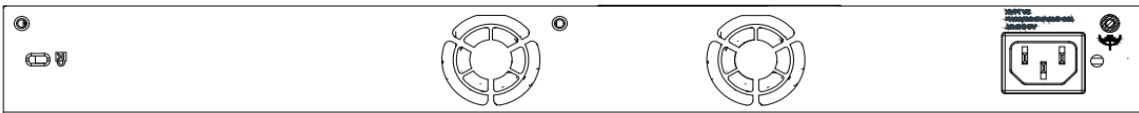

Figure 47 USG FLEX 700H Rear Panel



Note: Make sure you connect the Zyxel Device's power cord to a socket-outlet with an earthing connection or its equivalent.

The following table describes the items on the rear panel.

Table 17 Rear Panel Items

LABEL	DESCRIPTION
Power	Use the included power cord to connect the power socket to a power outlet. Turn the power switch on if your Zyxel Device has a power switch.
Console	<p>You can use the console port to manage the Zyxel Device using CLI commands. You will be prompted to enter your user name and password. See the Command Reference Guide for more information about the CLI.</p> <p>When configuring using the console port, you need a computer equipped with communications software configured to the following parameters:</p> <ul style="list-style-type: none"> • Speed 115200 bps • Data Bits 8 • Parity None • Stop Bit 1 • Flow Control Off
P1-P5 (USG FLEX 50H / 50HP) P1-P8 (USG FLEX 100H / 100HP)	These are 1G RJ-45 Ethernet ports.
Fan	The fans are for cooling the Zyxel Device. Make sure they are not obstructed to allow maximum ventilation.
Lock	Attach a lock-and-cable from the Kensington lock (the small, metal-reinforced, oval hole) to a permanent object, such as a pole, to secure the Zyxel Device in place.

Note: Use an 8-wire Ethernet cable to run your Gigabit Ethernet connection at 1000 Mbps. Using a 4-wire Ethernet cable limits your connection to 100 Mbps. Note that the connection speed also depends on what the Ethernet device at the other end can support.

3.1.6 Console Port Pin Connectors

The RJ-45 connector pins are as follows.

Figure 48 RJ-45 Connector Pins

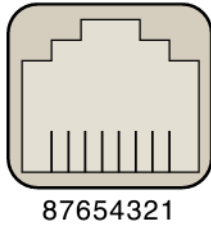

The DB-9 connector pins are as follows.

Figure 49 DB-9 Connector Pins

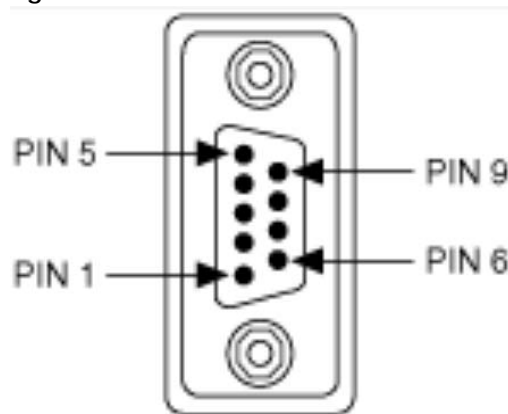

These are the cable pinouts for RJ-45 to DB-9.

Table 18 Cable Pinouts for RJ-45 to DB-9

SIGNAL	CONSOLE PORT RJ-45 PIN	DB-9 PIN	SIGNAL
RTS	1	8	CTS
DTR	2	6	DSR
TxD	3	2	RxD
GND	4	5	GND
GND	5	5	GND
RxD	6	3	TxD
DSR	7	4	DTR
CTS	8	7	RTS
		1, 9	NC

These are the signal names.

Table 19 Signal Names

SIGNAL	SIGNAL NAME
RXD	Receive Data
TXD	Transmit Data
DTR	Data Terminal Ready
GND	Ground
DSR	Data Set Ready
RTS	Request to Send
CTS	Clear to Send
RI	Ring Indicator
NC	Not Connected

3.2 Installation Scenarios

The Zyxel Device can be:

- Placed on a desktop.
- Wall-mounted on a wall.
- Rack-mounted on a standard EIA rack.

The following table summarizes the installation scenarios of the Zyxel Device by model.

Table 20 USG FLEX Series Installation Comparison Table

USG FLEX MODELS	USG FLEX 50H / 50HP	USG FLEX 100H / 100HP	USG FLEX 200H / 200HP	USG FLEX 500H	USG FLEX 700H
Rubber feet for desktop placement	Yes	Yes	Yes	Yes	Yes
Wall Mounting	Yes	Yes	Yes	No	No
Rack Mounting	No	No	No	Yes	Yes

WARNING! Do NOT block the ventilation holes on the Zyxel Device. Allow 100 mm clearance for the ventilation holes to prevent your Zyxel Device from overheating. Do not store things on the Zyxel Device. Do not place a Zyxel Device on another high temperature device. Overheating could affect the performance of your Zyxel Device, or even damage it.

3.2.1 Desktop Installation Procedure

- 1 Make sure the Zyxel Device is clean and dry.
- 2 Remove the adhesive backing from the rubber feet.

- 3 Attach the rubber feet to each corner on the bottom of the Zyxel Device. These rubber feet help protect the Zyxel Device from shock or vibration, and allow air circulation.

Figure 50 Attaching Rubber Feet

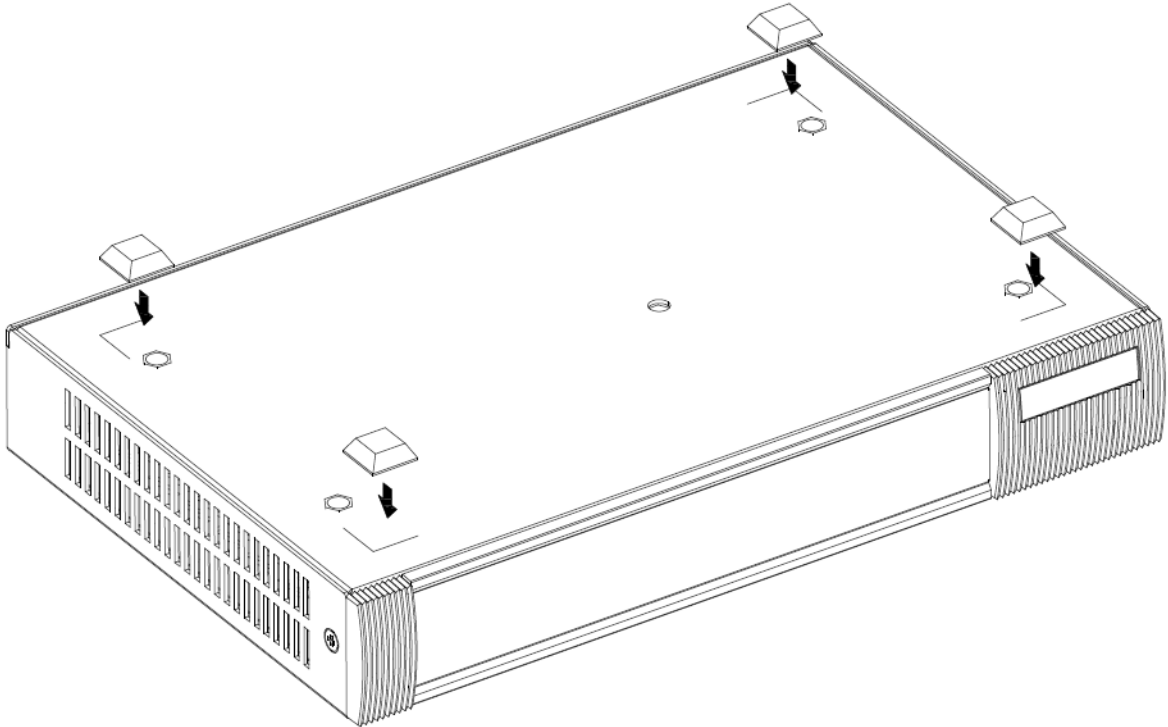

- 4 Set the Zyxel Device on a smooth, level surface strong enough to support the weight of the Zyxel Device and the connected cables. Make sure there is a power outlet nearby.

Note: Make sure to use the rubber feet when stacking the Zyxel Devices on a desk.

3.2.2 Rack-mounting

Use the following steps to mount the Zyxel Device on an EIA standard size, 19-inch rack or in a wiring closet with other equipment using a rack-mounting kit. Make sure the rack will safely support the combined weight of all the equipment it contains and that the position of the ZyWALL does not make the rack unstable or top-heavy. Take all necessary precautions to anchor the rack securely before installing the unit.

Use a #2 Phillips screwdriver to install the screws.

Note: Failure to use the proper screws may damage the unit.

- 1 Align one bracket with the holes on one side of the Zyxel Device and secure it with the included bracket screws (smaller than the rack-mounting screws).
- 2 Attach the other bracket in a similar fashion.

Figure 51 Attach Brackets

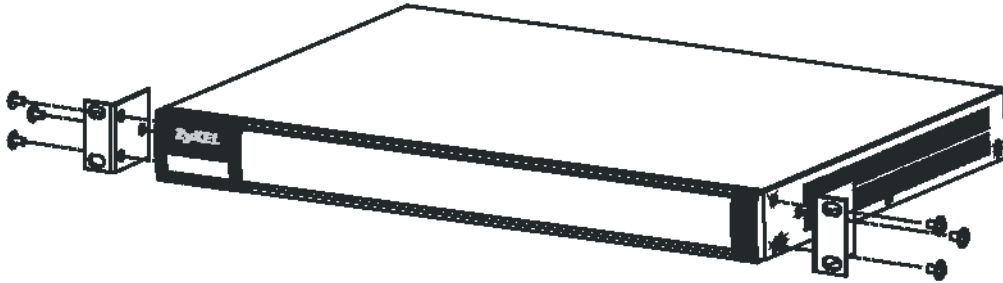

- 3 After attaching both mounting brackets, position the Zyxel Device in the rack and match up the bracket holes with the rack holes. Secure the Zyxel Device to the rack with the rack-mounting screws.

Figure 52 Mount on Rack

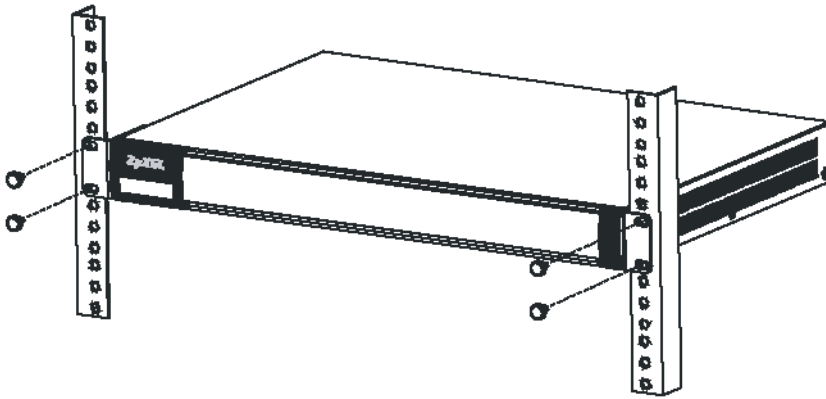

Note: Make sure there is at least 100 mm of clearance at the sides and 100 mm in the rear to allow air circulation and the attachment of cables and the power cord. When stacking in a rack, make sure there is at least 40 mm of clearance between Zyxel Devices.

3.2.3 Wall-mounting

Do the following to attach your Zyxel Device to a wall.

The following table lists the distance "X" between mounting holes for each model:

Table 21 Distance "X" Between FLEX Mounting Holes

MODEL NAME	DISTANCE "X"
USG FLEX 50H	174 mm (6.85")
USG FLEX 50HP	174 mm (6.85")
USG FLEX 100H	174 mm (6.85")
USG FLEX 100HP	174 mm (6.85")
USG FLEX 200H	206 mm (8.11")
USG FLEX 200HP	206 mm (8.11")

- 1 Drill into a wall two holes 3 mm – 4 mm (0.12" – 0.16") wide, 20 mm – 30 mm (0.79" – 1.18") deep and a distance X (see the preceding table) apart. Place two screw anchors in the holes.

Figure 53 Wall Mounting Screw Specifications

unit: mm
 D = 6.5~7.5
 H = 1.5
 L = 20~30
 d = 3.0~4.0

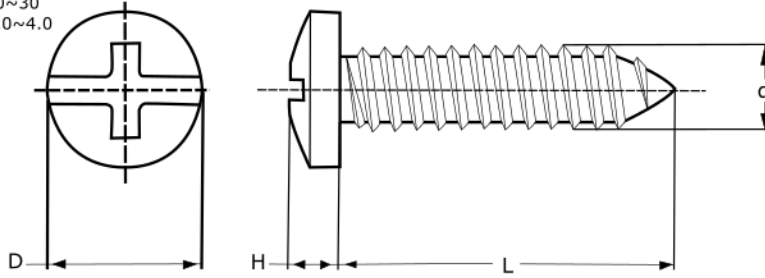

- 2 Screw two screws with 6 mm – 8 mm (0.24" – 0.31") wide heads into the screw anchors. Do not screw the screws all the way in to the wall; leave a small gap between the head of the screw and the wall.

The gap must be big enough for the screw heads to slide into the screw slots and the connection cables to run down the back of the Zyxel Device.

Note: Make sure the screws are securely fixed to the wall and strong enough to hold the weight of the Zyxel Device with the connection cables.

- 3 Use the holes on the bottom of the Zyxel Device to hang the Zyxel Device on the screws.

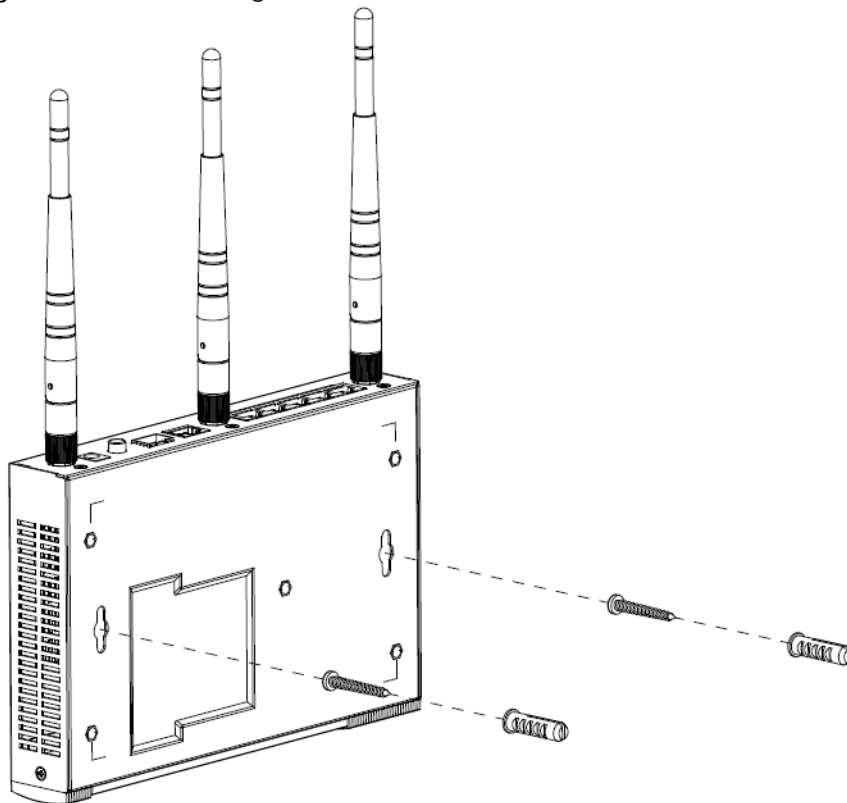
Figure 54 Wall Mounting

Note: Wall-mount the Zyxel Device horizontally. The Zyxel Device's side panels with ventilation slots should not be facing up or down as this position is less safe.

Make sure there is 100 mm of clearance at the sides and 1 – 1.5 mm distance between the screw head and the wall to allow air circulation and the attachment of cables and the power cord.

3.3 Power Cord Lock

Follow the procedures below to secure the power cord connected to the Zyxel Device.

3.3.1 Procedure A

Follow this procedure for the following models:

- USG FLEX 50H
- USG FLEX 100H
- USG FLEX 200H
- USG FLEX 500H
- USG FLEX 50HP
- USG FLEX 100HP
- USG FLEX 200HP

- 1 Use a screw driver to remove the power cord lock and the screw from the Zyxel Device.

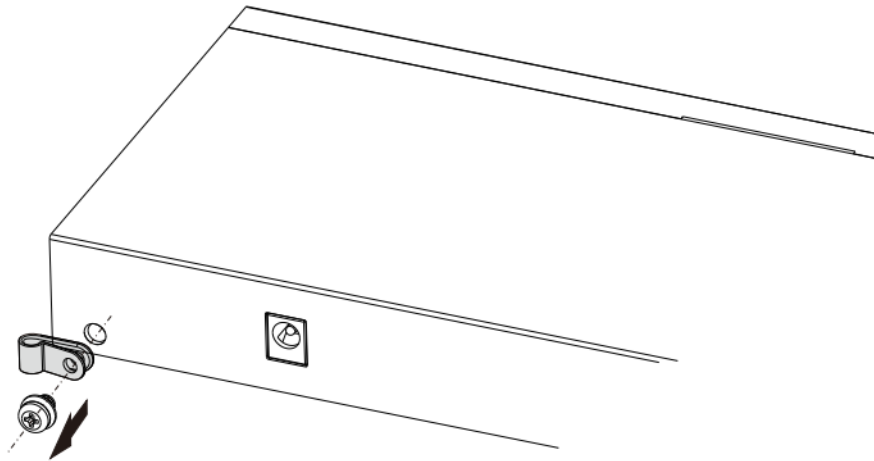

- 2 Attach the Zyxel Device power cord through the power cord lock.

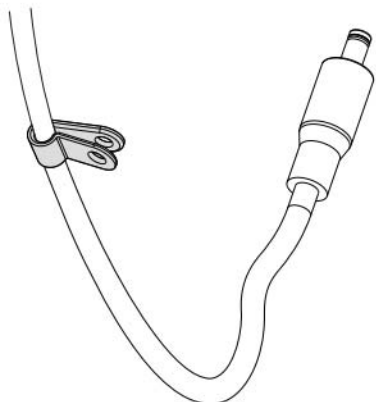

- 3 Connect the power cord to the Zyxel Device power socket.
- 4 Use the screw driver to secure the power cord lock and the screw with the power cord to the hole next to the power socket.

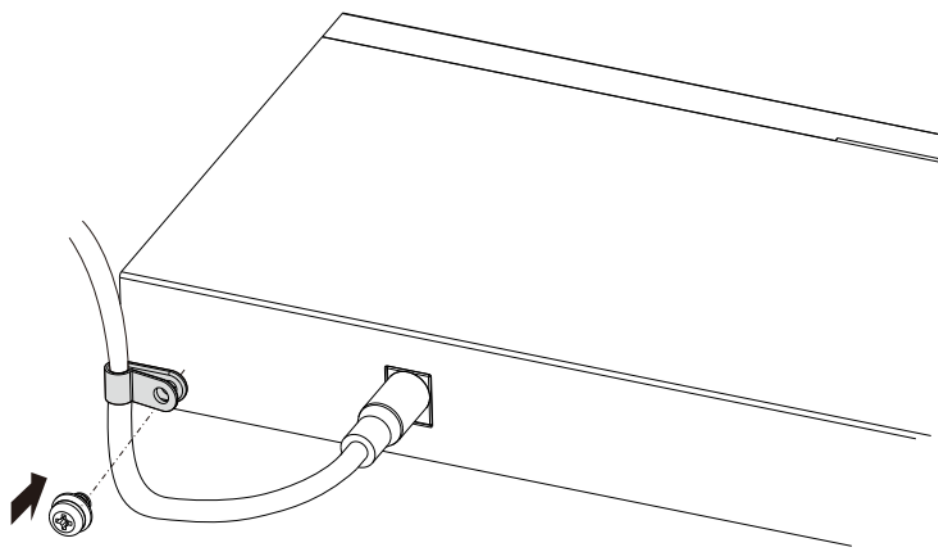

3.3.2 Procedure B

Follow this procedure for:

- USG FLEX 700H

- 1 Insert **Cable Clamp A** into the case hole.

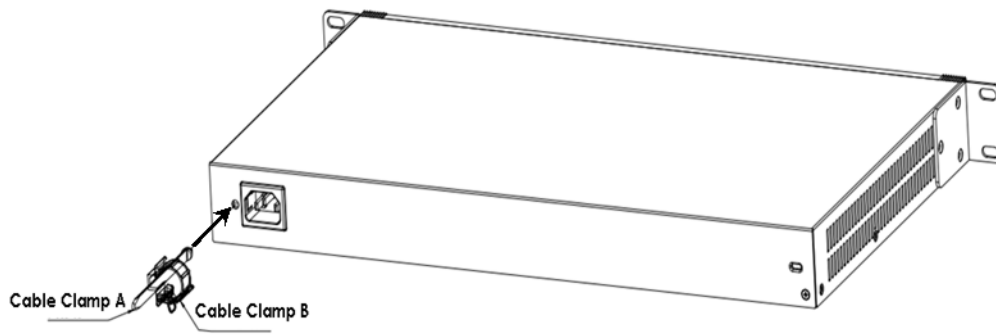

- 2 Connect the power cord to the Zyxel Device power socket.
- 3 Open **Cable Clamp B** and attach it to the power cord. Make sure **Cable Clamp B** covers the head of the power cord.

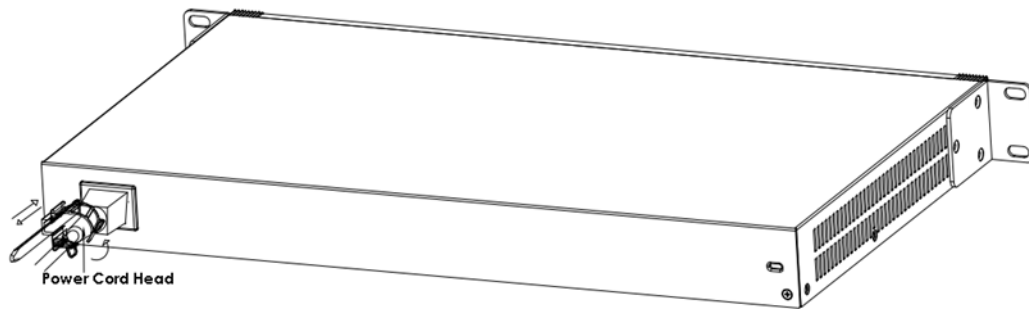

- 4 Close **Cable Clamp B** to secure the power cord to the power socket.

CHAPTER 4

Dashboard

4.1 Overview

Use the **Dashboard** screens to check status information about the Zyxel Device.

4.1.1 What You Can Do in this Chapter

Use the main **Dashboard** screen to see the Zyxel Device's general device information, system status, and system resource usage. You can also display other status screens for more information.

Use the **Dashboard** screens to view the following.

- [System Information Screen on page 64](#)
- [Port Status Screen on page 67](#)
- [Resource Usage Screen on page 68](#)
- [Bandwidth on page 69](#)
- [Client Usage Screen on page 70](#)
- [The Latest Logs Screen on page 70](#)
- [The Security Screen on page 71](#)

4.2 The System Screen

The **System** screen displays when you log into the Zyxel Device or click **System** in the navigation panel. The **System** screen displays general device information, system resource usage, and interface status in widgets that you can re-arrange to suit your needs. You can also click the refresh icon () to refresh individual widgets.

Figure 55 Dashboard > System



4.2.1 System Information Screen

The **System Information** screen displays Zyxel Device's system and model name, serial number, MAC address and firmware version shown in the below screen.

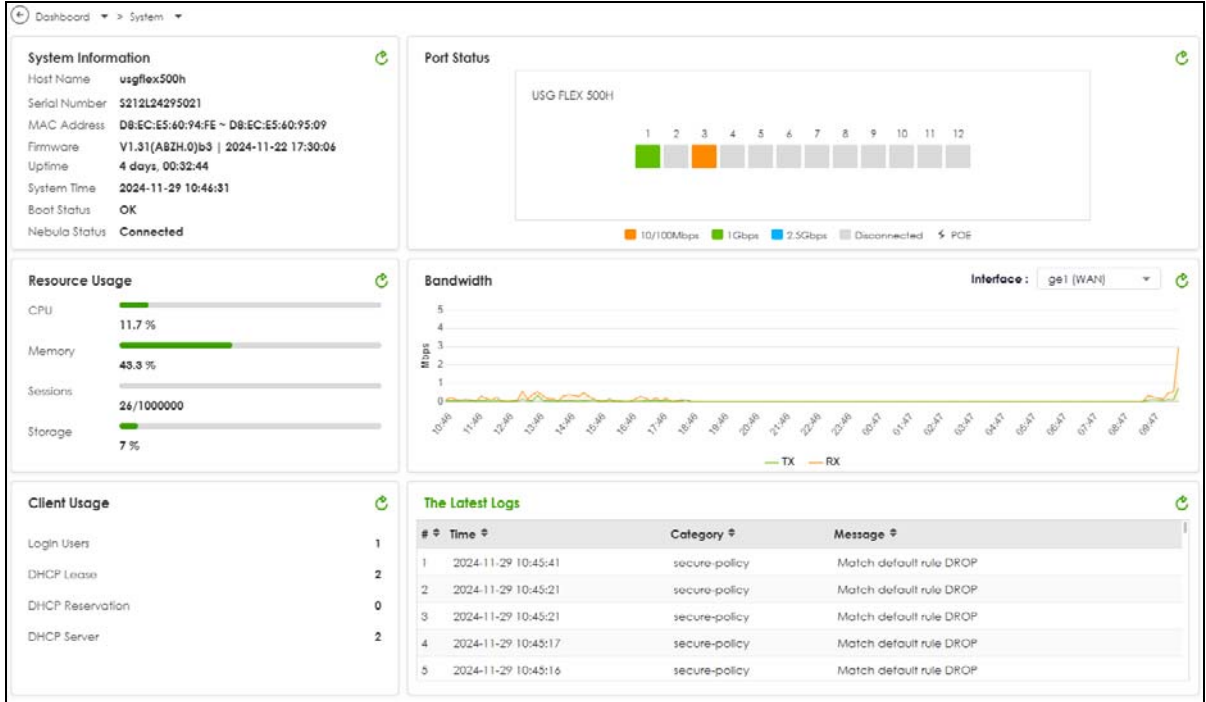
Figure 56 Dashboard > System > System Information

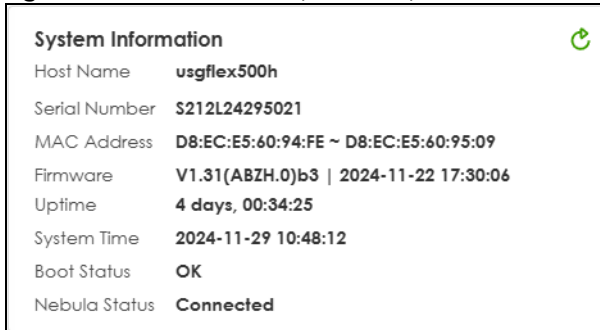

The table describes the fields in this screen.

Table 22 Dashboard > System > System Information

LABEL	DESCRIPTION
Host Name	This field displays the name used to identify the Zyxel Device on any network. Click the link and open the Host Name screen where you can edit and make changes to the system and domain name.
Serial Number	This field displays the serial number of this Zyxel Device. The serial number is used for device tracking and control.
MAC Address	This field displays the MAC addresses used by the Zyxel Device. Each physical port has one MAC address. The first MAC address is assigned to physical port 1, the second MAC address is assigned to physical port 2, and so on.

Table 22 Dashboard > System > System Information

LABEL	DESCRIPTION
Firmware	This field displays the version number and date of the firmware the Zyxel Device is currently running. Click the link to open the File Manager screen where you can upload firmware.
Uptime	This field displays how long the Zyxel Device has been running since it last restarted or was turned on.
System Time	This field displays the current date and time in the Zyxel Device. The format is yyyy-mm-dd hh:mm:ss.

Table 22 Dashboard > System > System Information

LABEL	DESCRIPTION
Boot Status	<p>This field displays details about the Zyxel Device's startup state.</p> <p>OK - Boot success: The Zyxel Device has started up successfully.</p> <p>OK - Firmware update at yyyy/mm/dd hh:mm: This displays the date and time when the Zyxel Device last updated the firmware successfully.</p> <p>OK - Factory default at yyyy/mm/dd hh:mm: This displays the date and time when the Zyxel Device was last reset to the factory default settings and rebooted successfully.</p> <p>OK - User reboot at yyyy/mm/dd hh:mm: This displays the date and time when the Zyxel Device last rebooted successfully.</p> <p>OK - Reset default configuration at yyyy/mm/dd hh:mm: This occurs when the Zyxel Device starts for the first time or you reset the Zyxel Device to the factory default settings.</p> <p>OK - System recovery at yyyy/mm/dd hh:mm: This displays the date and time when the Zyxel Device last underwent system recovery and rebooted successfully.</p> <p>OK - Apply configuration xxxx.conf at yyyy/mm/dd hh:mm: This displays the date and time when the Zyxel Device last applied the configuration file and rebooted successfully.</p> <p>OK - Switch to (1st 2nd) partition at yyyy/mm/dd hh:mm: This displays the date and time when the Zyxel Device last rebooted using firmware in the backup partition.</p> <p>OK - Reset admin password at yyyy/mm/dd hh:mm: This displays the date and time when the Zyxel Device reset the admin password using the "atkz-g" command and rebooted successfully.</p> <p>WARN - Fallback to lastgood configuration: The Zyxel Device was unable to apply the startup-config.conf configuration file and fell back to the lastgood.conf configuration file. See Section 28.1.3 on page 483 for more information on configuration file flow at restart.</p> <p>WARN - Fallback to lastgood configuration after firmware update at yyyy/mm/dd hh:mm: This displays the date and time when the Zyxel Device was last unable to apply the startup-config.conf configuration file after firmware update and fell back to the lastgood.conf configuration file. See Section 28.1.3 on page 483 for more information on configuration file flow at restart.</p> <p>ERROR - Fallback to system default configuration: The Zyxel Device was unable to apply the lastgood.conf configuration file and fell back to the system default configuration file (system-default.conf). See Section 28.1.3 on page 483 for more information on configuration file flow at restart.</p> <p>ERROR - Fallback to system default configuration after firmware update at yyyy/mm/dd hh:mm: This displays the date and time when the Zyxel Device was unable to apply the lastgood.conf configuration file after the firmware update and fell back to the system default configuration file (system-default.conf). See Section 28.1.3 on page 483 for more information on configuration file flow at restart.</p>

Table 22 Dashboard > System > System Information

LABEL	DESCRIPTION
Nebula Status	<p>The field displays the connection status between the Zyxel Device and the Nebula Control Center (NCC).</p> <p>Connected - The Zyxel Device has an Internet connection with the NCC.</p> <p>Disconnected - The Zyxel Device does not have an Internet connection with the NCC.</p> <p>Unknown - The Zyxel Device was unable to receive a timely response from the Nebula server when checking the Internet connection with the NCC. Go to Maintenance > Diagnostics > Network Tool, select Nebula Status, and click Test to verify if the Zyxel Device can properly connect to the NCC over the Internet.</p> <p>No Site Assignment - The Zyxel Device is registered with the NCC, but is not assigned to a site.</p> <p>Disabled - The Internet connection from the Zyxel Device to the NCC was disabled using the Command Line Interface (CLI).</p> <p>Note: To transfer your Zyxel Device management to the NCC, first make sure your Zyxel Device is connected to the Internet.</p>

4.2.2 Port Status Screen

The **Port Status** screen displays Zyxel Device's ports and connections status.

Figure 57 Dashboard > System > Port Status

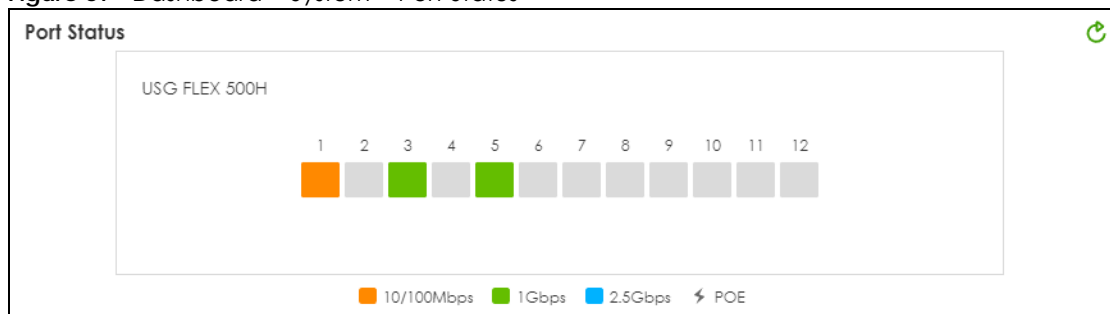

The following table describes the labels in this screen.

Table 23 Dashboard > System > Port Status

LABEL	DESCRIPTION
Port Status	<p>This field displays details about the status of the Zyxel Device's ports and connections. An unconnected interface or slot appears grayed out. Hover your cursor over a connected interface or slot to display status details.</p>

The following labels display when you hover your cursor over a connected interface or slot.

Table 23 Dashboard > System (continued)> Port Status

LABEL	DESCRIPTION
Name	This field displays the name of each interface.
Status	This field displays the current status of each interface or device installed in a slot. The possible values depend on what type of interface it is. Inactive - The Ethernet interface is disabled. Down - The Ethernet interface does not have any physical ports associated with it or the Ethernet interface is enabled but not connected. Speed / Duplex - The Ethernet interface is enabled and connected. This field displays the port speed and duplex setting (Full or Half).
Interface	This field displays the zone to which the interface is currently assigned.
IP Address/ Mask	This field displays the current IP address and subnet mask assigned to the interface. If the interface is a member of an active virtual router, this field displays the IP address it is currently using. This is either the static IP address of the interface (if it is the master) or the management IP address (if it is a backup).
Power Reset	Click Power Reset to power off the PD (powered device) connected to the port, by temporarily disabling then re-enabling PoE. This button only appears when the PoE port is connected to a PD.

4.2.3 Resource Usage Screen

Click the bar to see a graphic on that resource.

Figure 58 Dashboard > System > Resource Usage

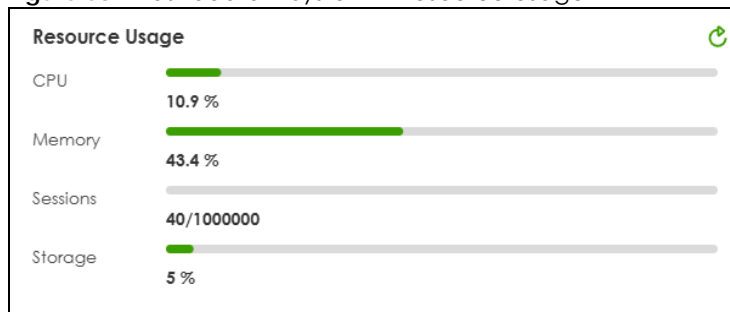

The table describes the fields in the screen.

Table 24 Dashboard > System > Resource Usage

LABEL	DESCRIPTION
CPU	This field displays what percentage of the Zyxel Device's processing capability is currently being used. It is an average of all core usage. Click this field to display a chart of the Zyxel Device's recent CPU usage for each core within a specified time period. CPU usage may appear temporarily high when creating graphic-intensive statistics and reports. You may ignore it, and observe the long-term usage.
Memory	This field displays what percentage of the Zyxel Device's RAM is currently being used. Click this field to display a chart of the Zyxel Device's recent total, system and fastpath memory usage.

Table 24 Dashboard > System > Resource Usage

LABEL	DESCRIPTION
Sessions	This field shows how many sessions, established and non-established, that pass through/from/to/within the Zyxel Device. Click this field to display a chart of Zyxel Device's session usage within a specified time period.
Storage	This field displays the percentage of the USB storage device connected to the Zyxel Device is currently being used. Click this field to display more information about the USB storage device. See Section 4.2.3.1 on page 69 for more details.

4.2.3.1 USB Storage

The **USB Storage** screen displays information of the USB storage device connected to the Zyxel Device.

Figure 59 Dashboard > System > Resource Usage > Storage

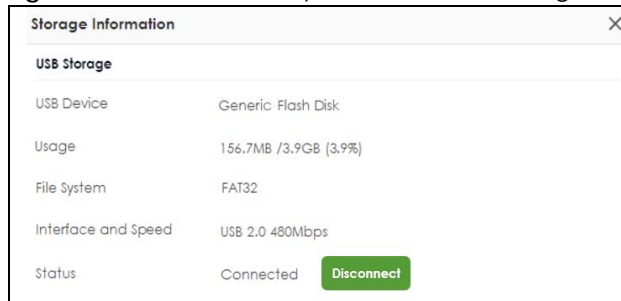

The table describes the fields in the screen.

Table 25 Dashboard > System > Resource Usage > Storage

LABEL	DESCRIPTION
USB Device	This field displays the name of the USB storage device.
Usage	This field displays the used space (in MB or GB), available space (in MB or GB), and the percentage of used space on the USB storage device.
File System	This field displays what file system the USB storage device is formatted with. The supported formats for the Zyxel Device are FAT16, FAT32, EXT3, and EXT4. See the troubleshooting My USB storage device is not compatible with the Zyxel Device , for how to change the format of your USB storage device.
Interface and Speed	This field displays the USB standard and the connection speed the USB storage device supports.
Status	<p>This field displays the connecting status of the USB storage device.</p> <ul style="list-style-type: none"> • Connected - you can have the Zyxel Device use the USB storage device. • Connecting - the Zyxel Device is mounting the USB storage device. • Disconnected - the connected USB storage device was manually unmounted by using the Disconnect button or for some reason the Zyxel Device cannot mount it. <p>Click the Disconnect button to stop the Zyxel Device from using the USB storage device. If you disconnect the USB storage device from the Zyxel Device, you can then use click Connect to reconnect the USB storage device.</p>

4.2.4 Bandwidth

This screen displays a line graph of packet statistics for each interface.

Figure 60 Dashboard > System > Bandwidth

This table describes the fields in the above screen.

Table 26 Dashboard > Tx/Rx Statistics

LABEL	DESCRIPTION
Mbps	The y-axis represents the speed of transmission or reception.
Time	The x-axis shows the time period over which the transmission or reception occurred.

4.2.5 Client Usage Screen

This screen displays the number of users logged into the Zyxel Device and a summary of the DHCP settings status. Click the links to go to the **Login Users** or the **DHCP Table** screen.

Figure 61 Dashboard > System > Client Usage

Client Usage	
Login Users	3
DHCP Lease	1
DHCP Reservation	0
DHCP Server	2

This table describes the fields in the above screen.

Table 27 Dashboard > System > Client Usage

LABEL	DESCRIPTION
Login Users	This field displays the number of users that are currently logged into the Zyxel Device.
DHCP Lease	This field displays the number of IP addresses that are leased for clients.
Reservation	This field displays the number of IP addresses that are reserved for the MAC addresses.
DHCP Server	This field displays the number of interface that the DHCP server is enabled on the Zyxel Device.

4.2.6 The Latest Logs Screen

In this screen click **The Latest Logs** to go to **Log & Report > Log / Events**.

Figure 62 Dashboard > System > The Latest Logs

The Latest Logs			
#	Time	Category	Message
1	2024-02-23 11:43:41	secure-policy	Match default rule DROP
2	2024-02-23 11:43:40	secure-policy	Match default rule DROP
3	2024-02-23 11:43:39	secure-policy	Match default rule DROP
4	2024-02-23 11:43:22	secure-policy	Match default rule DROP
5	2024-02-23 11:43:22	secure-policy	Match default rule DROP

The table describes the fields in the screen.

Table 28 Dashboard > System > The Latest Log

LABEL	DESCRIPTION
#	This is the entry's rank in the list of alert logs.
Time	This field displays the date and time the log was created.
Category	This field displays the type of log generated.
Message	This field displays the actual log message.
Source	This field displays the source address (if any) in the packet that generated the log.
Destination	This field displays the destination address (if any) in the packet that generated the log.
Priority	This field displays the severity of the log.

4.3 The Security Screen

Use the **Security** screen to check security status information about the Zyxel Device. If a license has expired, you will see a reminder in this screen. You need to renew the license in order to keep using the feature. Click **Buy Now** to go to Marketplace to purchase a new license. Click **See Details** to go to the Zyxel web page to find more information on licenses for your Zyxel Device.

Figure 63 Dashboard > Security

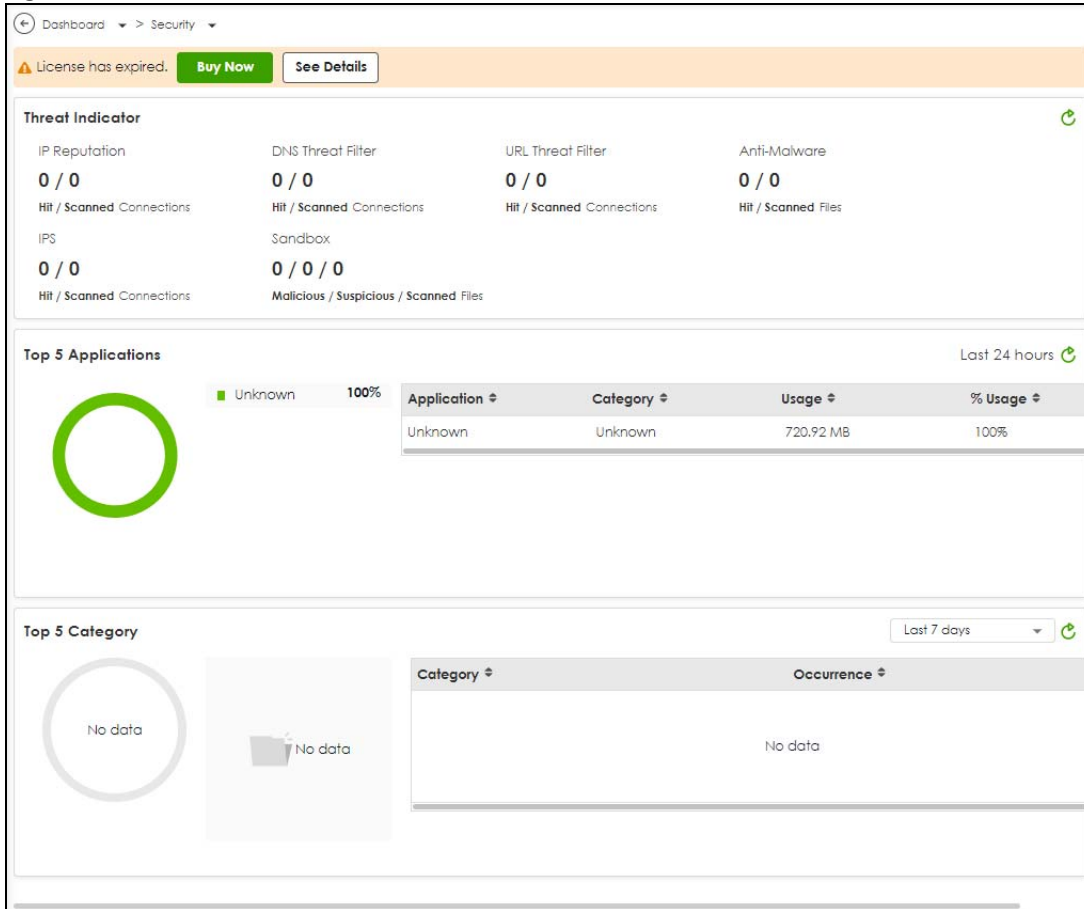

This screen gives the following information:

- The amount of scanned traffic
- The number of scanned connections for URL threat filtering
- The number of scanned files for anti-malware
- The number of scanned connections for IPS
- The number of scanned files for sandbox.
- Top 5 applications that are used the most
- Top 5 Categories that are detected the most

Click the **Refresh** icon to update the information in the window right away.

PART II

Technical Reference

CHAPTER 5

Monitor

5.1 Overview

Use the **Monitor** screens to check status and statistics information.

5.1.1 What You Can Do in this Chapter

Use the **Monitor** screens for the following.

- Use the **Traffic Statistics > Application Usage** ([Section 5.2 on page 75](#)) screen to view application statistics.
- Use the **Traffic Statistics > Port** ([Section 5.3 on page 77](#)) screen to view the packets statistics for each port selected for monitoring.
- Use the **Traffic Statistics > Interface** ([Section 5.4 on page 78](#)) screen to view the packets statistics for each interface selected for monitoring.
- Use the **Traffic Statistics > Session Monitor** screen (see [Section 5.5 on page 78](#)) to view sessions by user or service.
- Use the **Security Statistics > Content Filter** screen ([Section 5.6 on page 80](#)) to start or stop data collection and view content filter statistics.
- Use the **Security Statistics > Reputation Filter** screens ([Section 5.7 on page 82](#)) to view statistics of IP reputation, DNS threat filtering and URL threat filtering.
- Use the **Security Statistics > IPS** screen ([Section 5.8 on page 86](#)) to start or stop data collection and view IPS statistics.
- Use the **Security Statistics > Anti-Malware** ([Section 5.9 on page 87](#)) screen to view anti-malware statistics.
- Use the **Security Statistics > Sandbox** screen ([Section 5.10 on page 89](#)) to view sandbox statistics.
- Use the **Security Statistics > SSL Inspection** screen ([Section 5.11 on page 90](#)) to see a report on SSL Inspection and a certificate cache list.
- Use the **Network Status > Interface** screen (see [Section 5.5 on page 78](#)) to view the interface packets statistics.
- Use the **Network Status > Device Insight** screen (see [Section 5.13 on page 94](#)) to view the status of the clients connected to the Zyxel Device.
- Use the **Network Status > Login Users** screen ([Section 5.14 on page 97](#)) to look at a list of the users currently logged into the Zyxel Device.
- Use the **Network Status > DHCP Table** screen (see [Section 5.16 on page 99](#)) to view a list of interfaces and their DHCP-assigned IP addresses.
- Use the **VPN Status > IPSec VPN > Site to Site VPN** screen ([Section 5.17.1 on page 101](#)) to display and manage active IPSec SAs.
- Use the **VPN Status > IPSec VPN > Remote Access VPN** screen ([Section 5.17.2 on page 102](#)) to display and manage remote access VPN clients.

- Use the **VPN Status > SSL VPN > Remote Access VPN** screen (Section 5.18 on page 103) to list the users currently logged into the SSL VPN client portal. You can also log out individual users and delete related session information.

5.2 The Application Usage Screen

This screen provides a convenient way to monitor the use of various applications by hosts in the network.

If a license has expired, you will see a reminder in this screen. You need to renew the license in order to keep using the feature. Click **Buy Now** to go to Marketplace to purchase a new license. Click **See Details** to go to the Zyxel web page to find more information on licenses for your Zyxel Device.

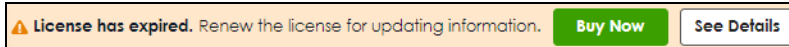

Click **Traffic Statistics > Application Usage** to display the following screen. This screen displays usage by application type or the IP addresses of hosts in your network.

Figure 64 Traffic Statistics > Usage by Application

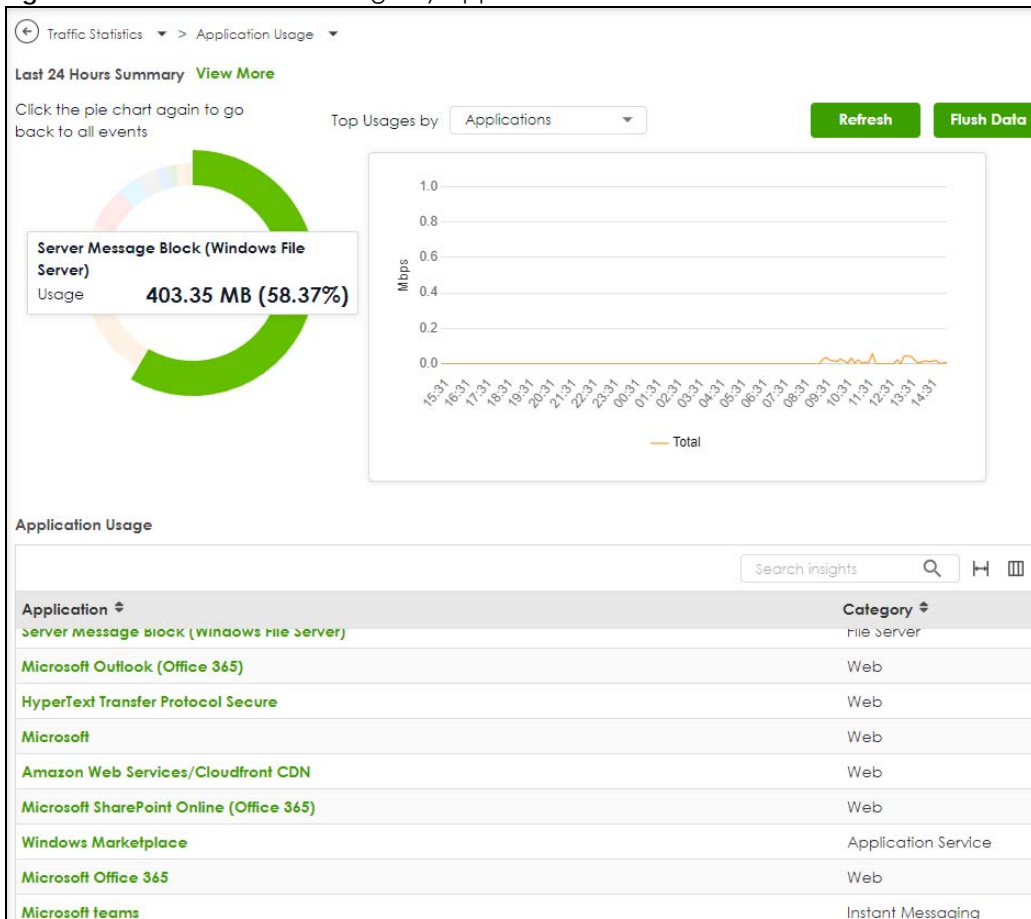
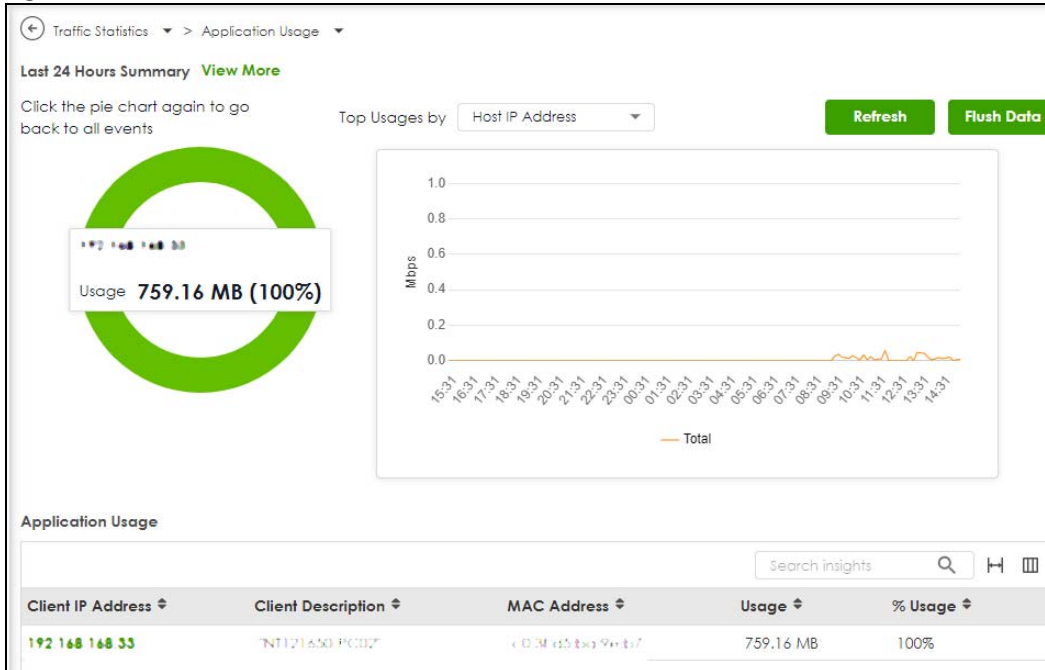

Figure 65 Traffic Statistics > Usage by Host IP



The following table describes the labels in this screen.

Table 29 Traffic Statistics > Application Usage

LABEL	DESCRIPTION
Last 24 Hours Summary	If you want to view more data than the past 24 hours in SecuReporter, click View More . You should already have a SecuReporter account.
Pie Chart	Click an item in the pie chart for more detailed information.
Refresh	Click this button to update the report display.
Flush Data	Click this button to discard all of the screen's statistics for inactive sessions. Flushing data only removes traffic logs from ended sessions. Active sessions remain unaffected. Click Refresh to update the report display.
Top Usage by	Select to display usage by application or host IP address.
Application	If you selected by application, then this is the name of the application identified.
Category	This is the category the application belongs to.
Usage	This is how much traffic the application has used.
%Usage	This is the percentage of traffic the application has used.
Client IP address	If you selected by host IP address, then this is the IP address of the host identified.
Client Description	This is the name of the host identified.
MAC Address	This is the MAC address of the host device.
Usage	This is how much traffic the host has used.
%Usage	This is the percentage of traffic the host has used.

5.3 The Port Statistics Screen

Use this screen to look at packets statistics for each Gigabit Ethernet port. Ports are physical ports to which you connect cables.

To access this screen, click **Traffic Statistics > Port**.

Figure 66 Traffic Statistics > Port

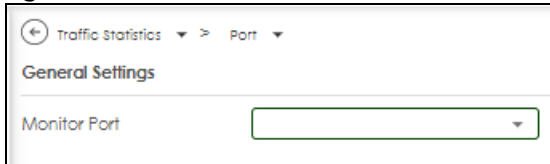

Select a port to monitor.

Figure 67 Traffic Statistics > Port

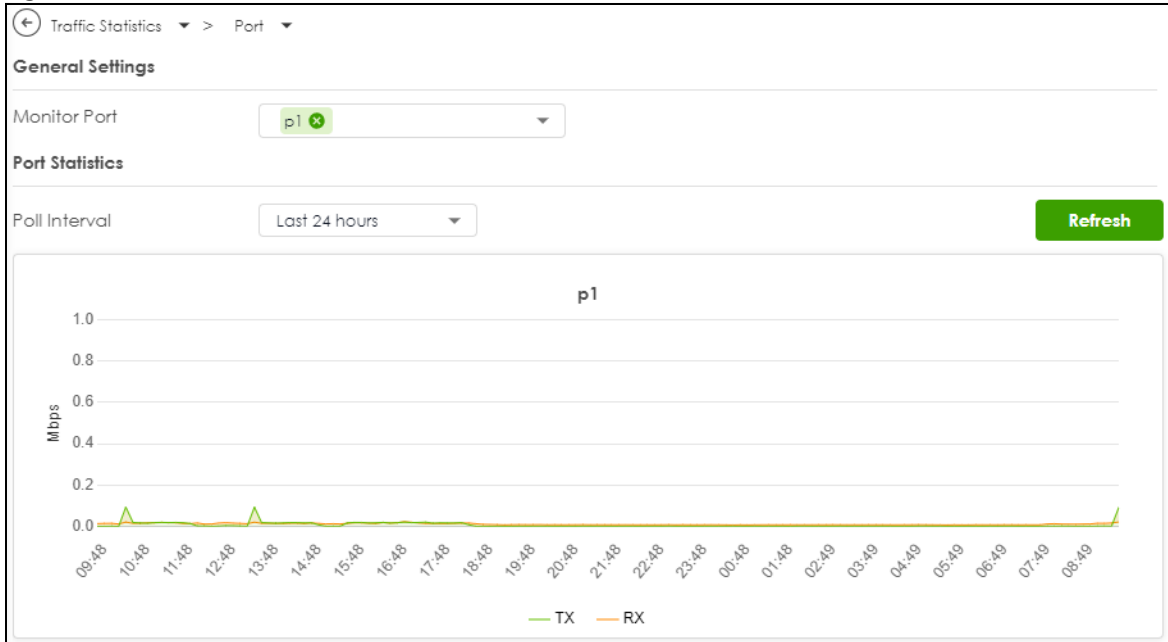

The following table describes the labels in this screen.

Table 30 System Statistics > Port

LABEL	DESCRIPTION
Monitor Port	Select a port from the drop-down list box to view the port packets statistics.
Poll Interval	Enter how often you want this window to be updated automatically, and click Refresh .
TX	This line represents traffic transmitted from the Zyxel Device on the selected physical port since it was last connected. Click TX to show or hide the TX line in the chart.
RX	This line represents the traffic received by the Zyxel Device on the selected physical port since it was last connected. Click RX to show or hide the RX line in the chart.

5.4 The Interface Statistics Screen

Use this screen to look at packets statistics for each interface. Interfaces are used within the system operationally. You use them in configuring various features.

To access this screen, click **Traffic Statistics > Interface**.

Figure 68 Traffic Statistics > Port

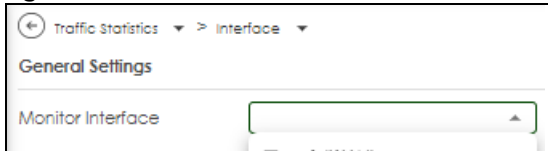

Select an interface to monitor.

Figure 69 Traffic Statistics > Interface

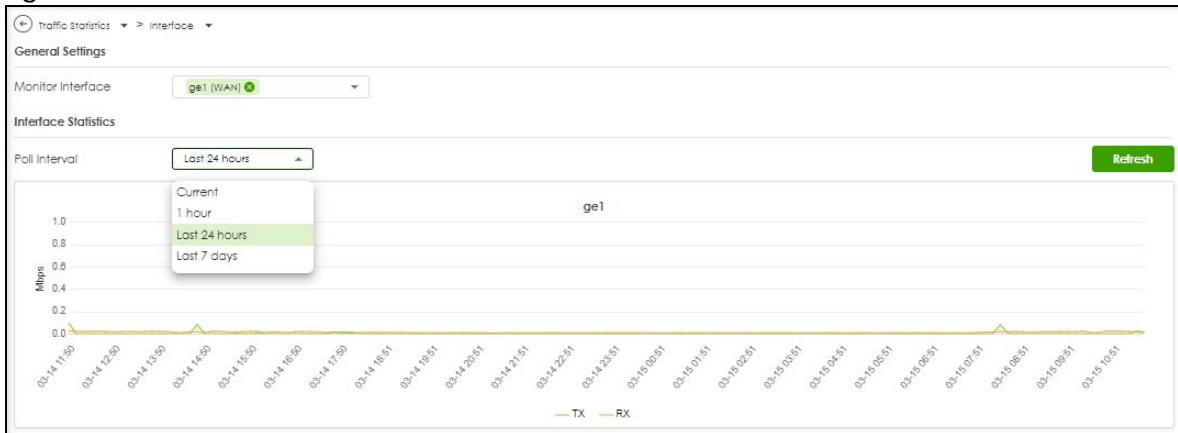

The following table describes the labels in this screen.

Table 31 Traffic Statistics > Interface

LABEL	DESCRIPTION
Monitor Interface	Select an interface from the drop-down list box to view the interface packets statistics.
Poll Interval	Enter how often you want this window to be updated automatically, and click Refresh .
TX	This line displays the transmission speed, in bytes per second, on the interface in the one-second interval before the screen updated.
RX	This line displays the reception speed, in bytes per second, on the interface in the one-second interval before the screen updated.

5.5 The Session Monitor Screen

The **Session Monitor** screen displays all established sessions that pass through the Zyxel Device for debugging or statistical analysis. It is not possible to manage sessions in this screen. The following information is displayed.

- User who started the session
- Protocol or service port used
- Source address
- Destination address
- Number of bytes received (so far)
- Number of bytes transmitted (so far)
- Duration (so far)

You can look at all established sessions that passed through the Zyxel Device by user, service, source IP address, or destination IP address. You can also filter the information by user, protocol / service or service group, source address, and/or destination address and view it by user.

Click **Traffic Statistics > Session Monitor** to display the following screen.

Figure 70 Traffic Statistics > Session Monitor

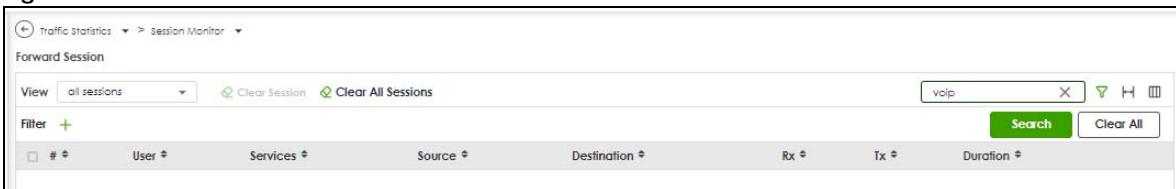

The following table describes the labels in this screen.

Table 32 Traffic Statistics > Session Monitor

LABEL	DESCRIPTION
View	Select how you want the established sessions that passed through the Zyxel Device to be displayed. Choices are: <ul style="list-style-type: none"> • sessions by user - display all active sessions grouped by user • sessions by services - display all active sessions grouped by service or protocol • sessions by source IP - display all active sessions grouped by source IP address • sessions by source region - display all active sessions grouped by source IP address • sessions by destination IP - display all active sessions grouped by destination IP address • sessions by destination region - display all active sessions grouped by destination IP address • all sessions - filter the active sessions by the User, Service, Source IP, and Destination IP, and display each session individually (sorted by user).
Clear Session	Select a session, then click this button to remove the selected session.
Clear All Sessions	Click this button to remove all sessions.
Refresh	Click this button to update the information on the screen. The screen also refreshes automatically when you open and close the screen.
Search	Type an item in the search box, then click this to display all sessions in the table below according to the item you typed.
Clear All	Click this to remove all items found in the search.
Filter	Click the Filter icon  , click + to display Add Filter , pick a filter, then click Search to display specific sessions according to the filter selected. You may select multiple filters, but just one of each type, configured one at a time. <div data-bbox="488 1703 716 1885" style="border: 1px solid black; padding: 5px; margin-top: 10px;"> <p>Add Filter</p> <p>User</p> <p>Service</p> <p>Source Address</p> <p>Destination Address</p> <p>Source Country</p> <p>Destination Country</p> </div>

Table 32 Traffic Statistics > Session Monitor (continued)

LABEL	DESCRIPTION
	The User , Service , Source Address , Destination Address , Source Country and Destination Country fields display if you view all sessions.
#	This field is the rank of each record. The names are sorted by the name of user in active session. You can use the pull down menu on the right to choose sorting method.
User	This field displays the user in each active session. If you are looking at the sessions by users (or all sessions) report, click + or - to display or hide details about a user's sessions.
Services	This field displays the protocol used in each active session. If you are looking at the sessions by services report, click + or - to display or hide details about a protocol's sessions.
Source	This field displays the source IP address and port in each active session. If you are looking at the sessions by source IP report, click + or - to display or hide details about a source IP address's sessions.
Destination	This field displays the destination IP address and port in each active session. If you are looking at the sessions by destination IP report, click + or - to display or hide details about a destination IP address's sessions.
Rx	This field displays the amount of information received by the source in the active session.
Tx	This field displays the amount of information transmitted by the source in the active session.
Duration	This field displays the length of the active session in hours, minutes, seconds format.

5.6 The Content Filter Screen

Click **Security Statistics > Content Filter** to display the following screens. The Zyxel Device content filtering includes HTTP(S) traffic scan and DNS domain scan. The HTTP(S) traffic scan allows the Zyxel Device to block access to specific websites, by inspecting the URL or Server Name Indication (SNI) that the user's web browser sends to the web server. The DNS domain scan allows the Zyxel Device to block access to specific websites by inspecting DNS queries made by users on your network. If the website in the DNS query contains prohibited material, then the Zyxel Device replies to the DNS query with a IP address that points to the block page.

If a license has expired, you will see a reminder in this screen. You need to renew the license in order to keep using the feature. Click **Buy Now** to go to Marketplace to purchase a new license. Click **See Details** to go to the Zyxel web page to find more information on licenses for your Zyxel Device.

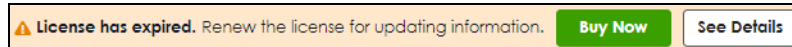

These screens display some basic statistics on HTTP(S) traffic scan and DNS domain scan.

Figure 71 Security Statistics > Content Filter

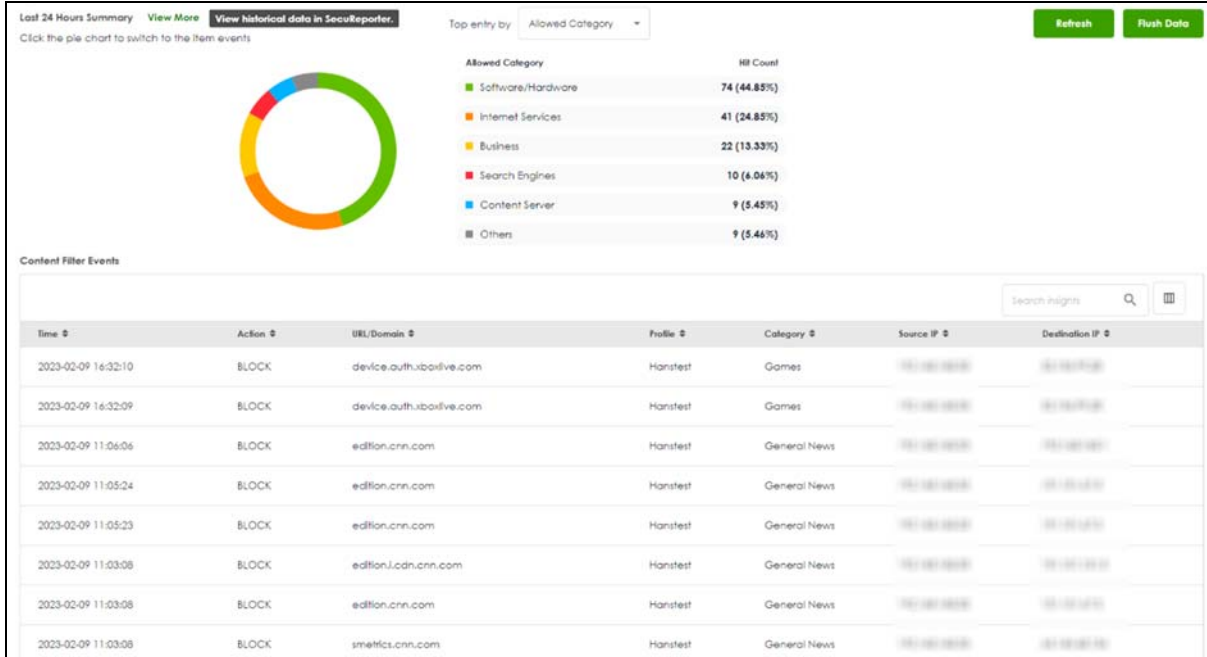

The following table describes the labels in this screen.

Table 33 Security Statistics > Content Filter

LABEL	DESCRIPTION
Last 24 Hours Summary	If you want to view more data than the past 24 hours in SecuReporter, click View More . You should already have a SecuReporter account.
Pie Chart	Click an item in the pie chart for more detailed information.
Top entry by	Use this field to have the following (read-only) table display the top content filter log entries by Blocked Category , Blocked Source IP , Blocked URL , Allowed Category , Allowed Source IP , or Allowed URL . This table displays the most common, recent content filter logs. See the log screen for less common content filter logs or use a syslog server to record all content filter logs. Select Blocked Category to list the web site categories the Zyxel Device has blocked. Select Blocked Source IP to list the source IP addresses of the web sites the Zyxel Device has blocked. Select Blocked URL to list the URLs of the web sites the Zyxel Device has blocked. Select Allowed Category to list the web site categories the Zyxel Device has allowed. Select Allowed Source IP to list the source IP addresses of the web sites the Zyxel Device has allowed. Select Allowed URL to list the URLs of the web sites the Zyxel Device has allowed.
Refresh	Click this button to update the report display.
Flush Data	Click this button to discard all of the screen's statistics. Click Refresh to update the report display.
Time	This column displays the date and time when the users access the URL or FQDN.
Action	This column displays whether the Zyxel Device blocks or passes the accessed URL or FQDN.
URL/Domain	This column displays the URL or domain name of the web site accessed.
Profile	This column displays the content filter profile the website belongs to.

Table 33 Security Statistics > Content Filter

LABEL	DESCRIPTION
Category	This column displays the category the accessed web site belongs to.
Source IP	This column displays the source IP address of the web site the Zyxel Device has checked.
Destination IP	This column displays the destination IP address at which the traffic of the web site the Zyxel Device has checked is sent.

5.7 The Reputation Filter Screens

Click **Security Statistics > Reputation Filter** to display the following screens. These screens display reputation filter statistics.

The Zyxel Device reputation filter includes IP reputation, DNS threat filter and URL threat filter.

If a license has expired, you will see a reminder in this screen. You need to renew the license in order to keep using the feature. Click **Buy Now** to go to Marketplace to purchase a new license. Click **See Details** to go to the Zyxel web page to find more information on licenses for your Zyxel Device.

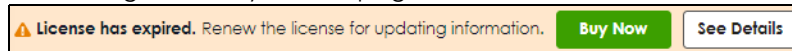

5.7.1 IP Reputation

This screen displays IP reputation statistics. IP reputation checks the reputation of an IP address from a database.

Figure 72 Security Statistics > Reputation Filter > IP Reputation

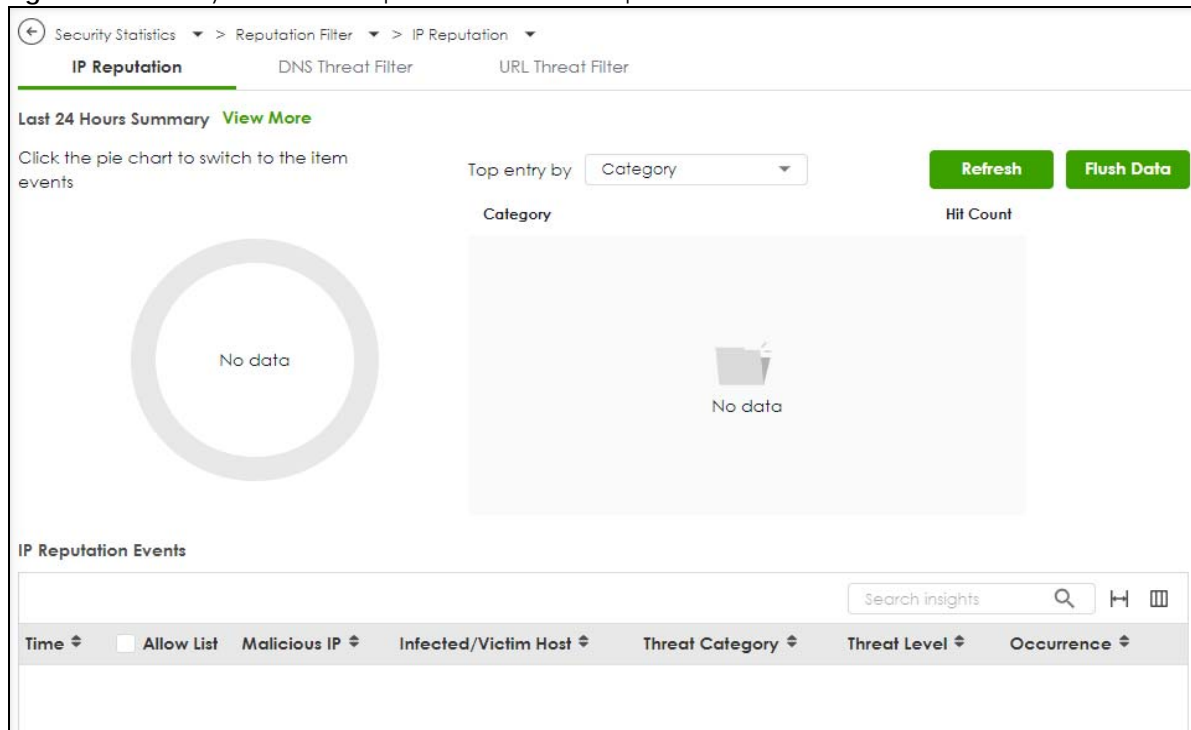

The following table describes the labels in this screen.

Table 34 Security Statistics > Reputation Filter > IP Reputation

LABEL	DESCRIPTION
Last 24 Hours Summary	If you want to view more data than the past 24 hours in SecuReporter, click View More . You should already have a SecuReporter account.
Pie Chart	Click an item in the pie chart for more detailed information.
Top Entries By	Use this field to have the following (read-only) table display the top IP reputation log entries by Category , Infected/Victim Host or Malicious IP . This table displays the most common, recent IP reputation logs. See the log screen for less common IP reputation logs or use a syslog server to record all IP reputation logs. Select Category to list the most common categories of packets that the Zyxel Device has detected. Select Infected/Victim Host to list the most common IP addresses of the infected hosts. Select Malicious IP to list the most common IPv4 addresses with bad reputation that have sent packets to the Zyxel Device.
Refresh	Click this button to update the report display.
Flush Data	Click this button to discard all of the screen's statistics. Click Refresh to update the report display.
IP Reputation Events	
Time	This field displays the date and time the entry was created.
+ Allow List	Select an entry and click this to add it to the IP reputation allow list.
Malicious IP	This field displays the IPv4 address with bad reputation.
Infected/Victim Host	This field displays the IP address of the infected host.
Threat Category	This field displays the category of the entry.
Threat Level	This field displays the threat level of the entry.
Occurrence	This field displays how many times the Zyxel Device has detected the event described in the entry.

5.7.2 DNS Threat Filter

This screen displays DNS threat filter statistics. DNS threat filtering inspects DNS queries made by clients on your network and compares the queries against a database of blocked or allowed Fully Qualified Domain Names (FQDNs).

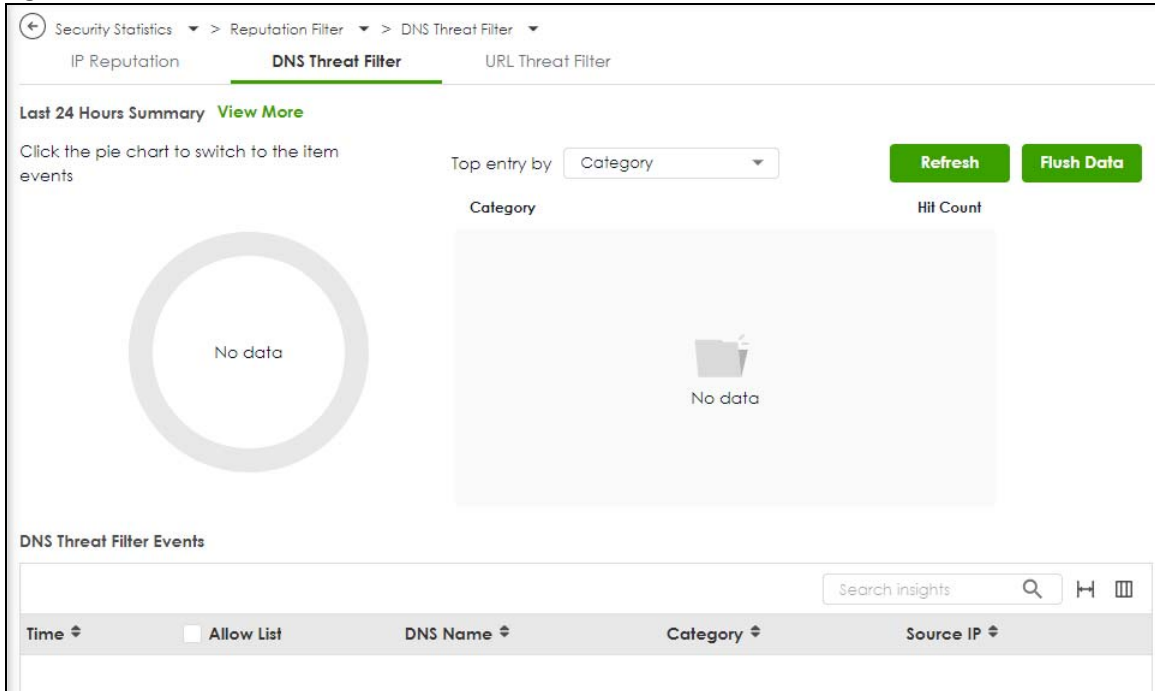
Figure 73 Security Statistics > Reputation Filter > DNS Threat Filter

The following table describes the labels in this screen.

Table 35 Security Statistics > Reputation Filter > DNS Threat Filter

LABEL	DESCRIPTION
Last 24 Hours Summary	If you want to view more data than the past 24 hours in SecuReporter, click View More . You should already have a SecuReporter account.
Pie Chart	Click an item in the pie chart for more detailed information.
Top Entries By	Use this field to have the following (read-only) table display the top DNS threat filter log entries by Category , Source IP or DNS Name . This table displays the most common, recent DNS threat filter logs. See the log screen for less common DNS threat filter logs or use a syslog server to record all DNS threat filter logs. Select Category to list the most common categories of packets that the Zyxel Device has detected. Select Source IP to list the most common source IP addresses of traffic. Select DNS Name to list the most common FQDNs of the infected websites.
Refresh	Click this button to update the report display.
Flush Data	Click this button to discard all of the screen's statistics. Click Refresh to update the report display.
DNS Threat Filter Events	
Time	This field displays the date and time the entry was created.
+ Allow List	Select an entry and click this to add it to the DNS filtering allow list.
DNS Name	This field displays the FQDN of an infected website.
Category	This field displays the category of the entry.
Source IP	This field displays the source IP address of traffic that you want to trace.

5.7.3 URL Threat Filter

This screen displays URL threat filter statistics. URL threat filtering compares access to specific URLs against a database of blocked or allowed sites.

Figure 74 Security Statistics > Reputation Filter > URL Threat Filter

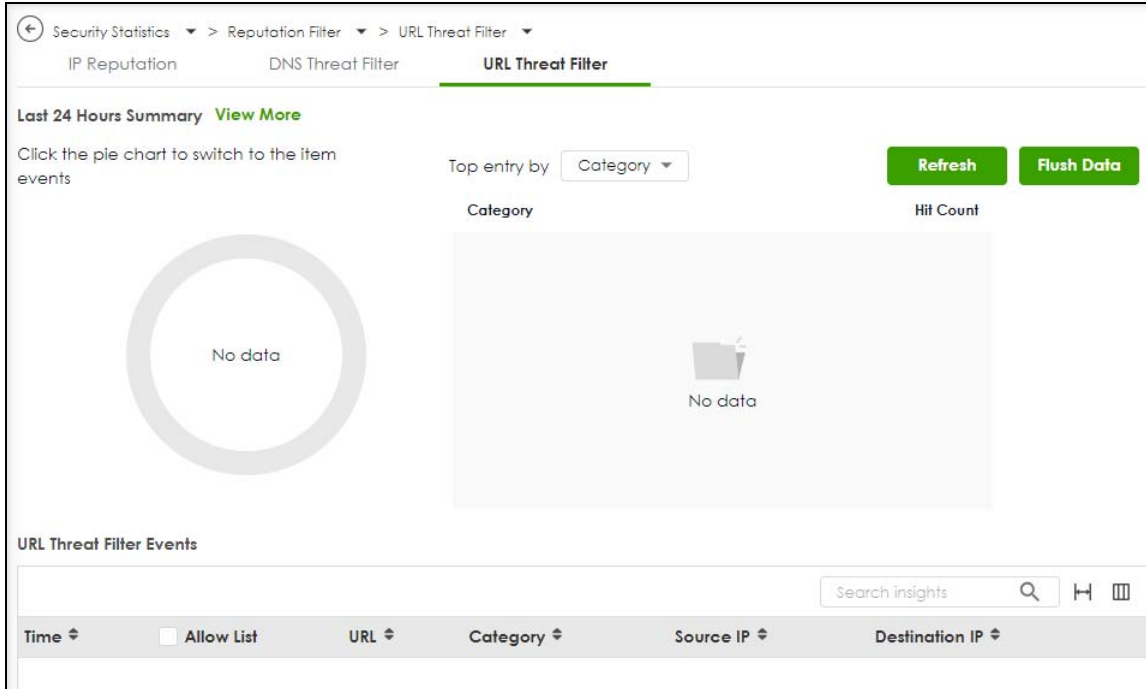

The following table describes the labels in this screen.

Table 36 Security Statistics > Reputation Filter > URL Threat Filter

LABEL	DESCRIPTION
Last 24 Hours Summary	If you want to view more data than the past 24 hours in SecuReporter, click View More . You should already have a SecuReporter account.
Pie Chart	Click an item in the pie chart for more detailed information.
Top Entries By	Use this field to have the following (read-only) table display the top URL threat filter log entries by Category , URL or Source IP . This table displays the most common, recent URL threat filter logs. See the log screen for less common URL threat filter logs or use a syslog server to record all URL threat filter logs. Select Category to list the most common categories of packets that the Zyxel Device has detected. Select URL to list the most common URLs of the infected websites. Select Source IP to list the most common source IP addresses of traffic.
Refresh	Click this button to update the report display.
Flush Data	Click this button to discard all of the screen's statistics. Click Refresh to update the report display.
URL Threat Filter Events	
Time	This field displays the date and time the entry was created.
+ Allow List	Select an entry and click this to add it to the URL Threat filtering allow list.
URL	This field displays the URL of an infected website.

Table 36 Security Statistics > Reputation Filter > URL Threat Filter

LABEL	DESCRIPTION
Category	This field displays the category of the entry.
Source IP	This field displays the source IP address of traffic that you want to trace.
Destination IP	This field displays the destination IP address of traffic.

5.8 The IPS Screen

Click **Security Statistics > IPS** to display the following screen. This screen displays IPS (Intrusion Prevention System) statistics. An IPS system can detect malicious or suspicious packets and respond instantaneously by rejecting or dropping the packets. The Zyxel Device IPS protects your network against network-based intrusions.

If a license has expired, you will see a reminder in this screen. You need to renew the license in order to keep using the feature. Click **Buy Now** to go to Marketplace to purchase a new license. Click **See Details** to go to the Zyxel web page to find more information on licenses for your Zyxel Device.

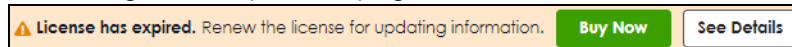
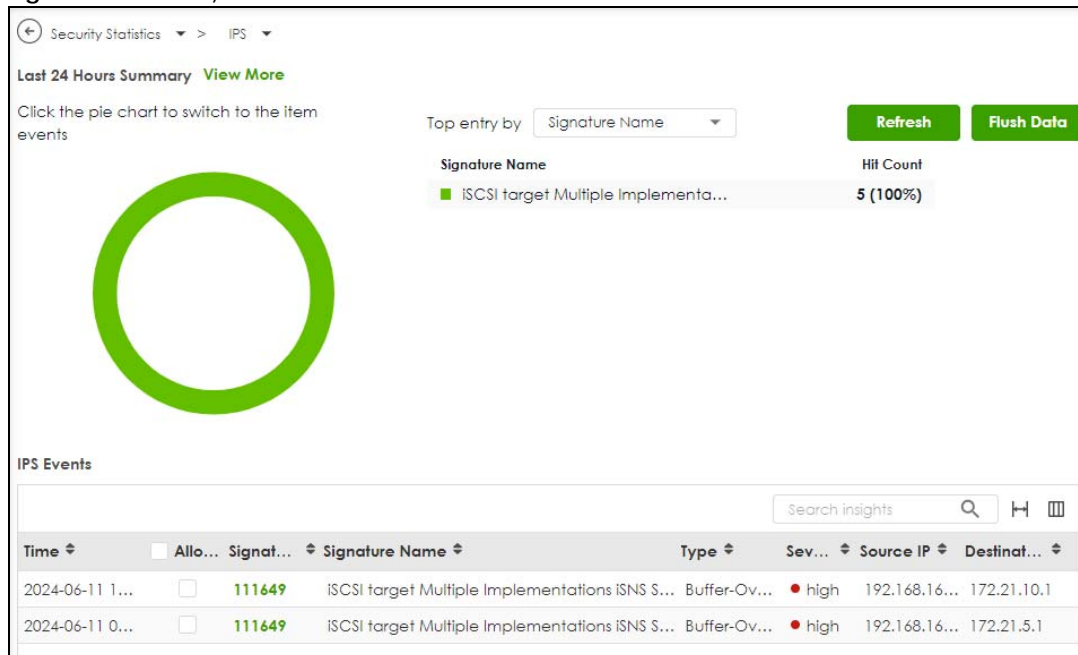

Figure 75 Security Statistics > IPS



The following table describes the labels in this screen.

Table 37 Security Statistics > IPS

LABEL	DESCRIPTION
Last 24 Hours Summary	If you want to view more data than the past 24 hours in SecuReporter, click View More . You should already have a SecuReporter account.
Pie Chart	Click an item in the pie chart for more detailed information.

Table 37 Security Statistics > IPS

LABEL	DESCRIPTION
Top Entries By	Use this field to have the following (read-only) table display the top IPS log entries by Signature Name , Source IP or Destination IP . This table displays the most common, recent IPS logs. See the log screen for less common IPS logs or use a syslog server to record all IPS logs. Select Signature Name to list the most common signatures that the Zyxel Device has detected. Select Source IP to list the source IP addresses from which the Zyxel Device has detected the most intrusion attempts. Select Destination IP to list the most common destination IP addresses for intrusion attempts that the Zyxel Device has detected.
Refresh	Click this button to update the report display.
Flush Data	Click this button to discard all of the screen's statistics. Click Refresh to update the report display.
Time	This column displays the date and time IPS blocked this IP address.
+ Allow List	Select an entry and click this to add the signature to the IPS allow list.
Signature ID	This column displays when you display the unique value given to each intrusion detected.
Signature Name	This column displays the name to identify the type of intrusion pattern.
Type	This column displays the categories of intrusions.
Severity	This column displays the level of threat that the intrusions may pose.
Source IP	This column displays the source IP address of the intrusion attempts.
Destination IP	This column displays the destination IP address at which intrusion attempts were targeted.

5.9 The Anti-Malware Screen

Click **Security Statistics > Anti-Malware** to display the following screen. This screen displays anti-malware statistics.

If a license has expired, you will see a reminder in this screen. You need to renew the license in order to keep using the feature. Click **Buy Now** to go to Marketplace to purchase a new license. Click **See Details** to go to the Zyxel web page to find more information on licenses for your Zyxel Device.

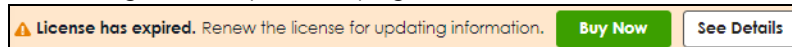
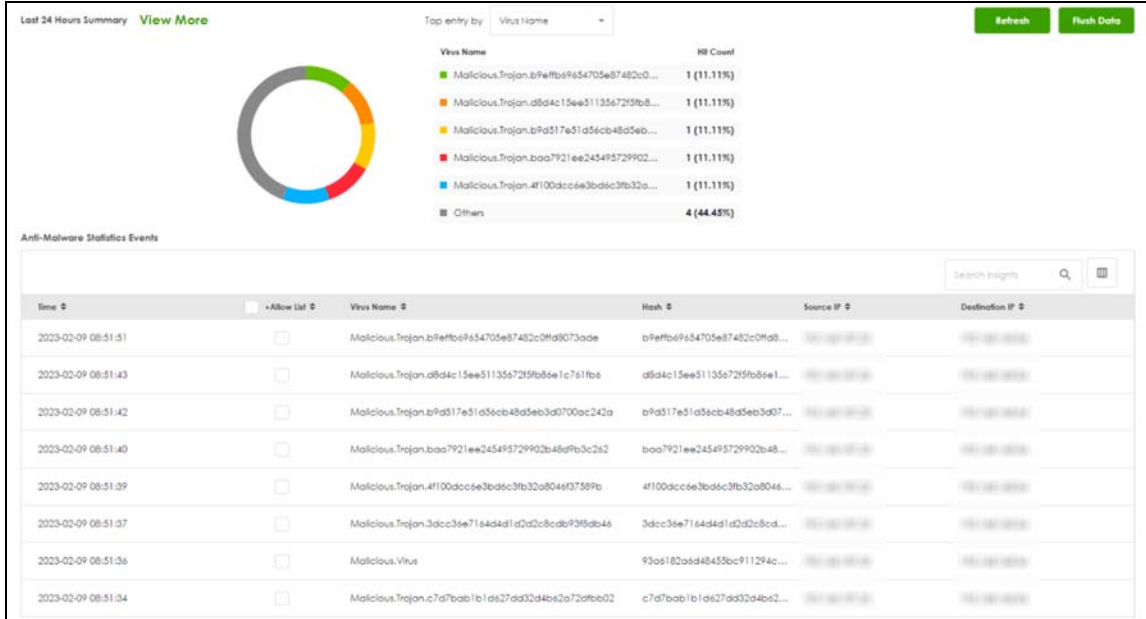

Figure 76 Security Statistics > Anti-Malware



The following table describes the labels in this screen.

Table 38 Security Statistics > Anti-Malware

LABEL	DESCRIPTION
Last 24 Hours Summary	If you want to view more data than the past 24 hours in SecuReporter, click View More . You should already have a SecuReporter account.
Pie Chart	Click an item in the pie chart for more detailed information.
Top Entries By	Use this field to have the following (read-only) table display the top anti-malware log entries by Virus Name , Source IP , and Destination IP . This table displays the most common, recent anti-malware logs. See the log screen for less common anti-malware logs or use a syslog server to record all anti-malware logs. Select Virus Name to list the most common viruses that the Zyxel Device has detected. Select Source IP to list the source IP addresses from which the Zyxel Device has detected the most virus-infected files. Select Destination IP to list the most common destination IP addresses for virus-infected files that Zyxel Device has detected.
Refresh	Click this button to update the report display.
Flush Data	Click this button to discard all of the screen's statistics. Click Refresh to update the report display.
Anti-Malware Statistics Events	
Time	This field displays the date and time the entry was created.
+ Allow List	Select an entry and click this to add it to the anti-malware allow list.
Virus name	This column displays when you display the entries by Virus Name . This displays the name of a detected virus.
Hash	This column displays a hash value, MD5 (Message Digest 5) of the detected virus file. MD5 is hash algorithms used to authenticate packet data.

Table 38 Security Statistics > Anti-Malware (continued)

LABEL	DESCRIPTION
Source IP	This column displays when you display the entries by Source IP . It shows the source IP address of virus-infected files that the Zyxel Device has detected.
Destination IP	This column displays when you display the entries by Destination IP . It shows the destination IP address of virus-infected files that the Zyxel Device has detected.

5.10 The Sandbox Screen

Click **Security Statistics > Sandbox** to display the following screen. This screen displays sandbox statistics.

If a license has expired, you will see a reminder in this screen. You need to renew the license in order to keep using the feature. Click **Buy Now** to go to Marketplace to purchase a new license. Click **See Details** to go to the Zyxel web page to find more information on licenses for your Zyxel Device.

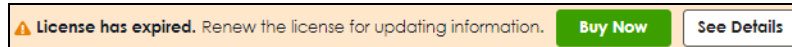
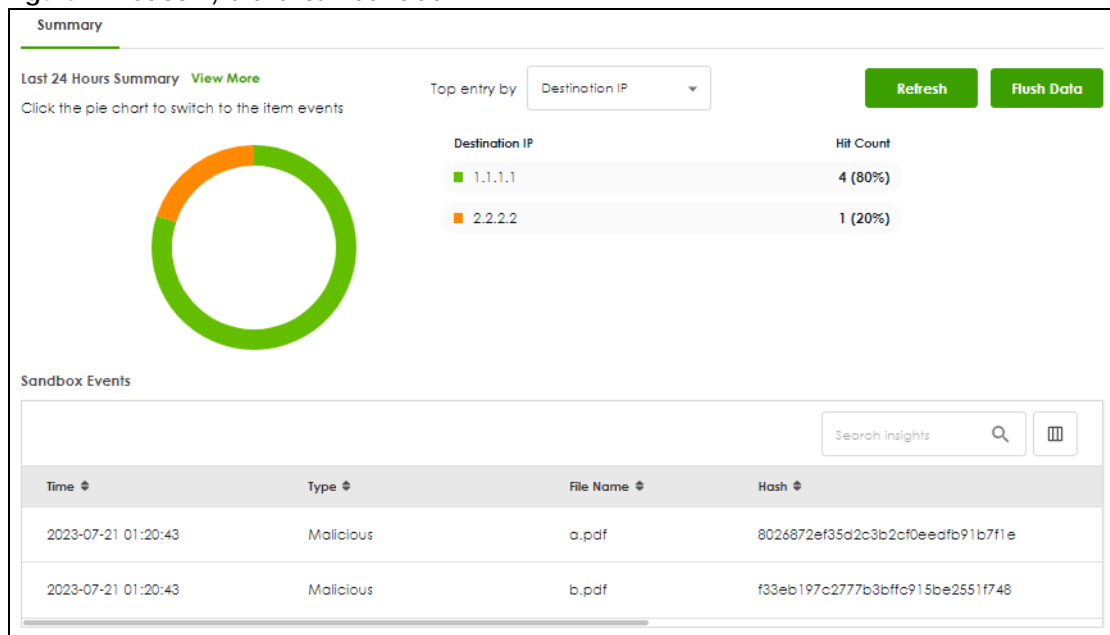

Figure 77 Security Statistics > Sandbox



The following table describes the labels in this screen.

Table 39 Security Statistics > Sandbox

LABEL	DESCRIPTION
Last 24 Hours Summary	If you want to view more data than the past 24 hours in SecuReporter, click View More . You should already have a SecuReporter account.
Pie Chart	Click an item in the pie chart for more detailed information.

Table 39 Security Statistics > Sandbox (continued)

LABEL	DESCRIPTION
Top Entries By	<p>Use this field to have the following (read-only) table display the top sandbox log entries by Destination IP, Source IP and Type. This table displays the most common, recent sandbox logs. See the log screen for less common sandbox logs or use a syslog server to record all sandbox logs.</p> <p>Select Source IP to list the source IP addresses from which the Zyxel Device has detected the most files with unknown or untrusted programs and codes.</p> <p>Select Destination IP to list the most common destination IP addresses for files with unknown or untrusted programs and codes that Zyxel Device has detected.</p> <p>Select Type to display if the file type of the detected file with unknown or untrusted programs and codes.</p>
Refresh	Click this button to update the report display.
Flush Data	<p>Click this button to discard all of the screen's statistics. Click Refresh to update the report display.</p> <p>When the statistics stored reach the limit, new statistics automatically overwrite existing statistics, starting with the oldest statistics first.</p>
Sandbox Events	
Time	This field displays the time the file is scanned by the Zyxel Device.
Type	This field displays the file type of the detected file with unknown or untrusted programs and codes.
File Name	This column displays the file name of the detected virus file.
Hash	<p>This column displays a hash value, MD5 (Message Digest 5, of the detected file with unknown or untrusted programs and codes.</p> <p>MD5 is a hash algorithm used to authenticate packet data.</p>
Source IP	This column displays the source IP address of the file the Zyxel Device has checked.
Destination IP	This column displays the destination IP address at which the traffic of the file the Zyxel Device has checked is sent.

5.11 The SSL Inspection Screens

The Zyxel Device uses SSL Inspection to decrypt SSL traffic, then sends it to Security Service engines for inspection, and then finally encrypts traffic that passes inspection and forwards it.

5.11.1 The Summary Screen

Click **Security Statistics > SSL Inspection > Summary** to display the following screen. This screen shows the number of SSL sessions inspected, blocked and passed.

Figure 78 Security Statistics > SSL Inspection > Summary

Summary		Certificate Cache List
General Settings		
<input type="button" value="Refresh"/> <input type="button" value="Flush Data"/>		
Status		
Maximum Concurrent Sessions		1000
Concurrent Sessions		2
Summary		
SSL Sessions	Total	0
	Inspected	0 (0%)
	Decrypted	0 bytes
	Encrypted	0 bytes
	Blocked	0
	Passed	0

The following table describes the labels in this screen.

Table 40 Security Statistics > SSL Inspection > Summary

LABEL	DESCRIPTION
General Settings	
Refresh	Click this button to update the report display.
Flush Data	Click this button to discard all of the screen's statistics. Click Refresh to update the report display.
Status	
Maximum Concurrent Sessions	This shows the maximum number of simultaneous SSL Inspection sessions allowed for your Zyxel Device model.
Concurrent Sessions	This shows the actual number of simultaneous SSL Inspection sessions in progress.
Summary	
Total	This is the total of SSL sessions inspected and number of sessions blocked and number of sessions passed since data was last flushed or the Zyxel Device last rebooted after Collect Statistics was enabled.
Inspected	This shows the total number of SSL sessions inspected since data was last flushed or the Zyxel Device last rebooted after Collect Statistics was enabled
Decrypted (Kbytes)	This shows the number of kilobytes (KB) of data that was decrypted for Security Service inspection.
Encrypted (Kbytes)	This shows the number of kilobytes (KB) of data that was re-encrypted after Security Service inspection and then forwarded.
Blocked	This shows the number of SSL sessions blocked.
Passed	This shows the number of SSL sessions passed.

5.11.2 The Certificate Cache List Screen

A certificate identifies the source of SSL traffic. Use this screen to decide which sources can be excluded from SSL inspection. Traffic in an **Exclude List** is not intercepted by SSL inspection.

Click **Security Statistics > SSL Inspection > Certificate Cache List** to display a screen that shows details on SSL traffic identified by its certificate and an option to add that traffic to the **Exclude List**.

Figure 79 Security Statistics > SSL Inspection > Certificate Cache List



The following table describes the labels in this screen.

Table 41 Security Statistics > SSL Inspection > Certificate Cache List

LABEL	DESCRIPTION
Time	This is the latest date (yyyy-mm-dd) and time (hh-mm-ss) that the record in the certificate cache list was met.
Add to Exclude list	Select and item in the list and click this icon to add the common name (CN) to the Exclude List .
Common Name	This displays the common name in the certificate of the SSL traffic destination server.
Server Name Indication	Server Name Indication (SNI) is the domain name entered in the browser, FTP client, etc. to begin the SSL session with the server. It allows multiple SSL sessions to the same IP address and port number with different certificates from different SNI. This field displays the SNI for this SSL session.
SSL Version	This field shows the SSL version. TLS1.0/1.1/1.2 are currently supported.
Destination	This displays the IP address and port number of the SSL traffic destination server.
Valid Time	This displays the cache item expiry time in seconds. The cache item is deleted when the remaining time expires.

5.12 The Interface Screen

This screen lists all of the Zyxel Device's interfaces and their information.

Click **Network Status > Interface** to display the following screen.

Figure 80 Network Status > Interface

The screenshot shows the 'Network Status > Interface' page. It features a 'Refresh' button in the top right. The page is divided into four sections: External, Internal, General, and VTI. Each section contains a table of interface details with columns for Name, Members, Type, Status, Zone, IP Addr/Netmask, VLAN ID, IP Assignment, and Service. The External section shows ge1 and ge2. The Internal section shows ge3 and ge4. The General section shows koala_gen. The VTI section shows vti_wizard_772.

Name	Members	Type	Status	Zone	IP Addr/Netmask	VLAN ID	IP Assignment	Service
ge1	p1	Ethernet	1000M/Full	WAN			DHCP Client	n/a
ge2	p2	Ethernet	Down	WAN			DHCP Client	n/a

Na...	Members	Type	Status	Zo...	IP Addr/Netmask	VLAN...	IP Assignm...	Service
ge3	p3,p4,p5,p6	Ethernet	100M/Full,Down,Down,D...	LAN	192.168.168.1/255.255.2...		Static	DHCP Server
ge4	p7,p8,p9,p10	Ethernet	Down,Down,Down,Down	LAN	192.168.169.1/255.255.2...		Static	DHCP Server

Name	Members	Type	Status	Zone	IP Addr/Netmask	VLAN ID	IP Assignment	Service
koala_gen	p11,p12	Ethernet	Down,Down	koala_z			Unassigned	-

Name	Zone	IP Addr/Netmask	VPN Rule
vti_wizard_772	IPSec_VPN		KoalaVPN

The following table describes the labels in this screen.

Table 42 Network Status > Interface

LABEL	DESCRIPTION
Refresh	Click this to update the information in this screen.
Name	This field displays the name of each interface.
Members	This field displays the physical port number that is bonded to the interface. An interface is bonded to a port when the interface is bounded to the physical port. When you create a bridge interface, the Zyxel Device removes the members' entries from the routing table and adds the bridge interface's entries to the routing table. This field displays the bridge interface's members
Type	This field displays the type of connection the interface is using.

Table 42 Network Status > Interface

LABEL	DESCRIPTION
Status	<p>This field displays the current status of each interface. The possible values depend on what type of interface it is.</p> <p>For Ethernet interfaces:</p> <ul style="list-style-type: none"> • Inactive - The Ethernet interface is disabled. • Down - The Ethernet interface does not have any physical ports associated with it or the Ethernet interface is enabled but not connected. • Speed / Duplex - The Ethernet interface is enabled and connected. This field displays the port speed and duplex setting (Full or Half). <p>For the auxiliary interface:</p> <ul style="list-style-type: none"> • Inactive - The auxiliary interface is disabled. • Connected - The auxiliary interface is enabled and connected. • Disconnected - The auxiliary interface is not connected. <p>For virtual interfaces, this field always displays Up. If the virtual interface is disabled, it does not appear in the list.</p> <p>For VLAN and bridge interfaces, this field always displays Up. If the VLAN or bridge interface is disabled, it does not appear in the list.</p> <p>For PPP interfaces:</p> <ul style="list-style-type: none"> • Connected - The PPP interface is connected. • Disconnected - The PPP interface is not connected. <p>If the PPP interface is disabled, it does not appear in the list.</p>
Zone	This field displays the zone to which the interface is assigned.
IP Addr/Netmask	<p>This field displays the current IP address and subnet mask assigned to the interface. If the IP address and subnet mask are 0.0.0.0, the interface is disabled or did not receive an IP address and subnet mask via DHCP.</p> <p>If this interface is a member of an active virtual router, this field displays the IP address it is currently using. This is either the static IP address of the interface (if it is the master) or the management IP address (if it is a backup).</p>
VLAN ID	This field displays the VLAN ID which is a 12-bit number that uniquely identifies each VLAN.
IP Assignment	<p>This field displays how the interface gets its IP address.</p> <ul style="list-style-type: none"> • Static - This interface has a static IP address. • DHCP Client - This interface gets its IP address from a DHCP server.
Service	This field lists which services the interface provides to the network. Examples include DHCP relay , DHCP server and DDNS . This field displays n/a if the interface does not provide any services to the network.
VPN Rule	This field displays the scenario rule the VPN tunnel interface is using.

5.13 The Device Insight Screen

Use **Device Insight** to collect status and basic information of the clients connected to the Zyxel Device internal interfaces or IPsec VPN or Astra clients with or without VPN Zyxel Client software installed. The clients shown may include clients connected to the Zyxel Device:

- Using wired connections.
- Through access points (APs) using wired connections.
- Through access points (APs) using WiFi connections.

- Through built-in access points using WiFi connections.
- Using SecuExtender (IPSec VPN clients).

Device Insight collects client information including:

- Hostname
- IP address and MAC address
- Operating system
- Category, such as mobile phones or computers
- Connected interface

Note: To collect clients' information using **Device Insight**, the clients must be in the same IP subnet in the LAN/VLAN/DMZ networks behind the Zyxel Device. Information from clients that are in different IP subnets in the LAN/VLAN/DMZ networks might not be collected correctly as traffic must pass through another router or a layer-3 switch to the Zyxel Device.

In the graphic below, **A** is a client connected to the Zyxel Device using a wired connection. **B** is a client connected to the Zyxel Device through an AP using a wired connection. **C** is a client connected to the Zyxel Device through an AP using a WiFi connection.

Figure 81 Clients' Device Insight Example

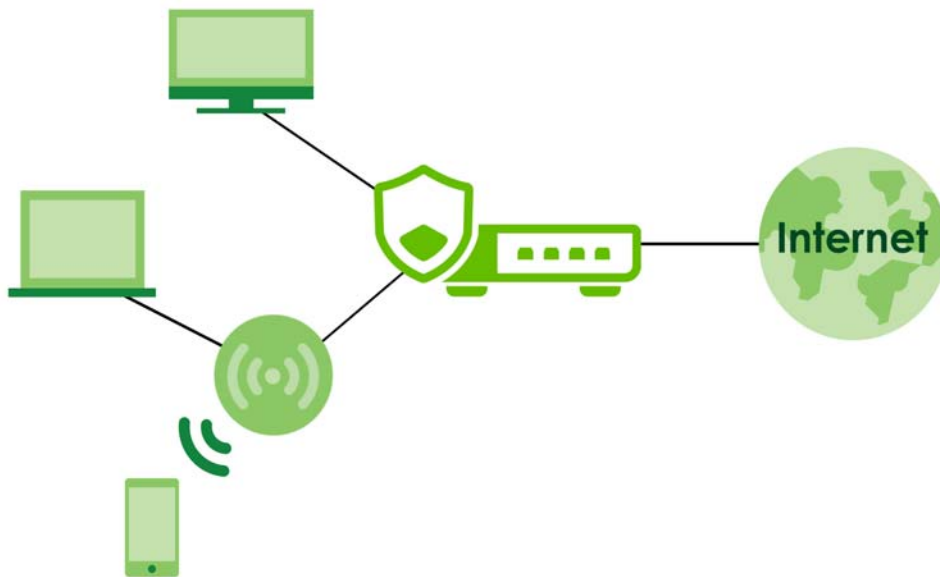

Click **Network Status > Device Insight** to show the following screen.

If a license has expired, you will see a reminder in this screen. You need to renew the license in order to keep using the feature. Click **Buy Now** to go to Marketplace to purchase a new license. Click **See Details** to go to the Zyxel web page to find more information on licenses for your Zyxel Device.

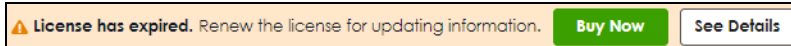

Figure 82 Network Status > Device Insight

Status	MAC A...	IP Address	Hostname	Description	Category	Operating System ...	Type	Last Seen	User	Connected to
Online	88c7abc3...	192.168.1.101			Mobile Phone/Tablet	Android	Google Android	2023-07-21 10:17:07	ge3	
Online	74d02b...	192.168.1.102	android-05d7fe57f6...		Mobile Phone/Tablet	Android	Asus Android	2023-07-21 10:18:29	ge3	
Offline	000eac...	192.168.1.103	TWPCNT02270-ASUSn8		Computer	Windows	Microsoft Window...	2023-07-20 10:49:17	ge3	
Online	a0e4ict...	192.168.1.104	nwa5123-ni		Wireless AP	Linux	Zyxel NWA5123-Ni	2023-07-21 10:08:23	ge3	
Offline	a05142...	192.168.1.105	android-7255c74e42...		Mobile Phone/Tablet	Android	Sony Android	2023-07-21 10:18:30	ge3	

The following table describes the labels in this screen.

Table 43 Network Status > Device Insight

LABEL	DESCRIPTION
Edit	Double-click an entry or select it and click Edit to modify the entry's settings in the Description field.
Remove	Select an entry and click Remove to remove a client from the table that's no longer connected to your network. For example, guest A visited your company over a month ago. Guest A used his cellphone to connect to your Zyxel Device networks. His cellphone was identified and shown in the Device Insight table. Guest A has left for over a month and you're sure he will not return in the near future. You can use the Remove button to remove his device from this table. Guest A's device will be identified and shown in the table again if he connects to your Zyxel Device networks in the future. Please note that clients that are blocked cannot be removed. Make sure to unblock clients before you remove them.
Add to block list	Select an entry and click Add to block list to stop the selected client from connecting to the Zyxel Device.
Remove from block list	Select an entry and click Remove from block list to allow the selected client to connect to the Zyxel Device.
Feedback	Select an entry and click Feedback to report on a client that is wrongly identified regarding its Category , Operating System or Type .
Status	This field displays the status of the clients. Online (🟢) - The connection between the client and the Zyxel Device is up. Offline (🔴) - The connection between the client and the Zyxel Device is down. Block (🚫) - The client is blocked from the connection to the Zyxel Device.
MAC Address	This field displays the MAC address of the client.
MAC Vendor	This displays the MAC address Organizationally Unique Identifier (OUI). The OUI is the first three octets in a MAC address and uniquely identifies the manufacturer of a network device.
IP Address	This field displays the IP address of the client.
Hostname	This field displays the name used to identify this device on the network.
Description	This field displays the descriptive name of the client.
Connected to	This field displays the interface to which a client is connected directly to on the Zyxel Device.
Connected to	This field displays the interface to which a client is connected directly to on the Zyxel Device.
Operating System (OS)	This field displays the operating system of the client.

Table 43 Network Status > Device Insight (continued)

LABEL	DESCRIPTION
OS Version	This field displays the version of the operating system of the client.
Type	This field displays the model names of the client.
First-seen	This field displays the time when the client first sends traffic to the Zyxel Device since the Zyxel Device last reboot.
Last-seen	This field displays the time when the client last sends traffic to the Zyxel Device.
User	This field displays the type of user account the client uses. See Section 25.1.1 on page 389 for more information the user account types.
Auth method	This field displays the authentication method that is used to authenticate the client.
Astra Group & Role	This field displays the group name and role (admin or member) of the client on Astra. <ul style="list-style-type: none"> admin: The Astra web portal is a platform that provides security services to computer or mobile devices. It is managed by an admin. member: A member is a person whose computer or mobile device the admin wishes to protect using Astra. You can add your mobile device or a member's mobile device using this Astra web portal account.
Astra Agent Version	This field displays the version of Astra.
Client Firewall Status	This field displays the firewall status on the client's computer or mobile device, such as a smartphone. The field is blank if there is no firewall on the client. <ul style="list-style-type: none"> Enabled: The firewall is enabled on the client. Disabled: The firewall is disabled on the client.
Astra License Status	This field displays the current Astra license status of the client. The following displays for a license you subscribed to from the Astra Portal. <ul style="list-style-type: none"> Activated: The Astra license is enabled. Inactive: The Astra license is not enabled. Overdue: The payment for the Astra license has failed, and the license will be canceled 15 days after the overdue date. During this period, attempts will be made to process the credit card payment. Cancel: The Astra license will be canceled after the expiration date. None: A standard or trial license has not been enabled. The following displays for a license you purchased offline. You'll need to use the license key to activate the license online. <ul style="list-style-type: none"> Activated: The Astra license is enabled. Grace period: After a license expires, you have 15 days grace period during which you can extend your current license. Expired: The Astra license has expired. None: A standard or trial license has not been enabled.

5.14 The Login Users Screen

Use this screen to see a list of users currently logged into the Zyxel Device. To access this screen, click **Network Status > Login Users**.

Figure 83 Network Status > Login Users

The screenshot shows a web interface for 'Network Status > Login Users'. At the top, there is a 'Force log Out' button and a search input field. Below is a table with the following columns: #, User ID, Role, From, Login time, Type, Tunnel IP, and Reauth/Lease time. Five rows of data are visible, all for 'admin' users with 'http/https' login type and '0.0.0.0' tunnel IP. The 'From' column shows IP addresses like 192.168.1.1. The 'Login time' column shows durations like '12 days, 4:18:11'. The 'Reauth/Lease time' column shows 'unlimited / unlimited'.

#	User ID	Role	From	Login time	Type	Tunnel IP	Reauth/Lease time
1	admin	admin	192.168.1.1	12 days, 4:18:11	http/https	0.0.0.0	unlimited / unlimited
2	admin	admin	192.168.1.1	12 days, 0:55:47	http/https	0.0.0.0	unlimited / unlimited
3	admin	admin	192.168.1.1	12 days, 7:58:48	http/https	0.0.0.0	unlimited / unlimited
4	admin	admin	192.168.1.1	12 days, 3:28:04	http/https	0.0.0.0	unlimited / unlimited
5	admin	admin	192.168.1.1	12 days, 2:45:18	http/https	0.0.0.0	unlimited / unlimited

The following table describes the labels in this screen.

Table 44 Network Status > Login Users

LABEL	DESCRIPTION
Force Logout	Select a user row and click this icon to end a user's session.
#	This field is a sequential value and is not associated with any entry.
User ID	This field displays the user name of each user who is currently logged in to the Zyxel Device.
Role	This field displays the types of user accounts the Zyxel Device uses. See Section 25.1.2 on page 390 for more information on the user accounts.
From	This field displays the IP address of the computer used to log in to the Zyxel Device.
Login Time	This field displays how long a user account has logged into the Zyxel Device.
Type	This field displays the way the user logged into the Zyxel Device. The user can log into the Zyxel Device using HTTP, HTTPS, SSH, FTP and console.
Tunnel IP	This field displays the IP address of the VPN tunnel a user account is using to access the Zyxel Device. This field displays 0.0.0.0 if a user account is not accessing the Zyxel Device through a VPN tunnel.
Reauth/Lease Time	This field displays the amount of reauthentication time remaining and the amount of lease time remaining for each user. See Section 25.1.3 on page 392 for more information on the reauthentication time and lease time.

5.15 The Lockout IPs Screen

Use this screen to view and unlock IP addresses blocked from logging in to the Zyxel Device. If a user exceeds the limit on the number of unsuccessful login attempts (for example, wrong password), the Zyxel Device will lock the IP address for a specified amount of time. Go to **User & Authentication > User/Group > Setting** to configure these user account lockout settings. See [Section 25.1.5 on page 397](#) for more information.

Note: A user account that has exceeded the login attempt limit can still log into the Zyxel Device from another IP address that is not blocked.

To access this screen, click **Network Status > Login Users > Lockout IPs**.

Figure 84 Network Status > Login Users > Lockout IPs

#	IP	Last User ID	Role	Lockout Time
1		admin	admin	00:00:27

The following table describes the labels in this screen.

Table 45 Network Status > Login Users > Lockout IPs

LABEL	DESCRIPTION
Unlock	Select an IP address and click Unlock to allow the user from that IP address to log into the Zyxel Device.
#	This field is a sequential value and is associated with the lockout IP address entries.
IP	This displays the IP address that exceeded the login attempt limit.
Last User ID	This displays the user name of the user who exceeded the login attempt limit.
Role	This displays the type of user account that attempted to log into the Zyxel Device. <ul style="list-style-type: none"> Admin: This user can configure the Zyxel Device settings using the web configurator or CLI. Viewer: This user can only view the Zyxel Device settings using the web configurator and perform basic diagnostics for troubleshooting using the command line interface (CLI). User: This user has access to the Zyxel Device's services, such as VPN, and can also browse. This user cannot configure or view the Zyxel Device settings using the web configurator or CLI. External User: This user account is maintained on a remote server, such as RADIUS or LDAP. This user has access to the Zyxel Device's services, such as VPN, and can also browse but cannot configure or view the Zyxel Device settings using the web configurator or CLI.
Lockout Time	This displays how long the IP address has been blocked by the Zyxel Device.

5.16 The DHCP Table Screen

Use this screen to look at a list of interfaces and their DHCP-assigned IP addresses. To access this screen, click **Network Status > DHCP Table**.

Figure 85 Network Status > DHCP Table

Interface	IP Address	Host Name	MAC Address	VLAN ID	Expire Time	Status
ge4	192.168.169.33	NT121748-N802	48:9e:bd:35:7b:9b		2024-09-19 23:38:48	-

The following table describes the labels in this screen.

Table 46 Network Status > DHCP Table

LABEL	DESCRIPTION
Current DHCP List	
Interface	Select a Zyxel Device interface that has DHCP enabled to show to which devices it has assigned DHCP IP addresses.
Add	<p>Click this to add an entry that maps a static IP to a MAC address.</p> 
Release	Select an entry and click on this button to let other devices use the dynamic DHCP that is currently assigned to the selected entry.
Reserved	Select an entry and click on this button to make the entry a static DHCP entry, meaning the DHCP client is always assigned the same IP address from the DHCP server.
Unreserve	Select an entry and click on this button to change the entry from a static DHCP entry to a dynamic DHCP entry, meaning the DHCP client may get a different IP address from the DHCP server when the IP address is renewed.
Export	Click this button to download all entries in the DHCP table to your computer in csv format with file name containing the current date.
Refresh	Click this button to update the mapping between IP addresses and MAC addresses.
Column header	Click a column's heading cell to sort the table entries by the column entry. Click the heading cell again to reverse the sort order.
Interface	This field identifies the interface that assigned an IP address to a DHCP client.
IP Address	This field displays the IP address currently assigned to a DHCP client or reserved for a specific MAC address. Click the column's heading cell to sort the table entries by IP address. Click the heading cell again to reverse the sort order.
Host Name	<p>This field displays the name used to identify this device on the network (the computer name). The Zyxel Device learns these from the DHCP client requests. None shows here for a static DHCP entry.</p> <p>A host name cannot exceed 255 characters. Valid characters are [0-9][a-z][A-Z][_ -].</p> <p>Note: You cannot have duplicate host names for static (reserved) IP addresses.</p>
MAC Address	This field displays the MAC address to which the IP address is currently assigned or for which the IP address is reserved. The MAC address format can be "xx:xx:xx:xx:xx:xx" or "xx-xx-xx-xx-xx-xx"
VLAN ID	This field displays the VLAN to which the IP address belongs, if any.
Expire Time	This displays the date and time the DHCP-assigned address will be renewed.

Table 46 Network Status > DHCP Table (continued)

LABEL	DESCRIPTION
Description	This field displays a description of the DHCP client to identify it. The description cannot exceed 64 characters. Valid characters are [0-9][a-z][A-Z][_ -]. Note: You can only edit the description for clients with static (reserved) IP addresses.
Status	This field displays the connection status of the DHCP client. Reserved means a static DHCP entry. - means a dynamic DHCP entry.

5.17 The IPsec VPN Screen

Click a column's heading cell to sort the table entries by that column's criteria. Click the heading cell again to reverse the sort order.

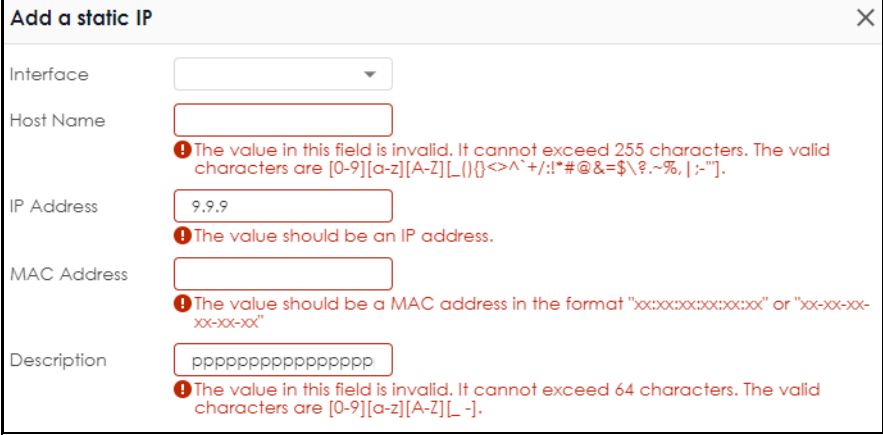
5.17.1 The Site to Site VPN Screen

Use this screen to display and to manage active IPsec SAs.

To access this screen, click **VPN Status > IPsec VPN > Site to Site VPN**. The following screen appears.

Figure 86 VPN Status > IPsec VPN > Site to Site VPN

Each field is described in the following table.

Table 47 VPN Status > IPsec VPN > Site to Site VPN

LABEL	DESCRIPTION
Disconnect	Select an IPsec SA and click this button to disconnect it.
Refresh	Select an IPsec SA and click this button to update its status.
#	This field is a sequential value, and it is not associated with a specific SA.
Name	This field only displays the client names if they're using EAP or X-auth for authentication. If a client is connected to the Zyxel Device without using Extended Authentication Protocol (EAP) or X-Auth, this field will be empty.
Remote Gateway	This field displays the IP address of the remote gateway.
Remote ID	This field displays the ID of the remote gateway.
My Address	This field displays the IP address of the Zyxel Device.
Policy Route	This field displays the content of the local and remote policies for this IPsec SA. The IP addresses, not the address objects, are displayed.

Table 47 VPN Status > IPsec VPN > Site to Site VPN (continued)

LABEL	DESCRIPTION
Uptime	This field displays how many seconds the IPsec SA has been active. This field displays N/A if the IPsec SA uses manual keys.
Rekey	This field displays how many seconds remain in the SA life time, before the Zyxel Device automatically disconnects the IPsec SA. This field displays N/A if the IPsec SA uses manual keys.
Inbound (Bytes)	This field displays the amount of traffic that has gone through the IPsec SA from the remote IPsec router to the Zyxel Device since the IPsec SA was established.
Outbound (Bytes)	This field displays the amount of traffic that has gone through the IPsec SA from the Zyxel Device to the remote IPsec router since the IPsec SA was established.

5.17.2 The Remote Access VPN Screen

Use this screen to display or disconnect remote access VPN clients that are connected to the Zyxel Device. The remote access VPN clients must have SecuExtender or use supported computer or mobile operating systems; see [Section 12.4 on page 209](#) for more information.

To access this screen, click **VPN Status > IPsec VPN > Remote Access VPN**. The following screen appears.

Figure 87 VPN Status > IPsec VPN > Remote Access VPN

#	Username	Assigned IP	Remote IP	Up Time	Reauth/Lease Time	Inbound (bytes)	Outbound (Bytes)
1	admin	192.168.50.1	192.168.101.36	0:00:13	23:59:47/23:59:47	1441	1559

Each field is described in the following table.

Table 48 VPN Status > IPsec VPN > Remote Access VPN

LABEL	DESCRIPTION
Disconnect	Select a remote access VPN client and click this button to disconnect it.
Refresh	Click Refresh to update this screen.
#	This field is a sequential value, and it is not associated with a specific remote access VPN client.
Username	This field displays the name of the remote access VPN client.
Assigned IP	This field displays the IP address the user used to establish this remote access VPN connection.
Remote IP	This field displays the IP address of the remote IPsec router the remote access VPN client is connected to.
Up Time	This field displays how many seconds the remote access VPN client has been active. This field displays N/A if the remote access VPN client uses manual keys.
Reauth/Lease Time	This field displays the amount of reauthentication time remaining and the amount of lease time remaining for each remote access VPN client.
Inbound (Bytes)	This field displays the number of bytes received by the Zyxel Device on this connection.
Outbound (Bytes)	This field displays the number of bytes transmitted by the Zyxel Device on this connection.

5.18 The SSL VPN Screen

The Zyxel Device keeps track of the SSL VPN clients who are currently logged into the Zyxel Device. Use this screen to:

- View a list of active SSL VPN connections.
- Log out individual users and delete related session information.

Once a user logs out, the corresponding entry is removed from the screen.

The SSL VPN clients must have SecuExtender or use supported computer or mobile operating systems; see [Section 13.2 on page 229](#) for more information.

Click **VPN Status > SSL VPN > Remote Access VPN** to display the following screen.

Figure 88 VPN Status > SSL VPN > Remote Access VPN

#	Username	Assigned IP	Remote IP	Up Time	Reauth/Lease Time	Inbound (Bytes)	Outbound (Bytes)
1	admin	192.168.51.8	192.168.104.33	08:03:09	22:22:05 / 22:22:05	2075(2075 bytes)	4825(4825 bytes)

The following table describes the labels in this screen.

Table 49 VPN Status > SSL VPN > Remote Access VPN

LABEL	DESCRIPTION
Disconnect	Select a connection and click this button to terminate the user's connection and delete corresponding session information from the Zyxel Device.
Refresh	Click Refresh to update this screen.
#	This field is a sequential value, and it is not associated with a specific SSL.
Username	This field displays the account user name used to establish this SSL VPN connection.
Assigned IP	This field displays the IP address the user used to establish this SSL VPN connection.
Remote IP	This field displays the remote SSL VPN router the SSL VPN is connected to.
Up Time	This field displays how many seconds the SSL VPN client has been active. This field displays N/A if the SSL VPN client uses manual keys.
Reauth/Lease Time	This field displays the amount of reauthentication time remaining and the amount of lease time remaining for each SSL VPN client.
Inbound (Bytes)	This field displays the number of bytes received by the Zyxel Device on this connection.
Outbound (Bytes)	This field displays the number of bytes transmitted by the Zyxel Device on this connection.

5.18.1 Regular Expressions in Searching IPsec SAs

A question mark (?) lets a single character in the VPN connection or policy name vary. For example, use "a?c" (without the quotation marks) to specify abc, acc and so on.

Wildcards (*) let multiple VPN connection or policy names match the pattern. For example, use "*abc" (without the quotation marks) to specify any VPN connection or policy name that ends with "abc". A VPN connection named "testabc" would match. There could be any number (of any type) of characters in front of the "abc" at the end and the VPN connection or policy name would still match. A VPN connection or policy name named "testacc" for example would not match.

A * in the middle of a VPN connection or policy name has the Zyxel Device check the beginning and end and ignore the middle. For example, with "abc*123", any VPN connection or policy name starting with "abc" and ending in "123" matches, no matter how many characters are in between.

The whole VPN connection or policy name has to match if you do not use a question mark or asterisk.

CHAPTER 6

Licensing

6.1 Licensing Overview

Use the **Licensing** screens to register your Zyxel Device and manage its service subscriptions.

- Use the **Licenses** screen to refresh Zyxel Device registration. Go to nebula.zyxel.com to register your Zyxel Device and activate a service, such as content filtering.
- Use the **Signature Update** screen to download the latest signatures for your licensed services.

Please note that you cannot use the security services and upgrade firmware if your Zyxel Device is not registered at NCC or the services do not have a license. Your Zyxel Device and network will be exposed to threats and attacks. We strongly recommend you to register your Zyxel Device and purchase a license at NCC to better protect your Zyxel Device and network.

6.1.1 What you Need to Know

This section introduces the topics covered in this chapter.

Subscription Services Available

See **Licensing > Signature Update** for the subscription services that your Zyxel Device supports. You can extend a service at **NCC > Organization-wide > License & Inventory**.

Signature Update

- You need a valid service registration to update the Application Patrol signatures, IPS signatures and IP Reputation signatures.
- Schedule signature updates for a day and time when your network is least busy to minimize disruption to your network.

Note: The Zyxel Device does not have to reboot when you upload new signatures.

Features Available Without a License

You can use the following Zyxel Device features without a license:

Table 50 Features Available Without a License

MONITOR	CONFIGURATION	MAINTENANCE
System Statistics	Network	Maintenance
Network Status	VPN	
VPN Status	Security Policy	
	Object	
	User & Authentication	

Table 50 Features Available Without a License

MONITOR	CONFIGURATION	MAINTENANCE
	System	
	Log & Report (except SecuReporter)	

6.1.2 The Licenses Screen

Use this screen to display the status of your service registrations and upgrade licenses. Go to NCC to register your Zyxel Device or purchase a license.

Click **Licensing** > **Licenses** to display the following screen.

Figure 89 Licensing > Licenses (Registered)

The screenshot shows the 'Licensing > Licenses (Registered)' screen. At the top, there's a breadcrumb 'Licensing > Licenses'. Below that, the 'Registration' section displays 'Device Registration Status: Registered' in green, with a 'Refresh' button to the right. The 'Licenses Information' section features a 'Purchase Licenses' button and a search bar labeled 'Search insights'. A table lists the following services, all with a status of 'Activated' and an expiration date of '2025/09/13': Anti-Malware, Application Patrol, Device Insight, IPS, Nebula Professional Pack, Reputation Filter, Sandboxing, SecuReporter, Security Profile Sync, and Web Filtering. A note at the bottom states: '1. You must register the device to your Zyxel account; Register Zyxel Device on Nebula. 2. If you see new security services in Licensing > Licenses, make sure to upgrade to the latest firmware. Go to top right Notifications > What's New to see the latest firmware available for your model.'

The **Licenses** screen may show different services depending on the licenses you purchase or activate.

The following table describes the labels in this screen.

Table 51 Licensing > Licenses

LABEL	DESCRIPTION
Device Registration Status	This field display the Zyxel Device registration status on NCC. <ul style="list-style-type: none"> Registered: Your Zyxel Device has successfully registered at NCC. Not Registered: Your Zyxel Device is not registered at NCC. Make sure you're connected to the Internet. Wait a few minutes then click Refresh to update the registration status.
Refresh	Click this and wait for a few moments for the license and device registration status to update. The license and device registration status are updated automatically once every day.
Purchase License	Click Purchase License to go to Marketplace to renew Zyxel Device licenses.
Licenses Information	
Service	This lists the name of services or service modules that are available on the Zyxel Device.

Table 51 Licensing > Licenses (continued)

LABEL	DESCRIPTION
Anti-Malware	This is a license for cloud database signatures to detect virus patterns in files.
Application Patrol	This is a license to use signatures to manage the use of various applications on the network.
Device Insight	This is a license to detect and manage client devices in the Zyxel Device local network and DMZ.
IPS	This is a license to detect Intrusion Prevention System attacks.
Nebula Professional Pack	This is a license that allows you to use NCC to monitor and manage groups of Zyxel Devices in organizations. See the NCC User's Guide for more information on Nebula Plus and Professional pack licenses.
Priority Support	This license displays if the Gold Security Pack license for this Zyxel Device has expired. It allows you to request support for Zyxel Devices in Nebula organizations that do not have a Nebula Professional Pack license (Base-Tier).
Reputation Filter	This is a license to recognize packets coming from suspect IPv4 addresses.
Sandboxing	This is a license to provide an isolated environment to scan traffic from the WAN that comes with unknown files or untrusted programs.
SecuReporter	This is a license that allows SecuReporter to collect and analyze logs from your Zyxel Device in order to identify anomalies, notify you of potential internal or external threats, and report on network usage. SecuReporter retains logs for up to 1 year.
Security Profile Sync	Security Profile Sync is a NCC template that allows you to share the same security service settings on Firewalls in different sites in the same organization. Security service settings include Content Filter, Application Patrol, URL Threat Filter, Anti-Malware, and Intrusion Detection / Prevention.
Web Filtering	This is a license to a database that can block websites by category, such as Gambling.
Status	This field displays whether a service license is enabled at NCC (Activated) or expired (Expired). It displays the remaining grace period if your license has Expired . It displays Not Licensed if there isn't a license to be activated for this service.
Expiration Date	This field displays the date your service license expires or the date the grace period expires if the license has already expired. You can continue to use IPS, Application Patrol, Anti-Malware and Web Filtering during the grace period. After the grace period ends, all of these features are disabled.

You will see the following screen if:

- Your Zyxel Device is not registered at NCC.
- You're logging into the Zyxel Device using an admin account.

Scan the QR code or click **Nebula** under **Note** to register your Zyxel Device at NCC. Please note that you need to register your Zyxel Device at NCC to upgrade firmware and use security services.

Figure 90 Licensing > Licenses (Not Registered)

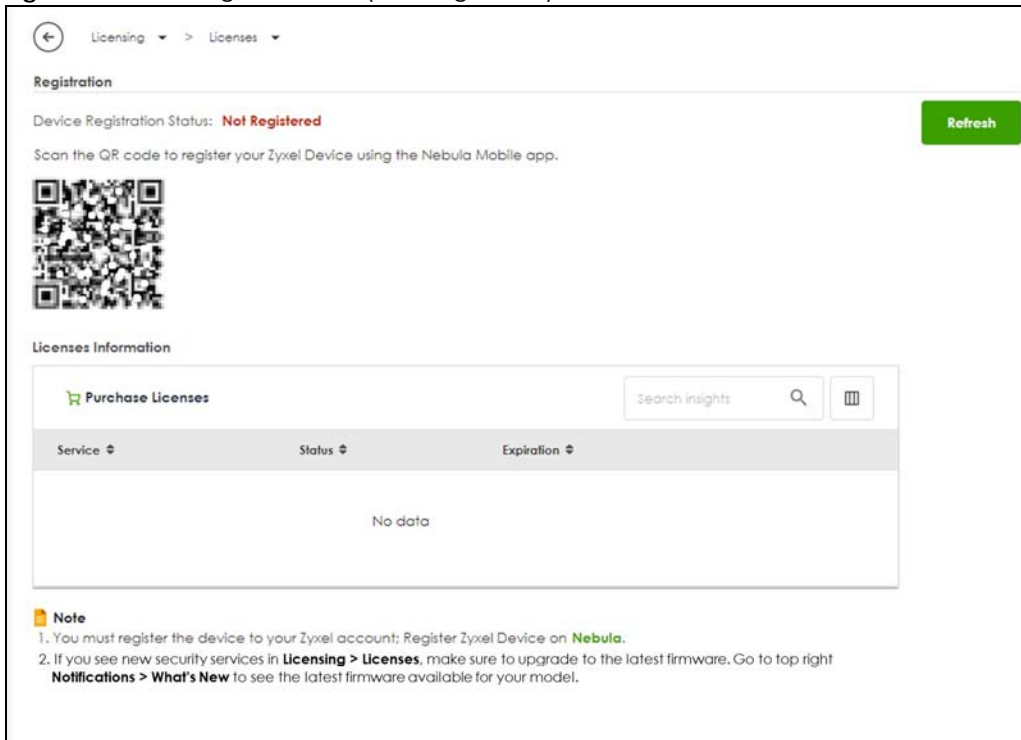

6.1.3 The Signature Update Screen

Click **Licensing > Signature Update** to display the following screen.

Figure 91 Licensing > Signature Update

The screenshot shows the 'Licensing > Signature Update' screen. It features a 'Signature' header and a 'Configuration' table. The table lists three services: APP Patrol, IPS, and IP Reputation. Each row includes columns for Feature, Type, Current Version, Release Date, Last Sync, and Action. The Action column contains refresh and delete icons. The bottom of the screen shows pagination controls: 'Rows per page: 50', '1-3 of 3', and navigation arrows.

Feature	Type	Current Version	Release Date	Last Sync	Action
APP Patrol	APP Patrol	1.0.0.20220524.0	2022/05/24 10:34:41	2022-12-12 01:18:01	Refresh Delete
IPS	IPS	4.0.0.20211116.0	2021/11/16 10:10:00	2022-12-12 01:28:01	Refresh Delete
IP Reputation	IP Reputation	1.0.0.20190101.0	2019/08/14 13:26:32	2022-12-12 01:23:01	Refresh Delete

The following table describes the labels in this screen.

Table 52 Licensing > Signature Update

LABEL	DESCRIPTION
Feature	This field displays the name of the services available on the Zyxel Device.
Type	This field displays the type of service engine used by the Zyxel Device.
Current Version	This field displays the signatures version number currently used by the Zyxel Device. This number gets larger as new signatures are added.

Table 52 Licensing > Signature Update (continued)

LABEL	DESCRIPTION
Release Date	This field displays the date and time the set was released.
Last Sync	This field displays the date and time the Zyxel Device last checked for new signatures.
Action	<p>Click the Update icon (🔄) to have the Zyxel Device immediately check for new signatures. If new signatures are found, they are then downloaded to the Zyxel Device.</p> <p>Click the Schedule icon (📅) to have the Zyxel Device automatically check for new signatures regularly at the time and day specified. You should select a time when your network is not busy for minimal interruption.</p>

6.1.4 Signature Update

Click the **Update** icon (🔄) of a service to display the following screen. Use this screen to view the service update status.

Figure 92 Licensing > Signature Update > Update > Update

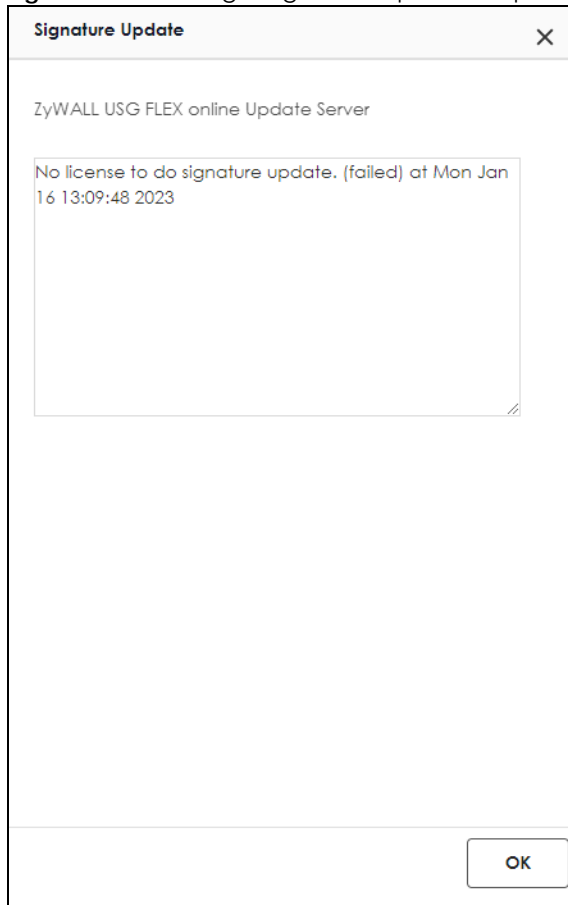

6.1.5 Auto Update

Click the **Schedule** icon (📅) of a service to display the following screen.

Figure 93 Licensing > Signature Update > Schedule > Auto Update

The following table describes the labels in this screen.

Table 53 Licensing > Signature Update > Schedule > Auto Update

LABEL	DESCRIPTION
Auto Update	Enable to have the Zyxel Device automatically check for new signatures regularly at the time and day specified. You should select a time when your network is not busy for minimal interruption.
Every N Hours	Select this option to have the Zyxel Device check for new signatures every specified (N) hour.
Daily	Select this option to have the Zyxel Device check for new signatures every day at the specified time. The time format is the 12 hour clock.
Weekly	Select this option to have the Zyxel Device check for new signatures once a week on the day and at the time specified.
OK	Click this button to save your changes to the Zyxel Device.

CHAPTER 7

Interfaces

7.1 Interface Overview

Use the **Interface** screens to configure the Zyxel Device's interfaces. You can also create interfaces on top of other interfaces.

- **Ports** are the physical ports to which you connect cables.
- **Interfaces** are used within the system operationally. You use them in configuring various features. An interface also describes a network that is directly connected to the Zyxel Device. For example, You connect the LAN network to the LAN interface.

7.1.1 What You Can Do in this Chapter

- Use the **Interface** ([Section 7.2 on page 119](#)) screen to view a summary of the Zyxel Device interface settings.
- Use the **Internal/External/General Interface** ([Section 7.3 on page 127](#)) screens to configure Ethernet, VLAN, and bridge interfaces.

Ethernet interfaces are the foundation for defining other interfaces and network policies.

VLAN interfaces receive and send tagged frames. The Zyxel Device automatically adds or removes the tags as needed.

Bridge interfaces combine two or more network segments into a single network.

- Use the **Trunk** ([Section 7.7 on page 146](#)) screen to configure load balancing.
- Use the **Port** screen ([Section 7.8 on page 150](#)) to configure Zyxel Device port settings.

7.1.2 What You Need to Know

Interface Characteristics

Interfaces generally have the following characteristics (although not all characteristics apply to each type of interface).

- An interface is a logical entity through which (layer-3) packets pass.
- An interface is bound to a physical port or another interface.
- Many interfaces can share the same physical port.
- An interface belongs to at most one zone.
- Many interfaces can belong to the same zone.

Types of Interfaces

You can create several types of interfaces in the Zyxel Device.

- Setting interfaces to the same port role forms a port group. Port groups creates a hardware connection between physical ports at the layer-2 (data link, MAC address) level. Port groups are created when you use the **Interface > Port** screen to set multiple physical ports to be part of the same interface.

Note: Some models have Individual ports. You cannot group Individual ports together or with other ports.

Table 54 Models with Individual Ports

MODEL	INDIVIDUAL PORTS
USG FLEX 500H	P1, P2
USG FLEX 700H	P1, P2, P13, P14

- **Ethernet interfaces** are the foundation for defining other interfaces and network policies.
- **VLAN interfaces** receive and send tagged frames. The Zyxel Device automatically adds or removes the tags as needed.
- **Bridge interfaces** create a software connection between Ethernet or VLAN interfaces at the layer-2 (data link, MAC address) level. Unlike port groups, bridge interfaces can take advantage of some security features in the Zyxel Device. You can also assign an IP address and subnet mask to the bridge.
- **Trunk interfaces** manage load balancing between interfaces.
- **PPPoE interfaces** support Point-to-Point Protocols (PPP). ISP accounts are required for PPPoE interfaces.
- **VPN Tunnel Interface (VTI)** encrypts or decrypts IPv4 traffic from or to the interface according to the IP routing table.

See the following table for interface types and supported features.

Table 55 Features Per Interface Type

ROLES	EXTERNAL		INTERNAL		GENERAL
Characteristics	Ethernet VLAN Bridge	PPPoE	Ethernet VLAN	Bridge	Ethernet VLAN Bridge
Configurable Zone	Yes	Yes	Yes	Yes	Yes
Static IP address	Yes	Yes	Yes	Yes	Yes
DHCP client	Yes	Yes	No	No	Yes
DHCP server/relay	No	No	Yes	Yes	Yes
Default SNAT	Yes	Yes	No	No	No
Packet size (MTU)	Yes	Yes	Yes	Yes	Yes
Connectivity Check	Yes	Yes	Yes	Yes	Yes

Relationships Between Interfaces

In the Zyxel Device, interfaces are usually created on top of other interfaces. Only Ethernet interfaces are created directly on top of the physical ports or port groups. The relationships between interfaces are explained in the following table.

Table 56 Relationships Between Different Types of Interfaces

INTERFACE	RESTRICTION	REQUIRED PORT / INTERFACE
Ethernet interface	N/A	physical port
bridge interface	When you configure a bridge interface, you cannot set the bridge interface on an interface that is already used by other bridge or VLAN interfaces.	Ethernet interface* VLAN interface*
trunk	When you configure a trunk interface, you cannot set the trunk interface on an interface that is already used by other bridge interfaces.	External/General Ethernet interface VLAN interface PPPoE interface bridge interface
PPPoE interface	N/A	Ethernet interface* VLAN interface* bridge interface

Bridge Overview

A bridge creates a connection between two or more network segments at the layer-2 (MAC address) level. In the following example, bridge X connects four network segments.

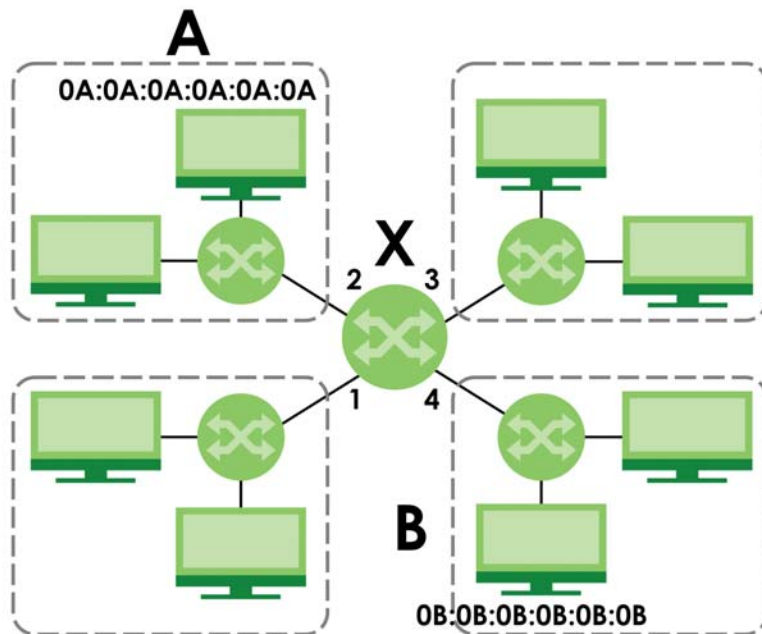

When the bridge receives a packet, the bridge records the source MAC address and the port on which it was received in a table. It also looks up the destination MAC address in the table. If the bridge knows on which port the destination MAC address is located, it sends the packet to that port. If the destination MAC address is not in the table, the bridge broadcasts the packet on every port (except the one on which it was received).

In the example above, computer A sends a packet to computer B. Bridge X records the source address 0A:0A:0A:0A:0A:0A and port 2 in the table. It also looks up 0B:0B:0B:0B:0B:0B in the table. There is no entry yet, so the bridge broadcasts the packet on ports 1, 3, and 4.

Table 57 Example: Bridge Table After Computer A Sends a Packet to Computer B

MAC ADDRESS	PORT
0A:0A:0A:0A:0A:0A	2

If computer B responds to computer A, bridge X records the source address 0B:0B:0B:0B:0B:0B and port 4 in the table. It also looks up 0A:0A:0A:0A:0A:0A in the table and sends the packet to port 2 accordingly.

Table 58 Example: Bridge Table After Computer B Responds to Computer A

MAC ADDRESS	PORT
0A:0A:0A:0A:0A:0A	2
0B:0B:0B:0B:0B:0B	4

Bridge Interface Overview

A bridge interface creates a software bridge between the members of the bridge interface. It also becomes the Zyxel Device's interface for the resulting network.

The Zyxel Device can bridge traffic between some interfaces while it routes traffic for other interfaces. The bridge interfaces also support functions like interface bandwidth parameters, DHCP settings, and connectivity check. To use the whole Zyxel Device as a transparent bridge, add all of the Zyxel Device's interfaces to a bridge interface.

A bridge interface may consist of the following members:

- Zero or one VLAN interfaces (and any associated virtual VLAN interfaces)
- Any number of Ethernet interfaces (and any associated virtual Ethernet interfaces)

When you create a bridge interface, the Zyxel Device removes the members' entries from the routing table and adds the bridge interface's entries to the routing table. For example, this table shows the routing table before and after you create bridge interface br0 (250.250.250.0/23) between lan1 and vlan1.

Table 59 Example: Routing Table Before and After Bridge Interface br0 Is Created

IP ADDRESS(ES)	DESTINATION	IP ADDRESS(ES)	DESTINATION
210.210.210.0/24	lan1	221.221.221.0/24	vlan0
210.211.1.0/24	lan1:1	230.230.230.192/26	wan2
221.221.221.0/24	vlan0	241.241.241.241/32	dmz
222.222.222.0/24	vlan1	242.242.242.242/32	dmz
230.230.230.192/26	wan2	250.250.250.0/23	br0
241.241.241.241/32	dmz		
242.242.242.242/32	dmz		

In this example, virtual Ethernet interface lan1:1 is also removed from the routing table when lan1 is added to br0. Virtual interfaces are automatically added to or removed from a bridge interface when the underlying interface is added or removed.

IP Address Assignment

Most interfaces have an IP address and a subnet mask.

Figure 94 Example: Entry in the Routing Table Derived from Interfaces



This information is used to create an entry in the routing table.

Table 60 Example: Routing Table Entries for Interfaces

IP ADDRESS(ES)	DESTINATION
100.100.1.1/16	lan1
200.200.200.1/24	wan1

For example, if the Zyxel Device gets a packet with a destination address of 100.100.25.25, it routes the packet to interface lan1. If the Zyxel Device gets a packet with a destination address of 200.200.200.200, it routes the packet to interface wan1.

In most interfaces, you can enter the IP address and subnet mask manually. In PPPoE interfaces, however, the subnet mask is always 255.255.255.255 because it is a point-to-point interface. For these interfaces, you can only enter the IP address.

In many interfaces, you can also let the IP address and subnet mask be assigned by an external DHCP server on the network. In this case, the interface is a DHCP client. Virtual interfaces, however, cannot be DHCP clients. You have to assign the IP address and subnet mask manually.

In general, the IP address and subnet mask of each interface should not overlap, though it is possible for this to happen with DHCP clients.

In the example above, if the Zyxel Device gets a packet with a destination address of 5.5.5.5, it might not find any entries in the routing table. In this case, the packet is dropped. However, if there is a default router to which the Zyxel Device should send this packet, you can specify it as a gateway in one of the interfaces. For example, if there is a default router at 200.200.200.100, you can create a gateway at 200.200.200.100 on ge2. In this case, the Zyxel Device creates the following entry in the routing table.

Table 61 Example: Routing Table Entry for a Gateway

IP ADDRESS(ES)	DESTINATION
0.0.0.0/0	200.200.200.100

The gateway is an optional setting for each interface. If there is more than one gateway, the Zyxel Device uses the gateway with the lowest metric, or cost. If two or more gateways have the same metric, the Zyxel Device uses the one that was set up first (the first entry in the routing table). In PPPoE interfaces, the other computer is the gateway for the interface by default. In this case, you should specify the metric.

If the interface gets its IP address and subnet mask from a DHCP server, the DHCP server also specifies the gateway, if any.

DHCP Settings

Dynamic Host Configuration Protocol (DHCP, RFC 2131, RFC 2132) provides a way to automatically set up and maintain IP addresses, subnet masks, gateways, and some network information (such as the IP addresses of DNS servers) on computers on the network. This reduces the amount of manual configuration you have to do and usually uses available IP addresses more efficiently.

In DHCP, every network has at least one DHCP server. When a computer (a DHCP client) joins the network, it submits a DHCP request. The DHCP servers get the request; assign an IP address; and provide the IP address, subnet mask, gateway, and available network information to the DHCP client. When the DHCP client leaves the network, the DHCP servers can assign its IP address to another DHCP client.

In the Zyxel Device, some interfaces can provide DHCP services to the network. In this case, the interface can be a DHCP relay or a DHCP server.

As a DHCP relay, the interface routes DHCP requests to DHCP servers on different networks. You can specify more than one DHCP server. If you do, the interface routes DHCP requests to all of them. It is possible for an interface to be a DHCP relay and a DHCP client simultaneously.

As a DHCP server, the interface provides the following information to DHCP clients.

- IP address - If the DHCP client's MAC address is in the Zyxel Device's static DHCP table, the interface assigns the corresponding IP address. If not, the interface assigns IP addresses from a pool, defined by the starting address of the pool and the pool size.

Table 62 Example: Assigning IP Addresses from a Pool

START IP ADDRESS	POOL SIZE	RANGE OF ASSIGNED IP ADDRESS
50.50.50.33	5	50.50.50.33 - 50.50.50.37
75.75.75.1	200	75.75.75.1 - 75.75.75.200
99.99.1.1	1023	99.99.1.1 - 99.99.4.255
120.120.120.100	100	120.120.120.100 - 120.120.120.199

The Zyxel Device cannot assign the first address (network address) or the last address (broadcast address) on the subnet defined by the interface's IP address and subnet mask. For example, in the first entry, if the subnet mask is 255.255.255.0, the Zyxel Device cannot assign 50.50.50.0 or 50.50.50.255. If the subnet mask is 255.255.0.0, the Zyxel Device cannot assign 50.50.0.0 or 50.50.255.255. Otherwise, it can assign every IP address in the range, except the interface's IP address.

If you do not specify the starting address or the pool size, the interface the maximum range of IP addresses allowed by the interface's IP address and subnet mask. For example, if the interface's IP address is 9.9.9.1 and subnet mask is 255.255.255.0, the starting IP address in the pool is 9.9.9.2, and the pool size is 253.

- Subnet mask - The interface provides the same subnet mask you specify for the interface. See [IP Address Assignment on page 115](#).
- Gateway - The interface provides the same gateway you specify for the interface. See [IP Address Assignment on page 115](#).
- DNS servers - The interface provides IP addresses for up to three DNS servers that provide DNS services for DHCP clients. You can specify each IP address manually (for example, a company's own DNS server), or you can refer to DNS servers that other interfaces received from DHCP servers (for example, a DNS server at an ISP). These other interfaces have to be DHCP clients.

It is not possible for an interface to be the DHCP server and a DHCP client simultaneously.

WINS

WINS (Windows Internet Naming Service) is a Windows implementation of NetBIOS Name Server (NBNS) on Windows. It keeps track of NetBIOS computer names. It stores a mapping table of your network's computer names and IP addresses. The table is dynamically updated for IP addresses assigned by DHCP. This helps reduce broadcast traffic since computers can query the server instead of broadcasting a request for a computer name's IP address. In this way WINS is similar to DNS, although WINS does not use a hierarchy (unlike DNS). A network can have more than one WINS server. Samba can also serve as a WINS server.

PPPoE Overview

Point-to-Point Protocol over Ethernet (PPPoE, RFC 2516) is usually used to connect two computers over phone lines or broadband connections. PPPoE is often used with cable modems and DSL connections. It provides the following advantages:

- The access and authentication method works with existing systems, including RADIUS.
- You can access one of several network services. This makes it easier for the service provider to offer the service
- PPPoE does not usually require any special configuration of the modem.

Introduction to VLANs

A Virtual Local Area Network (VLAN) divides a physical network into multiple logical networks. The standard is defined in IEEE 802.1q.

Figure 95 Example: Before VLAN

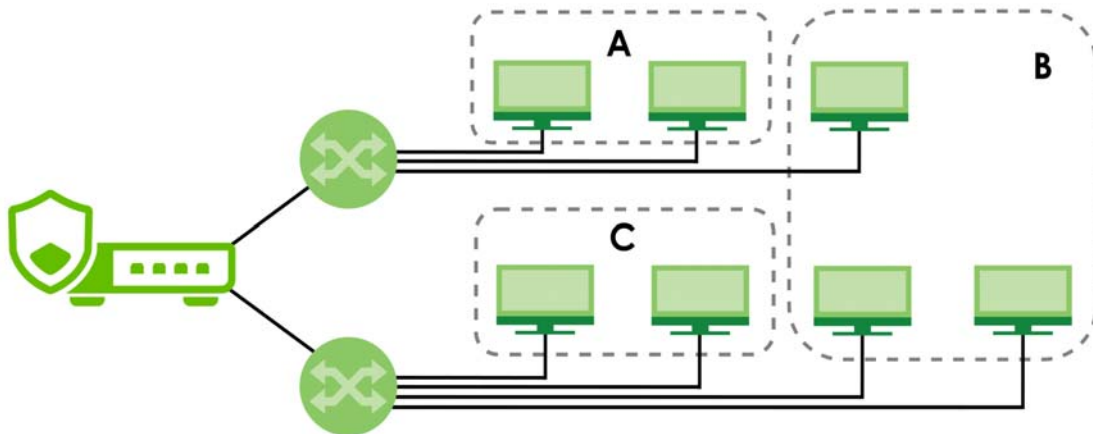

In this example, there are two physical networks and three departments **A**, **B**, and **C**. The physical networks are connected to hubs, and the hubs are connected to the router.

Alternatively, you can divide the physical networks into three VLANs.

Figure 96 Example: After VLAN

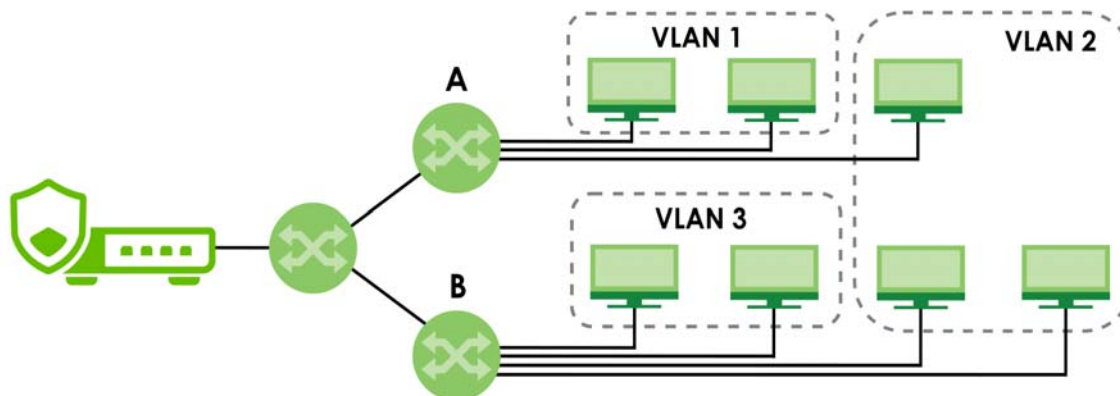

Each VLAN is a separate network with separate IP addresses, subnet masks, and gateways. Each VLAN also has a unique identification number (ID). The ID is a 12-bit value that is stored in the MAC header. The VLANs are connected to switches, and the switches are connected to the router. (If one switch has enough connections for the entire network, the network does not need switches **A** and **B**.)

- Traffic inside each VLAN is layer-2 communication (data link layer, MAC addresses). It is handled by the switches. As a result, the new switch is required to handle traffic inside VLAN 2. Traffic is only broadcast inside each VLAN, not each physical network.
- Traffic between VLANs (or between a VLAN and another type of network) is layer-3 communication (network layer, IP addresses). It is handled by the router.

This approach provides a few advantages.

- Increased performance - In VLAN 2, the extra switch should route traffic inside the sales department faster than the router does. In addition, broadcasts are limited to smaller, more logical groups of users.
- Higher security - If each computer has a separate physical connection to the switch, then broadcast traffic in each VLAN is never sent to computers in another VLAN.
- Better manageability - You can align network policies more appropriately for users. For example, you can create different content filtering rules for each VLAN (each department in the example above), and you can set different bandwidth limits for each VLAN. These rules are also independent of the physical network, so you can change the physical network without changing policies.

In this example, the new switch handles the following types of traffic:

- Inside VLAN 2.
- Between the router and VLAN 1.
- Between the router and VLAN 2.
- Between the router and VLAN 3.

In the Zyxel Device, each VLAN is called a VLAN interface. As a router, the Zyxel Device routes traffic between VLAN interfaces, but it does not route traffic within a VLAN interface. All traffic for each VLAN interface can go through only one Ethernet interface, though each Ethernet interface can have one or more VLAN interfaces.

Note: Each VLAN interface is created on top of only one Ethernet interface.

Otherwise, VLAN interfaces are similar to other interfaces in many ways. They have an IP address, subnet mask, and gateway used to make routing decisions. They restrict bandwidth and packet size. They can provide DHCP services, and they can verify the gateway is available.

7.2 Interface Screen

Use this screen to view your Zyxel Device interface settings. To access this screen, click **Network > Interface > Interface**.

Add an interface to which type of network you will connect. When you select **Internal**, **External** or **General**, the rest of the screen's options automatically adjust to correspond.

- The **External** interface is for connecting to an external network (like the Internet). The Zyxel Device automatically adds this interface to the default WAN trunk.
- The **Internal** interface is for connecting to a local network. Other corresponding configuration options: DHCP server and DHCP relay. The Zyxel Device automatically adds default SNAT settings for traffic flowing from this interface to an external interface; for example LAN to WAN traffic.
- The **General** interface is for connecting to either an external network or a local network. Select this option when you want full flexibility to manually define specific routing, NAT, or security rules without the automatic settings applied to **Internal** or **External** interfaces.

7.2.1 Interface Screen Warning Messages

Nebula VPN allows Zyxel Devices from different sites in an organization to communicate through a VPN.

The following reminder appears on the the **Network > Interface > Interface** screen if Nebula VPN is enabled. If you change IP addresses locally, there may be a conflict that would impact Nebula VPN.

i Nebula VPN is Active. This device is currently managed by the Nebula Control Center. Any changes made locally may impact VPN connectivity and configuration.

The following warning appears if Nebula VPN is enabled and you are removing an interface. This may disrupt Nebula VPN. Ensure your Zyxel Device's local IP address and network mask are different from those used by local networks behind other Zyxel Devices participating in Nebula VPN.

Figure 97 Subnet Change Warning

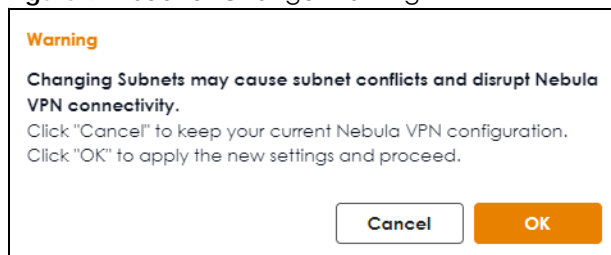

The following warning appears if Nebula VPN is enabled and you are removing an interface. This may disrupt Nebula VPN. Ensure you do not remove a subnet interface that is participating in the organization's VPN in the NCC.

Figure 98 Interface Removal Warning

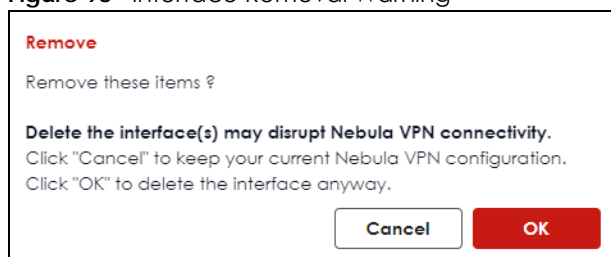
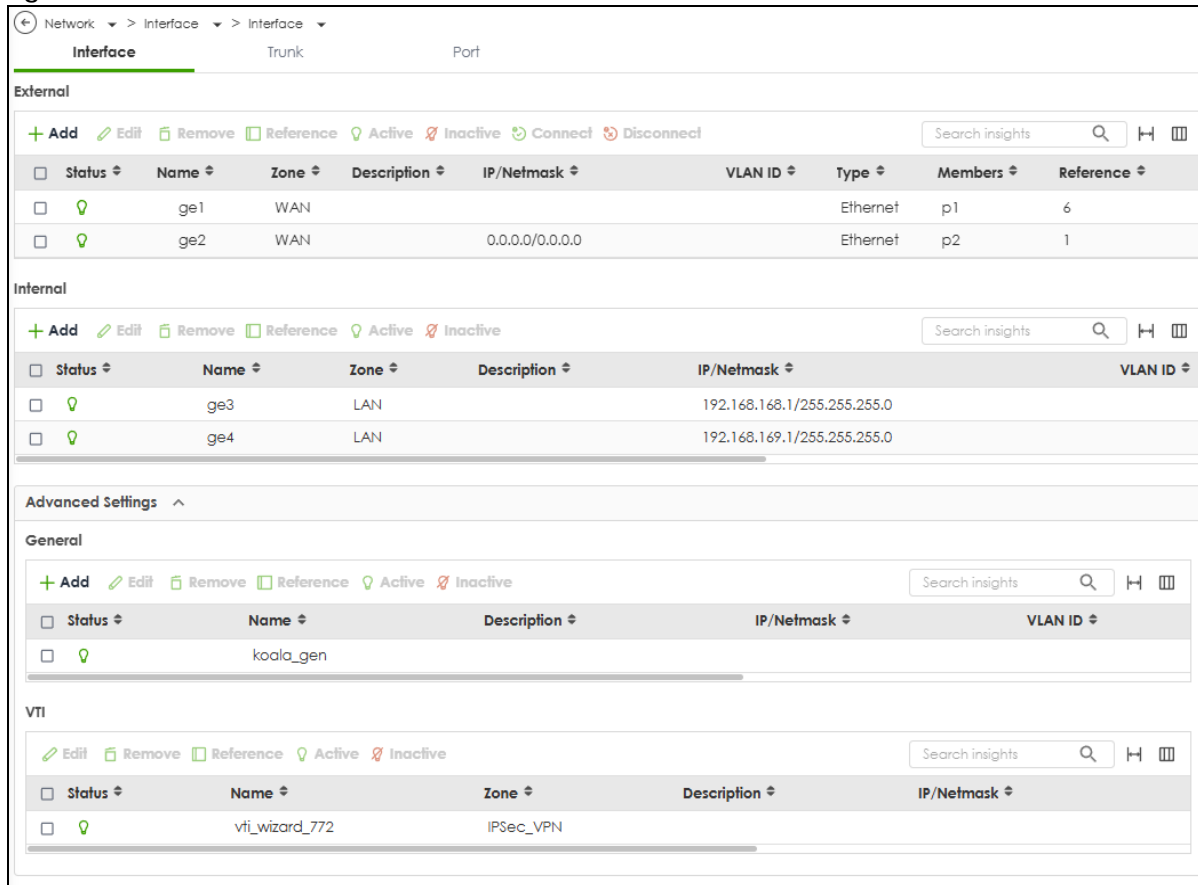

Figure 99 Network > Interface > Interface



Each field is described in the following table.

Table 63 Network > Interface > Interface

LABEL	DESCRIPTION
External	
Add	Click this to add a new entry.
Edit	Select an entry and click Edit to open a screen where you can modify the entry's settings.
Remove	To remove a virtual interface, select it and click Remove . The Zyxel Device confirms you want to remove it before doing so.
Reference	This field displays the objects this entry uses.
Active	To turn on an entry, select it and click Active . The Status light changes accordingly.
Inactive	To turn off an entry, select it and click Inactive . The Status light changes accordingly.
Connect	To dial-up to a PPPoE interface, select it and click Connect .
Disconnect	To disconnect from a PPPoE interface, select it and click Disconnect .
Status	This icon is lit when the entry is active and dimmed when the entry is inactive.
Name	This field displays the name of the interface.
Zone	This displays the zone to which this interface belongs. An interface can only be in one zone.
Description	This field displays the description of the interface.
IP/Netmask	This field displays the current IP address and the subnet mask of the interface. If this field is empty, the interface does not have an IP address yet.
VLAN ID	This field displays the VLAN ID which is a 12-bit number that uniquely identifies each VLAN.

Table 63 Network > Interface > Interface (continued)

LABEL	DESCRIPTION
Type	This field displays the interface type: Ethernet or VLAN.
Ports	This field displays the port the interface is using.
Reference	This field displays how many objects this entry uses.
Internal	
Add	Click this to add a new entry.
Edit	Select an entry and click Edit to open a screen where you can modify the entry's settings.
Remove	To remove a virtual interface, select it and click Remove . The Zyxel Device confirms you want to remove it before doing so.
Reference	This field displays the objects this entry uses.
Active	To turn on an entry, select it and click Active . The Status light changes accordingly.
Inactive	To turn off an entry, select it and click Inactive . The Status light changes accordingly.
Status	This icon is lit when the entry is active and dimmed when the entry is inactive.
Name	This field displays the name of the interface.
Zone	This displays the zone to which this interface belongs. An interface can only be in one zone.
Description	This field displays the description of the interface.
IP/Netmask	This field displays the current IP address and the subnet mask of the interface. If this field is empty, the interface does not have an IP address yet.
VLAN ID	This field displays the VLAN ID which is a 12-bit number that uniquely identifies each VLAN.
Type	This field displays the interface type.
Members	This field displays the port the interface is using.
Reference	This field displays how many objects this entry uses.
Advanced Settings	
General	
Add	Click this to add a new entry.
Edit	Select an entry and click Edit to open a screen where you can modify the entry's settings.
Remove	To remove a general interface, select it and click Remove . The Zyxel Device confirms you want to remove it before doing so.
Reference	This field displays the objects this entry uses.
Active	To turn on an entry, select it and click Active . The Status light changes accordingly.
Inactive	To turn off an entry, select it and click Inactive . The Status light changes accordingly.
Status	This icon is lit when the entry is active and dimmed when the entry is inactive.
Name	This field displays the name of the interface.
Zone	This displays the zone to which this interface belongs. An interface can only be in one zone.
Description	This field displays the description of the interface.
IP/Netmask	This field displays the current IP address and the subnet mask of the interface. If this field is empty, the interface does not have an IP address yet.
VLAN ID	This field displays the VLAN ID which is a 12-bit number that uniquely identifies each VLAN.
Type	This field displays the interface type.
Members	This field displays the Ethernet interfaces and VLAN interfaces in the bridge interface. It is blank for virtual interfaces.
Reference	This field displays how many objects this entry uses.
VTI	
Edit	Select an entry and click Edit to open a screen where you can modify the entry's settings.

Table 63 Network > Interface > Interface (continued)

LABEL	DESCRIPTION
Remove	To remove a virtual interface, select it and click Remove . The Zyxel Device confirms you want to remove it before doing so.
Reference	This field displays the objects this entry uses.
Active	To turn on an entry, select it and click Active . The Status light changes accordingly.
Inactive	To turn off an entry, select it and click Inactive . The Status light changes accordingly.
Status	This icon is lit when the entry is active and dimmed when the entry is inactive.
Name	This field displays the name of the interface.
Zone	This displays the zone to which this interface belongs. An interface can only be in one zone.

Use this screen to configure the external interface settings for connecting to an external network (like the Internet). The Zyxel Device automatically adds an external interface to the default WAN trunk.

7.2.2 External Interface Add/Edit

Unlike other types of interfaces, you cannot create new Ethernet interfaces nor can you delete any of them. If an Ethernet interface does not have any physical ports assigned to it, the Ethernet interface is effectively removed from the Zyxel Device, but you can still configure it.

Ethernet interfaces are similar to other types of interfaces in many ways. They have an IP address, subnet mask, and gateway used to make routing decisions. They restrict the amount of bandwidth and packet size. They can provide DHCP services, and they can verify the gateway is available.

Use Ethernet interfaces to control which physical ports exchange routing information with other routers and how much information is exchanged through each one. The more routing information is exchanged, the more efficient the routers should be. However, the routers also generate more network traffic, and some routing protocols require a significant amount of configuration and management.

Figure 100 Network > Interface > Interface > External > Add (General)

Network > Interface > Interface > External > Add (General)

General Settings

Enable Interface

Interface Properties

Role: external

Interface Type: Ethernet

Name:
! The value in this field is invalid. It cannot exceed 11 characters. The valid characters are [a-z][A-Z][0-9][a-z][A-Z][_].

Port:
! This field is required.

Zone: WAN

MAC Address: Use Default MAC Address
 Overwrite Default MAC Address

Description:

Address Assignment: Unassigned
 Get Automatically (DHCP)
 Use Fixed IP Address

PPPoE

Figure 101 Network > Interface > Interface > External > Add (PPPoE Add)

Add PPPoE

Authentication Type: PAP

User Name:
! Use up to 64 single-byte characters, including 0-9a-zA-Z-@\$. /+ # ; :%~^&*() = {} | ? , < ' >. The user name must begin with 0-9a-zA-Z-@\$. /+

Password:
! Please enter your password.

Retype:
! This field is required.

Service Name:

Compression: On Off

User Idle Timeout: (0-360 seconds)

WAN IP:

Gateway IP:

Figure 102 Network > Interface > Interface > External > Add (Connectivity Check & Advanced)

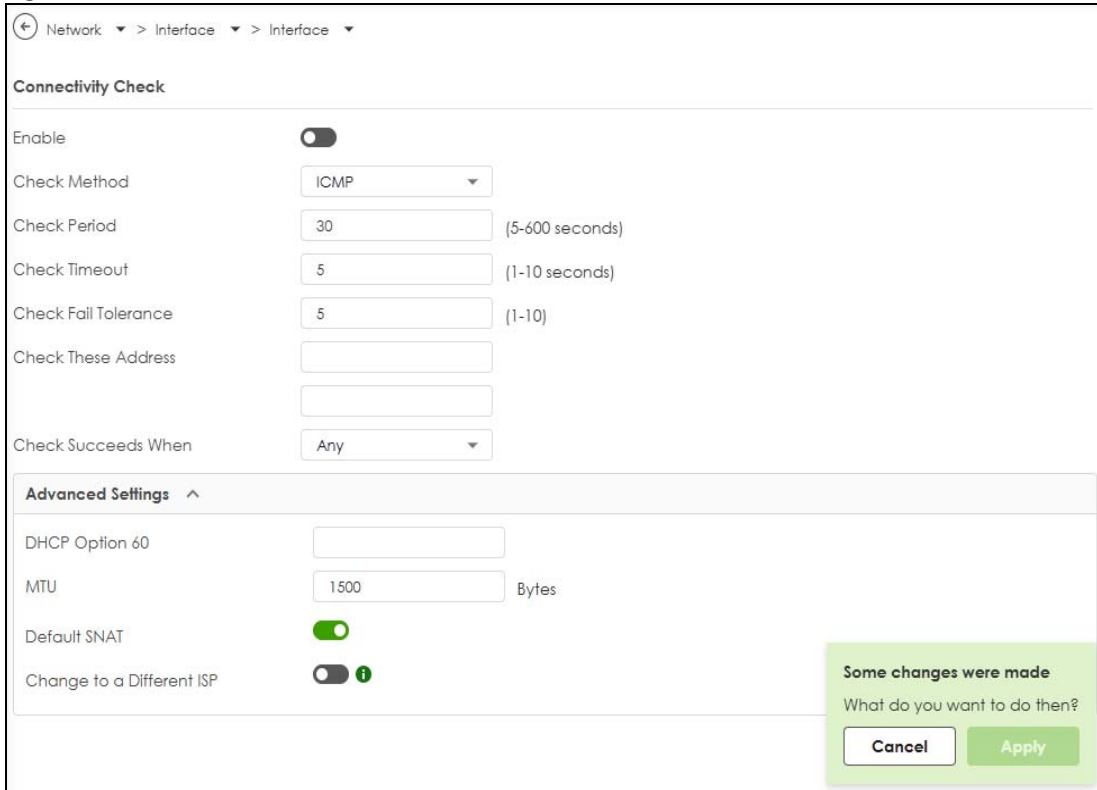

These screen's fields are described in the table below.

Table 64 Network > Interface > Interface > External > Add/Edit

LABEL	DESCRIPTION
General Settings	
Enable Interface	Select this to enable this interface. Clear this to disable this interface.
Interface Properties	
Role	External is for connecting to an external network (like the Internet). The Zyxel Device automatically adds this interface to the default WAN trunk.
Interface Type	Select the type of interface you want to configure. Select Ethernet to establish the foundation for defining other interfaces and network policies. Select VLAN to receive and send tagged frames. The Zyxel Device automatically adds or removes the tags as needed. Select Bridge to create a single network between Ethernet or VLAN interfaces at the layer-2 (data link, MAC address) level. Unlike port groups, bridge interfaces can take advantage of some security features in the Zyxel Device, such as Policy Control and IP Exception. You can also assign an IP address and subnet mask to the bridge.
Name	Specify a name for the interface. It can use alphanumeric characters, hyphens, and underscores, and it can be up to 11 characters long.
Port	This is the name of the Ethernet interface's physical port.
Zone	Select the zone to which this interface is to belong. You use zones to apply security settings such as security policy, IPS, remote management, anti-malware, and application patrol. Make sure to select the correct zone as otherwise traffic may be blocked by a security policy.

Table 64 Network > Interface > Interface > External > Add/Edit

LABEL	DESCRIPTION
MAC Address	Have the interface use either the factory assigned default MAC address, a manually specified MAC address, or clone the MAC address of another device or computer.
Use Default MAC Address	Select this option to have the interface use the factory assigned default MAC address. By default, the Zyxel Device uses the factory assigned MAC address to identify itself.
Overwrite Default MAC Address	Select this option to have the interface use a different MAC address. Enter a MAC address in the format "xx:xx:xx:xx:xx:xx" or "xx-xx-xx-xx-xx-xx". Once it is successfully configured, the address will be copied to the configuration file. It will not change unless you change the setting or upload a different configuration file.
VLAN ID	This field displays when you select the VLAN Interface Type . Enter the VLAN ID. This 12-bit number uniquely identifies each VLAN. Allowed values are 1 - 4094. (0 and 4095 are reserved.)
Priority (802.1P)	This field displays when you select the VLAN Interface Type . Type a number between 0 and 7 to set the priority for the outgoing traffic from this interface. The bigger the number, the higher the priority.
Description	Enter a description of this interface. You can use alphanumeric and () + / : = ? ! * # @ \$ _ % - characters, and it can be up to 60 characters long. Spaces are allowed, but the string can't start with a space.
Address Assignment	These IP address fields configure an IPv4 IP address on the interface itself. If you change this IP address on the interface, you may also need to change a related address object for the network connected to the interface. For example, if you use this screen to change the IP address of your LAN interface, you should also change the corresponding LAN subnet address object.
Unassigned	Select this if you don't want to specify an IP address for this interface.
Get Automatically (DHCP)	Select this to make the interface a DHCP client and automatically get the IP address, subnet mask, and gateway address from a DHCP server.
Use Fixed IP Address	Select this if you want to specify the IP address, subnet mask, and gateway manually. <ul style="list-style-type: none"> • IP/Network Mask: You must enter the primary IP address to identify the WAN interface's address for sending traffic with other network devices. • Gateway IP: Enter the IP address of the router through which this WAN connection will send traffic.
Secondary IP	This is available when you select Use Fixed IP Address . An interface can be bound to three additional public IP addresses. You can assign these IP addresses to different servers on the same interface, enabling the servers to receive traffic using different IP addresses and ports.
Add	Click this to bind up to three additional IP addresses to this interface.
Remove	To remove a secondary IP address, select it and click Remove . The Zyxel Device confirms you want to remove it before doing so. Note: Ensure the secondary IP is address not being used by any service before removing it; otherwise, or the Zyxel Device might be unable to use the service.
IP/Netmask	Enter the secondary IP address and subnet mask to bind to this interface.
Members	This is available when you select Bridge interface type.
Add	Click this to add a new interface. You can add up to eight interfaces to per bridge interface.
Remove	To remove an interface from the bridge interface, select it and click Remove . The Zyxel Device confirms you want to remove it before doing so.

Table 64 Network > Interface > Interface > External > Add/Edit

LABEL	DESCRIPTION
Members	<p>Select an Ethernet interface or VLAN interface to add it to the bridge interface. An interface is not available in the following situations:</p> <ul style="list-style-type: none"> • There is a virtual interface on top of it • It is already used in a different bridge interface • Each bridge interface can only have one VLAN interface.
Zone	<p>Select the zone to which this interface is to belong. You use zones to apply security settings such as security policy, IPS, remote management, anti-malware, and application patrol. Make sure to select the correct zone as otherwise traffic may be blocked by a security policy.</p>
PPPoE	<p>Select this for a dial-up connection according to the information from your ISP. The following fields appear in the Add PPPoE screen.</p>
Authentication Type	<p>Select an authentication protocol for outgoing connection requests.</p> <ul style="list-style-type: none"> • Chap: Your Zyxel Device accepts CHAP only. • PAP: Your Zyxel Device accepts PAP only. • MSCHAP: Your Zyxel Device accepts MSCHAP only. • MSCHAP-V2: Your Zyxel Device accepts MSCHAP-V2 only.
User Name	<p>Enter the user name give to you by your ISP. You can use up to 30 single-byte characters, including 0-9a-zA-Z@._-</p>
Password	<p>Enter the password associated with the user name. You can use 4 to 63 single-byte characters, including 0-9a-zA-Z'(){}<>^'+/!*#@&=\$\.%~ ;-'</p>
Retype	<p>Retype the password you entered in the Password field to confirm.</p>
Service Name	<p>Enter the service name from your service provider. PPPoE uses a service name to identify and reach the PPPoE server. You can use up to 30 single-byte characters, including 0-9a-zA-Z._-</p>
Compression	<p>Select On to turn on stac compression. Select Off to turn of stac compression. Stac compression is data compression technique capable of compressing data by a factor of about four.</p>
User Idle Timeout	<p>Enter the idle timeout in seconds that elapses before the router automatically disconnects from the PPPoE server.</p>
WAN IP	<p>Enter the IP address of the WAN interface through which this connection will send traffic.</p>
Gateway IP	<p>Enter the IP address of the router through which this WAN connection will send traffic.</p>
Connectivity Check	<p>The interface can regularly check the connection to the gateway you specified to make sure it is still available. You specify how often the interface checks the connection, how long to wait for a response before the attempt is a failure, and how many consecutive failures are required before the Zyxel Device stops routing to the gateway. The Zyxel Device resumes routing to the gateway the first time the gateway passes the connectivity check.</p>
Enable	<p>Select this to turn on the connection check.</p>
Check Method	<p>Select the method that the gateway allows.</p> <p>Select ICMP to have the Zyxel Device regularly ping the gateway you specify to make sure it is still available.</p> <p>Select TCP to have the Zyxel Device regularly perform a TCP handshake with the gateway you specify to make sure it is still available.</p>
Check Period	<p>Enter the number of seconds between connection check attempts.</p>
Check Timeout	<p>Enter the number of seconds to wait for a response before the attempt is a failure.</p>
Check Fail Tolerance	<p>Enter the number of consecutive failures before the Zyxel Device stops routing through the gateway.</p>

Table 64 Network > Interface > Interface > External > Add/Edit

LABEL	DESCRIPTION
Check These Addresses	Specify one or two domain names or IP addresses for the connectivity check. You can type an IPv4 address in one field and a domain name in the other. For example, type "192.168.1.2" in the top field and "www.zyxel.com" in the bottom field.
Check Succeeds When	This field applies when you specify two domain names or IP addresses for the connectivity check. Select Any if you want the check to pass if at least one of the domain names or IP addresses responds. Select All if you want the check to pass only if both domain names or IP addresses respond.
Advanced Settings	
DHCP Option 60	This field appears when Role is set to External . The setting you configure here will only work when Address Assignment is set to Get Automatically . DHCP Option 60 is used by the Zyxel Device for identification to the DHCP server using the VCI (Vendor Class Identifier) on the DHCP server. The Zyxel Device adds it in the initial DHCP discovery message that a DHCP client broadcasts in search of an IP address. The DHCP server can assign different IP addresses or options to clients with the specific VCI or reject the request from clients without the specific VCI. Type a string using up to 63 of these characters [a-zA-Z0-9!\\"#\$%&\'()*+,-./:;<=>?@[\\]^_`{}]
MTU	This is the Maximum Transmission Unit. Type the maximum size of each data packet, in bytes, that can move through this interface. If a larger packet arrives, the Zyxel Device divides it into smaller fragments. Allowed values are 1280-1500. Usually, this value is 1500.
Default SNAT	This field appears when Role is set to External . Select this to have the Zyxel Device use the IP address of the outgoing interface as the source IP address of the packets it sends out through its WAN trunks. The Zyxel Device automatically adds SNAT settings for traffic it routes from internal interfaces to external interfaces.
Change to a Different ISP	If the Zyxel Device disconnects from the Nebula Control Center, it will revert to the previous configuration. If you select this option, the Zyxel Device will not revert to the previous configuration when it loses connection to the NCC due to an ISP change.
Apply	Click Apply to save your changes back to the Zyxel Device.
Cancel	Click Cancel to return the screen to its last-saved settings.

7.3 Internal Interface

Use this screen to configure the internal interface settings for connecting to a local network. Other corresponding configuration options are DHCP server and DHCP relay. The Zyxel Device automatically applies the default SNAT settings to traffic flowing from an internal interface to an external interface.

7.3.1 Internal Interface Add/Edit

Unlike other types of interfaces, you cannot create new Ethernet interfaces nor can you delete any of them. If an Ethernet interface does not have any physical ports assigned to it, the Ethernet interface is effectively removed from the Zyxel Device, but you can still configure it.

Ethernet interfaces are similar to other types of interfaces in many ways. They have an IP address, subnet mask, and gateway used to make routing decisions. They restrict the amount of bandwidth and packet size. They can provide DHCP services, and they can verify the gateway is available.

Use Ethernet interfaces to control which physical ports exchange routing information with other routers and how much information is exchanged through each one. The more routing information is exchanged, the more efficient the routers should be. However, the routers also generate more network traffic, and some routing protocols require a significant amount of configuration and management.

Figure 103 Network > Interface > Interface > Internal > Add /Edit (Ethernet)

Network > Interface > Interface > Internal > Add /Edit (Ethernet)

General Settings

Enable Interface

Interface Properties

Role: internal

Interface Type: Ethernet

Name:

Port:

Zone: LAN

MAC Address: Use Default MAC Address
 Overwrite Default MAC Address

Description:

Address Assignment: Unassigned Use Fixed IP Address

IP/Network Mask:

Secondary IP:

DHCP Server

Enable:

Mode: DHCP

Start IP: 255.255.255.0 Pool Size: 200

First DNS Server: ZyWALL

Second DNS Server: None

Third DNS Server: None

First WINS Server (Optional):

Second WINS Server (Optional):

Default Router: Interface IP

Lease Time: 2 days hours minutes

Static DHCP Table

Additional DHCP options

DHCP Extended Options

Name	Code	Type
No data		

PXE Server:

PXE Boot Loader File:

Advanced Settings

Connectivity Check

Enable:

Check Method: ICMP

Check Period: 30 (5-600 seconds)

Check Timeout: 5 (1-10 seconds)

Check Fail Tolerance: 5 (1-10)

Check These Address:

Check Succeeds When: Any

Interface Parameter

MTU: 1500 Bytes

Some changes were made
What do you want to do then?
Cancel Apply

These screen's fields are described in the table below.

Table 65 Network > Interface > Interface > Internal > Add/Edit

LABEL	DESCRIPTION
General Settings	
Enable Interface	Select this to enable this interface. Clear this to disable this interface.
Interface Properties	
Role	Internal is for connecting to a local network. Other corresponding configuration options: DHCP server and DHCP relay. The Zyxel Device automatically adds default SNAT settings for traffic flowing from this interface to an external interface; for example LAN to WAN traffic.
Interface Type	Select the type of interface you want to configure. Select Ethernet to establish the foundation for defining other interfaces and network policies. Select VLAN to receive and send tagged frames. The Zyxel Device automatically adds or removes the tags as needed. Select Bridge to create a single network between Ethernet or VLAN interfaces at the layer-2 (data link, MAC address) level. Unlike port groups, bridge interfaces can take advantage of some security features in the Zyxel Device, such as Policy Control and IP Exception. You can also assign an IP address and subnet mask to the bridge.
Name	Specify a name for the interface. It can use alphanumeric characters, hyphens, and underscores, and it can be up to 11 characters long.
Port	This is the name of the Ethernet interface's physical port.
Zone	Select the zone to which this interface is to belong. You use zones to apply security settings such as security policy, IPS, remote management, anti-malware, and application patrol. Make sure to select the correct zone as otherwise traffic may be blocked by a security policy.
MAC Address	This field is read-only. This is the MAC address that the Ethernet interface uses.
Description	Enter a description of this interface. You can use alphanumeric and () + / : = ? ! * # @ \$ _ % - characters, and it can be up to 60 characters long. Spaces are allowed, but the string can't start with a space.
Address Assignment	These IP address fields configure an IPv4 IP address on the interface itself. If you change this IP address on the interface, you may also need to change a related address object for the network connected to the interface. For example, if you use this screen to change the IP address of your LAN interface, you should also change the corresponding LAN subnet address object.
Unassigned	Select this if you don't want to specify an IP address for this interface.
Use Fixed IP Address	Select this if you want to specify the IP address and subnet mask manually.
Secondary IP	This is available when you select Use Fixed IP Address . An interface can be bound to three additional public IP addresses. You can assign these IP addresses to different servers on the same interface, enabling the servers to receive traffic using different IP addresses and ports.
Add	Click this to bind up to three additional IP addresses to this interface.
Remove	To remove a secondary IP address, select it and click Remove . The Zyxel Device confirms you want to remove it before doing so. Note: Ensure the secondary IP is address not being used by any service before removing it; otherwise, or the Zyxel Device might be unable to use the service.
IP/Netmask	Enter the secondary IP address and subnet mask to bind to this interface.
Members	This is available when you select Bridge interface type.
Add	Click this to add a new interface. You can add up to eight interfaces to per bridge interface.

Table 65 Network > Interface > Interface > Internal > Add/Edit (continued)

LABEL	DESCRIPTION
Remove	To remove an interface from the bridge interface, select it and click Remove . The Zyxel Device confirms you want to remove it before doing so.
Members	Select an Ethernet interface or VLAN interface to add it to the bridge interface. An interface is not available in the following situations: <ul style="list-style-type: none"> • There is a virtual interface on top of it • It is already used in a different bridge interface • Each bridge interface can only have one VLAN interface.
Zone	Select the zone to which this interface is to belong. You use zones to apply security settings such as security policy, IPS, remote management, anti-malware, and application patrol. Make sure to select the correct zone as otherwise traffic may be blocked by a security policy.
DHCP Server	This option appears when Address Assignment is Use Fixed IP Address .
Enable	Select this to enable the DHCP server on the Zyxel Device.
Mode	Select what type of DHCP service the Zyxel Device provides to the network. Choices are: <p>DHCP - the Zyxel Device assigns IP addresses and provides subnet mask, gateway, and DNS server information to the network. The Zyxel Device is the DHCP server for the network.</p> <p>Relay - the Zyxel Device routes DHCP requests to one or more DHCP servers you specify. The DHCP server(s) may be on another network. You can have at most four DHCP relay servers at the same time.</p>
Start IP	Enter the IP address from which the Zyxel Device begins allocating IP addresses. If you want to assign a static IP address to a specific computer, use the Static DHCP Table . <p>If this field is blank, the Pool Size must also be blank. In this case, the Zyxel Device can assign every IP address allowed by the interface's IP address and subnet mask, except for the first address (network address), last address (broadcast address) and the interface's IP address.</p>
Pool Size	Enter the number of IP addresses to allocate. This number must be at least one and is limited by the interface's Subnet Mask . For example, if the Subnet Mask is 255.255.255.0 and Start IP is 10.10.10.10, the Zyxel Device can allocate 10.10.10.10 to 10.10.10.254, or 245 IP addresses. <p>If this field is blank, the Start IP must also be blank. In this case, the Zyxel Device can assign every IP address allowed by the interface's IP address and subnet mask, except for the first address (network address), last address (broadcast address) and the interface's IP address.</p>
First DNS Server Second DNS Server Third DNS Server	Specify the IP addresses up to three DNS servers for the DHCP clients to use. Use one of the following ways to specify these IP addresses. <p>Custom Defined - enter a static IP address.</p> <p>ZyWALL - the DHCP clients use the IP address of this interface and the Zyxel Device works as a DNS relay.</p>
First WINS Server Second WINS Server	Type the IP address of the WINS (Windows Internet Naming Service) server that you want to send to the DHCP clients. The WINS server keeps a mapping table of the computer names on your network and the IP addresses that they are currently using.
Default Router	If you set this interface to DHCP Server , you can select to use either the interface's IP address or another IP address as the default router. This default router will become the DHCP clients' default gateway. <p>To use another IP address as the default router, select Custom Defined and enter the IP address.</p>
Lease Time	Specify how long each computer can use the information (especially the IP address) before it has to request the information again.
DHCP Extended Options	This table is available if you selected DHCP server . <p>Configure this table if you want to send more information to DHCP clients through DHCP packets.</p>

Table 65 Network > Interface > Interface > Internal > Add/Edit (continued)

LABEL	DESCRIPTION
Add	Click this to create an entry in this table. See Section 7.4 on page 133 .
Edit	Select an entry in this table and click this to modify it.
Remove	Select an entry in this table and click this to delete it.
PXE Server	<p>PXE (Preboot eXecution Environment) allows a client computer to use the network to boot up and install an operating system via a PXE-capable Network Interface Card (NIC).</p> <p>PXE is available for computers on internal interfaces to allow them to boot up using boot software on a PXE server. The Zyxel Device acts as an intermediary between the PXE server and the computers that need boot software.</p> <p>The PXE server must have a public IPv4 address. You must enable DHCP Server on the Zyxel Device so that it can receive information from the PXE server.</p>
PXE Boot Loader File	A boot loader is a computer program that loads the operating system for the computer. Type the exact file name of the boot loader software file, including filename extension, that is on the PXE server. If the wrong filename is typed, then the client computers cannot boot.
Relay Server 1	
Address	Enter the IP address of a DHCP server for the network.
Upstream Interface	This field is optional. Select up to two interface(s) to use for the Zyxel Device to forward/receive DHCP packets to/from the DHCP server.
Relay Server 2	
Address	This field is optional. Enter the IP address of another DHCP server for the network.
Upstream Interface	This field is optional. Select up to two interface(s) to use for the Zyxel Device to forward/receive DHCP packets to/from the DHCP server.
Advanced Settings	
Connectivity Check	The interface can regularly check the connection to the gateway you specified to make sure it is still available. You specify how often the interface checks the connection, how long to wait for a response before the attempt is a failure, and how many consecutive failures are required before the Zyxel Device stops routing to the gateway. The Zyxel Device resumes routing to the gateway the first time the gateway passes the connectivity check.
Enable	Select this to turn on the connection check.
Check Method	<p>Select the method that the gateway allows.</p> <p>Select icmp to have the Zyxel Device regularly ping the gateway you specify to make sure it is still available.</p> <p>Select tcp to have the Zyxel Device regularly perform a TCP handshake with the gateway you specify to make sure it is still available.</p>
Check Period	Enter the number of seconds between connection check attempts.
Check Timeout	Enter the number of seconds to wait for a response before the attempt is a failure.
Check Fail Tolerance	Enter the number of consecutive failures before the Zyxel Device stops routing through the gateway.
Check These Addresses	<p>Specify one or two domain names or IP addresses for the connectivity check.</p> <p>You can type an IPv4 address in one field and a domain name in the other. For example, type "192.168.1.2" in the top field and "www.zyxel.com" in the bottom field.</p>
Check Succeeds When	<p>This field applies when you specify two domain names or IP addresses for the connectivity check.</p> <p>Select Any if you want the check to pass if at least one of the domain names or IP addresses responds.</p> <p>Select All if you want the check to pass only if both domain names or IP addresses respond.</p>
Interface Parameters	

Table 65 Network > Interface > Interface > Internal > Add/Edit (continued)

LABEL	DESCRIPTION
MTU	This is the Maximum Transmission Unit. Type the maximum size of each data packet, in bytes, that can move through this interface. If a larger packet arrives, the Zyxel Device divides it into smaller fragments. Allowed values are 1280-1500. Usually, this value is 1500.
Apply	Click Apply to save your changes back to the Zyxel Device.
Cancel	Click Cancel to return the screen to its last-saved settings.

7.4 General Interface

This section introduces general interfaces and then explains the screen for general interfaces.

Use a general interface to connect to either a local network or an external network. If you prefer not to use the automatic settings applied to **Internal** or **External** interfaces, you can create a **General** interface to specify routing policy, SNAT, and security rules.

Figure 104 Network > Interface > Interface > General > Add /Edit

These screen's fields are described in the table below.

Table 66 Network > Interface > Interface > General > Add/Edit

LABEL	DESCRIPTION
General Settings	
Enable Interface	Select this to enable this interface. Clear this to disable this interface.
Interface Properties	
Role	General is for connecting to either an external network or a local network. The rest of the screen's options do not automatically adjust and you must manually configure a policy route to add routing and SNAT settings for the interface.

Table 66 Network > Interface > Interface > General > Add/Edit

LABEL	DESCRIPTION
Interface Type	<p>Select the type of interface you want to configure.</p> <p>Select Ethernet to establish the foundation for defining other interfaces and network policies.</p> <p>Select VLAN to create an interface over an Ethernet interface that can receive and send tagged frames. The Zyxel Device automatically adds or removes the tags as needed.</p> <p>Select Bridge to create a single network between Ethernet or VLAN interfaces at the layer-2 (data link, MAC address) level. Unlike port groups, bridge interfaces can take advantage of some security features in the Zyxel Device, such as Policy Control and IP Exception. You can also assign an IP address and subnet mask to the bridge.</p>
Name	Specify a name for the interface. It can use alphanumeric characters, hyphens, and underscores, and it can be up to 11 characters long.
Port	This is the name of the Ethernet interface's physical port.
Zone	Select the zone to which this interface is to belong. You use zones to apply security settings such as security policy, IPS, remote management, anti-malware, and application patrol. Make sure to select the correct zone as otherwise traffic may be blocked by a security policy. You can create a zone object in the Object > Zone screen.
MAC Address	Have the interface use either the factory assigned default MAC address, a manually specified MAC address, or clone the MAC address of another device or computer.
Use Default MAC Address	Select this option to have the interface use the factory assigned default MAC address. By default, the Zyxel Device uses the factory assigned MAC address to identify itself.
Overwrite Default MAC Address	Select this option to have the interface use a different MAC address. Enter a MAC address in the format "xx:xx:xx:xx:xx:xx" or "xx-xx-xx-xx-xx-xx". Once it is successfully configured, the address will be copied to the configuration file. It will not change unless you change the setting or upload a different configuration file.
VLAN ID	This field displays when you select the VLAN Interface Type . Enter the VLAN ID. This 12-bit number uniquely identifies each VLAN. Allowed values are 1 - 4094. (0 and 4095 are reserved.)
Priority (802.1P)	This field displays when you select the VLAN Interface Type . Type a number between 0 and 7 to set the priority for the outgoing traffic from this interface. The bigger the number, the higher the priority.
Description	Enter a description of this interface. You can use alphanumeric and () + / : = ? ! * # @ \$ _ % - characters, and it can be up to 60 characters long. Spaces are allowed, but the string can't start with a space.
Address Assignment	These IP address fields configure an IPv4 IP address on the interface itself. If you change this IP address on the interface, you may also need to change a related address object for the network connected to the interface. For example, if you use this screen to change the IP address of your LAN interface, you should also change the corresponding LAN subnet address object.
Unassigned	Select this if you don't want to specify an IP address for this interface.
Get Automatically (DHCP)	<p>Select this to make the interface a DHCP client and automatically get the IP address, subnet mask, and gateway address from a DHCP server.</p> <p>Note: DHCP Server is disabled if you select this option. An interface cannot act as both a DHCP client and a DHCP server at the same time.</p>
Use Fixed IP Address	Select this if you want to specify the IP address, subnet mask, and gateway manually.
IP/Network Mask	<p>This field is enabled if you select Use Fixed IP Address.</p> <p>Enter the IP address the subnet mask of this interface in dot decimal notation. The subnet mask indicates what part of the IP address is the same for all computers on the network for this interface.</p>

Table 66 Network > Interface > Interface > General > Add/Edit

LABEL	DESCRIPTION
Gateway IP	<p>This field is enabled if you select Use Fixed IP Address.</p> <p>Enter the IP address of the gateway. The Zyxel Device sends packets to the gateway when it does not know how to route the packet to its destination. The gateway should be on the same network as the interface.</p> <p>Note: If you do not enter a gateway IP address here, you must go to the Network > Routing screen to create a routing policy so the Zyxel Device knows where to route the packets.</p>
Secondary IP	<p>This is available when you select Use Fixed IP Address. An interface can be bound to three additional public IP addresses. You can assign these IP addresses to different servers on the same interface, enabling the servers to receive traffic using different IP addresses and ports.</p>
Add	<p>Click this to bind up to three additional IP addresses to this interface.</p>
Remove	<p>To remove a secondary IP address, select it and click Remove. The Zyxel Device confirms you want to remove it before doing so.</p> <p>Note: Ensure the secondary IP is address not being used by any service before removing it; otherwise, or the Zyxel Device might be unable to use the service.</p>
IP/Netmask	<p>Enter the secondary IP address and subnet mask to bind to this interface.</p>
Members	<p>This is available when you select Bridge interface type.</p>
Add	<p>Click this to add a new interface. You can add up to eight interfaces to per bridge interface.</p>
Remove	<p>To remove an interface from the bridge interface, select it and click Remove. The Zyxel Device confirms you want to remove it before doing so.</p>
Members	<p>Select an Ethernet interface or VLAN interface to add it to the bridge interface. An interface is not available in the following situations:</p> <ul style="list-style-type: none"> • There is a virtual interface on top of it • It is already used in a different bridge interface • Each bridge interface can only have one VLAN interface.
Zone	<p>Select the zone to which this interface is to belong. You use zones to apply security settings such as security policy, IPS, remote management, anti-malware, and application patrol. Make sure to select the correct zone as otherwise traffic may be blocked by a security policy.</p>
DHCP Server	<p>This option appears when Address Assignment is Use Fixed IP Address.</p>
Enable	<p>Select this to enable the DHCP server on the Zyxel Device.</p>
Mode	<p>Select what type of DHCP service the Zyxel Device provides to the network. Choices are:</p> <p>DHCP - the Zyxel Device assigns IP addresses and provides subnet mask, gateway, and DNS server information to the network. The Zyxel Device is the DHCP server for the network.</p> <p>Relay - the Zyxel Device routes DHCP requests to one or more DHCP servers you specify. The DHCP server(s) may be on another network. You can have at most four DHCP relay servers at the same time.</p>
Start IP	<p>Enter the IP address from which the Zyxel Device begins allocating IP addresses. If you want to assign a static IP address to a specific computer, use the Static DHCP Table.</p> <p>If this field is blank, the Pool Size must also be blank. In this case, the Zyxel Device can assign every IP address allowed by the interface's IP address and subnet mask, except for the first address (network address), last address (broadcast address) and the interface's IP address.</p>

Table 66 Network > Interface > Interface > General > Add/Edit

LABEL	DESCRIPTION
Pool Size	<p>Enter the number of IP addresses to allocate. This number must be at least one and is limited by the interface's Subnet Mask. For example, if the Subnet Mask is 255.255.255.0 and Start IP is 10.10.10.10, the Zyxel Device can allocate 10.10.10.10 to 10.10.10.254, or 245 IP addresses.</p> <p>If this field is blank, the Start IP must also be blank. In this case, the Zyxel Device can assign every IP address allowed by the interface's IP address and subnet mask, except for the first address (network address), last address (broadcast address) and the interface's IP address.</p>
First DNS Server Second DNS Server Third DNS Server	<p>Specify the IP addresses up to three DNS servers for the DHCP clients to use. Use one of the following ways to specify these IP addresses.</p> <p>Custom Defined - enter a static IP address.</p> <p>ZyWALL - the DHCP clients use the IP address of this interface and the Zyxel Device works as a DNS relay.</p>
First WINS Server Second WINS Server	<p>Type the IP address of the WINS (Windows Internet Naming Service) server that you want to send to the DHCP clients. The WINS server keeps a mapping table of the computer names on your network and the IP addresses that they are currently using.</p>
Default Router	<p>If you set this interface to DHCP Server, you can select to use either the interface's IP address or another IP address as the default router. This default router will become the DHCP clients' default gateway.</p> <p>To use another IP address as the default router, select Custom Defined and enter the IP address.</p>
Lease Time	<p>Specify how long each computer can use the information (especially the IP address) before it has to request the information again.</p>
DHCP Extended Options	<p>This table is available if you selected DHCP server.</p> <p>Configure this table if you want to send more information to DHCP clients through DHCP packets.</p>
Add	<p>Click this to create an entry in this table. See Section 7.4 on page 133.</p>
Edit	<p>Select an entry in this table and click this to modify it.</p>
Remove	<p>Select an entry in this table and click this to delete it.</p>
PXE Server	<p>PXE (Preboot eXecution Environment) allows a client computer to use the network to boot up and install an operating system via a PXE-capable Network Interface Card (NIC).</p> <p>PXE is available for computers on internal interfaces to allow them to boot up using boot software on a PXE server. The Zyxel Device acts as an intermediary between the PXE server and the computers that need boot software.</p> <p>The PXE server must have a public IPv4 address. You must enable DHCP Server on the Zyxel Device so that it can receive information from the PXE server.</p>
PXE Boot Loader File	<p>A boot loader is a computer program that loads the operating system for the computer. Type the exact file name of the boot loader software file, including filename extension, that is on the PXE server. If the wrong filename is typed, then the client computers cannot boot.</p>
Relay Server 1	
Address	<p>Enter the IP address of a DHCP server for the network.</p>
Upstream Interface	<p>This field is optional. Select up to two interface(s) to use for the Zyxel Device to forward/receive DHCP packets to/from the DHCP server.</p>
Relay Server 2	
Address	<p>This field is optional. Enter the IP address of another DHCP server for the network.</p>
Upstream Interface	<p>This field is optional. Select up to two interface(s) to use for the Zyxel Device to forward/receive DHCP packets to/from the DHCP server.</p>

Table 66 Network > Interface > Interface > General > Add/Edit

LABEL	DESCRIPTION
Connectivity Check	The interface can regularly check the connection to the gateway you specified to make sure it is still available. You specify how often the interface checks the connection, how long to wait for a response before the attempt is a failure, and how many consecutive failures are required before the Zyxel Device stops routing to the gateway. The Zyxel Device resumes routing to the gateway the first time the gateway passes the connectivity check.
Enable	Select this to turn on the connection check.
Check Method	Select the method that the gateway allows. Select ICMP to have the Zyxel Device regularly ping the gateway you specify to make sure it is still available. Select TCP to have the Zyxel Device regularly perform a TCP handshake with the gateway you specify to make sure it is still available.
Check Period	Enter the number of seconds between connection check attempts.
Check Timeout	Enter the number of seconds to wait for a response before the attempt is a failure.
Check Fail Tolerance	Enter the number of consecutive failures before the Zyxel Device stops routing through the gateway.
Check These Addresses	Specify one or two domain names or IP addresses for the connectivity check. You can type an IPv4 address in one field and a domain name in the other. For example, type "192.168.1.2" in the top field and "www.zyxel.com" in the bottom field.
Check Succeeds When	This field applies when you specify two domain names or IP addresses for the connectivity check. Select Any if you want the check to pass if at least one of the domain names or IP addresses responds. Select All if you want the check to pass only if both domain names or IP addresses respond.
Interface Parameter	
MTU	This is the Maximum Transmission Unit. Type the maximum size of each data packet, in bytes, that can move through this interface. If a larger packet arrives, the Zyxel Device divides it into smaller fragments. Allowed values are 1280-1500. Usually, this value is 1500.
Apply	Click Apply to save your changes back to the Zyxel Device.
Cancel	Click Cancel to return the screen to its last-saved settings.

7.4.1 Add/Edit DHCP Extended Options

When you configure an interface as a DHCPv4 server, you can additionally add DHCP extended options which have the Zyxel Device to add more information in the DHCP packets. The available fields vary depending on the DHCP option you select in this screen. To open the screen, click **Network > Interface > Internal/General > Edit**, select **DHCP Mode** in the **DHCP Server** section, and then click **Add** or **Edit** in the **DHCP Extended Options** table.

Figure 105 Network > Interface > Internal > Edit > Add/Edit Extended Options

The following table describes labels that can appear in this screen.

Table 67 Network > Interface > Internal > Edit > Add/Edit Extended Options

LABEL	DESCRIPTION
Option	This field displays the name of the selected DHCP option. Select which DHCP option that you want to add in the DHCP packets sent through the interface.
Code	This field displays the code number of the selected DHCP option. If you selected User Defined in the Option field, enter a number for the option. This field is mandatory.
Type	This is the type of the selected DHCP option. If you selected User Defined in the Option field, select an appropriate type for the value that you will enter in the next field. Only advanced users should configure User Defined .
Value	Enter the value for the selected DHCP option. For example, if you selected TFTP Server Name (66) and the type is TEXT , enter the DNS domain name of a TFTP server here. This field is mandatory.
First IP Address, Second IP Address, Third IP Address	If you selected Time Server (4) , NTP Server (41) , SIP Server (120) , CAPWAP AC (138) , or TFTP Server (150) , you have to enter at least one IP address of the corresponding servers in these fields. The servers should be listed in order of your preference.
First Enterprise ID, Second Enterprise ID	If you selected VIVC (124) or VIVS (125) , you have to enter at least one vendor's 32-bit enterprise number in these fields. An enterprise number is a unique number that identifies a company.
First Class, Second Class	If you selected VIVC (124) , enter the details of the hardware configuration of the host on which the client is running, or of industry consortium compliance.
First Information, Second Information	If you selected VIVS (125) , enter additional information for the corresponding enterprise number in these fields.
OK	Click this to close this screen and update the settings to the previous Edit screen.
Cancel	Click Cancel to close the screen.

The following table lists the available DHCP extended options (defined in RFCs) on the Zyxel Device. See RFCs for more information.

Table 68 DHCP Extended Options

OPTION NAME	CODE	DESCRIPTION
Time Offset	2	This option specifies the offset of the client's subnet in seconds from Coordinated Universal Time (UTC).
Time Server	4	This option specifies a list of Time servers available to the client.

Table 68 DHCP Extended Options (continued)

OPTION NAME	CODE	DESCRIPTION
Domain Name	15	This option specifies the domain name that the client should use when resolving hostnames through the Domain Name System.
Interface MTU	26	This option specifies the MTU (Maximum Transmission Unit) to use on this interface, with an available range of 68 to 65535 bytes for IPv4 packets.
NTP Server	42	This option specifies a list of the NTP servers available to the client by IP address.
Netbios Scope	47	This option specifies the NetBIOS over TCP/IP scope parameter for the client.
DHCP Server Identifier	54	This option specifies the IP address of the DHCP server.
TFTP Server Name	66	This option is used to identify a TFTP server when the "sname" field in the DHCP header has been used for DHCP options. The minimum length of the value is 1.
Bootfile	67	This option is used to identify a bootfile when the "file" field in the DHCP header has been used for DHCP options. The minimum length of the value is 1.
SIP Server	120	This option carries either an IPv4 address or a DNS domain name to be used by the SIP client to locate a SIP server.
VIVC	124	Vendor-Identifying Vendor Class option A DHCP client may use this option to unambiguously identify the vendor that manufactured the hardware on which the client is running, the software in use, or an industry consortium to which the vendor belongs.
VIVS	125	Vendor-Identifying Vendor-Specific option DHCP clients and servers may use this option to exchange vendor-specific information.
CAPWAP AC	138	CAPWAP Access Controller addresses option The Control And Provisioning of Wireless Access Points Protocol allows a Wireless Termination Point (WTP) to use DHCP to discover the Access Controllers to which it is to connect. This option carries a list of IPv4 addresses indicating one or more CAPWAP ACs available to the WTP.
TFTP Server	150	The option contains one or more IPv4 addresses that the client may use. The current use of this option is for downloading configuration from a VoIP server via TFTP; however, the option may be used for purposes other than contacting a VoIP configuration server.

7.5 VTI Interface

IPSec VPN Tunnel Interface (VTI) encrypts or decrypts IPv4 traffic from or to the interface according to the IP routing table.

VTI allows static routes to send traffic over the VPN. The IPSec tunnel endpoint is associated with an actual (virtual) interface. Therefore many interface capabilities such as Policy Route, Static Route, Trunk, and BWM can be applied to the IPSec tunnel as soon as the tunnel is active

IPSec VTI simplifies network management and load balancing. Create a trunk using VPN tunnel interfaces for load balancing. In the following example configure VPN tunnels with static IP addresses or DNS on both Zyxel Devices (or IPSec routers at the end of the tunnel). Also configure VTI and a trunk on both Zyxel Devices.

Figure 106 VTI and Trunk for VPN Load Balancing

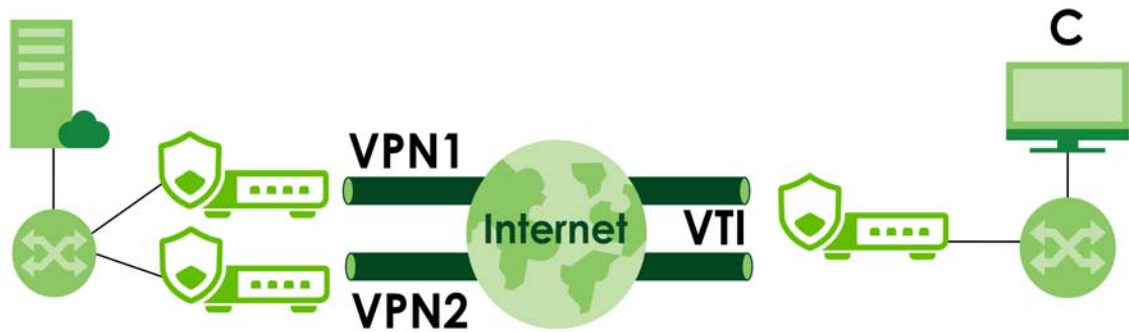

7.5.1 Restrictions for IPSec Virtual Tunnel Interface

- IPv4 traffic only
- IPSec tunnel mode only. A shared keyword must not be configured when using tunnel mode.
- With a VTI VPN you do not add local or remote LANs to your VPN configuration.
- For a VTI VPN you should only have one local and one remote WAN.
- A dynamic peer is not supported
- The IPSec VTI is limited to IP unicast and multicast traffic only.

7.5.2 VTI Edit

This screen lets you configure IP address assignment and interface parameters for VTI.

Note: You should have created a route-based VPN tunnel for a VPN Tunnel Interface scenario first.

To access this screen, click the **Network > Interface > Interface > VTI > Edit**. The following screen appears.

Figure 107 Network > Interface > Interface > VTI > Edit

The screenshot shows the configuration page for a VTI interface. The breadcrumb trail is Network > Interface > Interface > VTI > Edit. The page is divided into several sections:

- General Settings:** Includes a toggle for 'Enable Interface' which is currently turned on.
- Interface Properties:** Includes fields for 'Interface Name' (vfi_wizard_824), 'VPN Rule' (free), 'Zone' (IPSec_VPN), and 'IP/Network Mask' (169.254.148.254/2).
- Advanced Settings:** A collapsed section containing:
 - Connectivity Check:** Includes a toggle for 'Enable' (turned off), 'Check Method' (ICMP), 'Check Period' (30 seconds), 'Check Timeout' (5 seconds), 'Check Fail Tolerance' (5), 'Check These Address' (empty), and 'Check Succeeds When' (Any).
 - Interface Parameter:** Includes 'MTU' (1500 Bytes).

A green notification box at the bottom right states: 'Some changes were made. What do you want to do then?' with 'Cancel' and 'Apply' buttons.

Each field is described in the table below.

Table 69 Network > Interface > Interface > VTI > Edit

LABEL	DESCRIPTION
General Settings	
Enable Interface	Slide the switch to the right to enable VTI.
Interface Properties	
Interface Name	This field displays the name of the VPN tunnel interface. This field is read-only.
VPN Rule	This field displays the scenario rule the VPN tunnel interface is using.
Zone	Select a zone. Make sure that the zone you select does not have traffic blocked by a security feature such as a security policy.
IP Address	Enter the IP address for this interface.
Connectivity Check	The interface can regularly check the connection to the gateway you specified to make sure it is still available. You specify how often the interface checks the connection, how long to wait for a response before the attempt is a failure, and how many consecutive failures are required before the ZyXel Device stops routing to the gateway. The ZyXel Device resumes routing to the gateway the first time the gateway passes the connectivity check.
Enable	Select this to turn on the connection check.

Table 69 Network > Interface > Interface > VTI > Edit (continued)

LABEL	DESCRIPTION
Check Method	<p>Select the method that the gateway allows.</p> <p>Select icmp to have the Zyxel Device regularly ping the gateway you specify to make sure it is still available.</p> <p>Select tcp to have the Zyxel Device regularly perform a TCP handshake with the gateway you specify to make sure it is still available.</p>
Check Period	Enter the number of seconds between connection check attempts.
Check Timeout	Enter the number of seconds to wait for a response before the attempt is a failure.
Check Fail Tolerance	Enter the number of consecutive failures before the Zyxel Device stops routing through the gateway.
Check These Addresses	<p>Specify one or two domain names or IP addresses for the connectivity check.</p> <p>You can type an IPv4 address in one field and a domain name in the other. For example, type "192.168.1.2" in the top field and "www.zyxel.com" in the bottom field.</p>
Check Succeeds When	<p>This field applies when you specify two domain names or IP addresses for the connectivity check.</p> <p>Select Any if you want the check to pass if at least one of the domain names or IP addresses responds.</p> <p>Select All if you want the check to pass only if both domain names or IP addresses respond.</p>
MTU	This is the Maximum Transmission Unit. Type the maximum size of each data packet, in bytes, that can move through this interface. If a larger packet arrives, the Zyxel Device divides it into smaller fragments. Allowed values are 1280-1500.
OK	Click OK to save your changes back to the Zyxel Device.
Cancel	Click Cancel to return the screen to its last-saved settings.

7.6 Trunk Overview

Use trunks for WAN traffic load balancing to increase overall network throughput and reliability. Load balancing divides traffic loads between multiple interfaces. This allows you to improve quality of service and maximize bandwidth utilization for multiple ISP links.

Maybe you have two Internet connections with different bandwidths. You could set up a trunk that uses weighted round robin load balancing so time-sensitive traffic (like video) usually goes through the higher-bandwidth interface. For other traffic, you might want to use least load first load balancing to even out the distribution of the traffic load.

Suppose ISP A has better connections to Europe while ISP B has better connections to Australia. You could use policy routes and trunks to have traffic for your European branch office primarily use ISP A and traffic for your Australian branch office primarily use ISP B.

Or maybe one of the Zyxel Device's interfaces is connected to an ISP that is also your Voice over IP (VoIP) service provider. You can use policy routing to send the VoIP traffic through a trunk with the interface connected to the VoIP service provider set to active and another interface (connected to another ISP) set to passive. This way VoIP traffic goes through the interface connected to the VoIP service provider whenever the interface's connection is up.

Throughput is the moving average of traffic passing through the Zyxel Device in the last 10 seconds updated every 1 second.

Load Balancing Algorithms

The following sections describe the load balancing algorithms the Zyxel Device can use to decide which interface the traffic (from the LAN) should use for a session. The available bandwidth you configure on the Zyxel Device refers to the actual bandwidth provided by the ISP and the measured bandwidth refers to the bandwidth an interface is currently using.

Least Load First

The least load first algorithm uses the current (or recent) outbound bandwidth utilization of each trunk member interface as the load balancing index(es) when making decisions about to which interface a new session is to be distributed. The outbound bandwidth utilization is defined as the measured outbound throughput over the available outbound bandwidth.

Here the Zyxel Device has two WAN interfaces connected to the Internet. The configured available outbound bandwidths for WAN 1 and WAN 2 are 512K and 256K respectively.

Figure 108 Load Balancing Least Load First Example

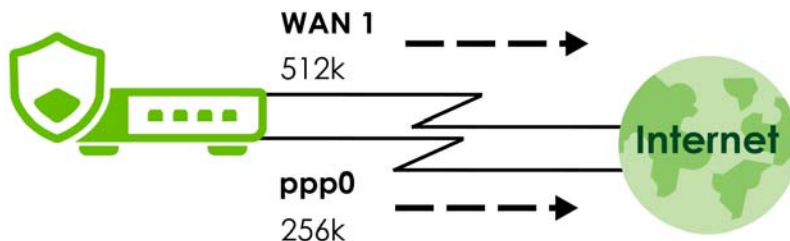

The outbound bandwidth utilization is used as the load balancing index. In this example, the measured (current) outbound throughput of WAN 1 is 412K and WAN 2 is 198K. The Zyxel Device calculates the load balancing index as shown in the table below.

Since WAN 2 has a smaller load balancing index (meaning that it is less utilized than WAN 1), the Zyxel Device will send the subsequent new session traffic through WAN 2.

Table 70 Least Load First Example

INTERFACE	OUTBOUND		LOAD BALANCING INDEX (M/A)
	AVAILABLE (A)	MEASURED (M)	
WAN 1	512 K	412 K	0.8
WAN 2	256 K	198 K	0.77

Weighted Round Robin

Round Robin scheduling services queues on a rotating basis and is activated only when an interface has more traffic than it can handle. A queue is given an amount of bandwidth irrespective of the incoming traffic on that interface. This queue then moves to the back of the list. The next queue is given an equal amount of bandwidth, and then moves to the end of the list; and so on, depending on the number of queues being used. This works in a looping fashion until a queue is empty.

The Weighted Round Robin (WRR) algorithm is best suited for situations when the bandwidths set for the two WAN interfaces are different. Similar to the Round Robin (RR) algorithm, the Weighted Round Robin (WRR) algorithm sets the Zyxel Device to send traffic through each WAN interface in turn. In addition, the

WAN interfaces are assigned weights. An interface with a larger weight gets more chances to transmit traffic than an interface with a smaller weight.

For example, in the figure below, the configured available bandwidth of WAN1 is 1M and WAN2 is 512K. You can set the Zyxel Device to distribute the network traffic between the two interfaces by setting the weight of wan1 and wan2 to 2 and 1 respectively. The Zyxel Device assigns the traffic of two sessions to wan1 and one session's traffic to wan2 in each round of 3 new sessions.

Figure 109 Weighted Round Robin Algorithm Example

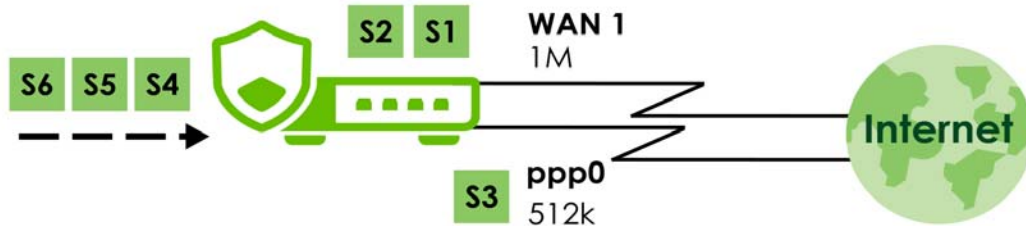

Spillover

The spillover load balancing algorithm sends network traffic to the first interface in the trunk member list until the interface's maximum allowable load is reached, then sends the excess network traffic of new sessions to the next interface in the trunk member list. This continues as long as there are more member interfaces and traffic to be sent through them.

Suppose the first trunk member interface uses an unlimited access Internet connection and the second is billed by usage. Spillover load balancing only uses the second interface when the traffic load exceeds the threshold on the first interface. This fully utilizes the bandwidth of the first interface to reduce Internet usage fees and avoid overloading the interface.

In this example figure, the upper threshold of the first interface is set to 800K. The Zyxel Device sends network traffic of new sessions that exceed this limit to the secondary WAN interface.

Figure 110 Spillover Algorithm Example

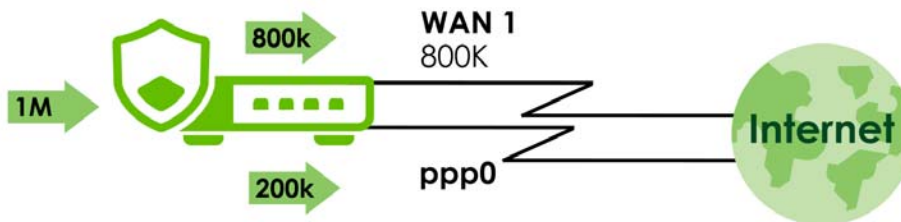

- Use the **Trunk** summary screen ([Section 7.7 on page 146](#)) to view the list of configured trunks and which load balancing algorithm each trunk uses.
- Use the **Add Trunk** screen ([Section 7.7.1 on page 147](#)) to configure the member interfaces for a trunk and the load balancing algorithm the trunk uses.
- Use the **Add System Default** screen ([Section 7.7.2 on page 149](#)) to configure the load balancing algorithm for the system default trunk.

7.6.1 What You Need to Know

- Add WAN interfaces to trunks to have multiple connections share the traffic load.

- If one WAN interface's connection goes down, the Zyxel Device sends traffic through another member of the trunk.
- For example, you connect one WAN interface to one ISP and connect a second WAN interface to a second ISP. The Zyxel Device balances the WAN traffic load between the connections. If one interface's connection goes down, the Zyxel Device can automatically send its traffic through another interface.

You can also use trunks with policy routing to send specific traffic types through the best WAN interface for that type of traffic.

- If that interface's connection goes down, the Zyxel Device can still send its traffic through another interface.
 - You can define multiple trunks for the same physical interfaces.
- 1** LAN user **A** logs into server **B** on the Internet. The Zyxel Device uses wan1 to send the request to server **B**.
 - 2** The Zyxel Device is using active/active load balancing. So when LAN user **A** tries to access something on the server, the request goes out through wan2.
 - 3** The server finds that the request comes from wan2's IP address instead of wan1's IP address and rejects the request.

If link sticking had been configured, the Zyxel Device would have still used wan1 to send LAN user **A**'s request to the server and server would have given the user **A** access.

7.7 The Trunk Summary Screen

Click **Network > Interface > Trunk** to open the **Trunk** screen. The following screen lists the configured trunks and the load balancing algorithm that each is configured to use.

Figure 111 Network > Interface > Trunk

Network > Interface > Trunk

Interface **Trunk** Port

Default WAN Trunk

Trunk Selection Default Trunk User-Defined Trunk

User-Defined Trunk

+ Add Edit Remove Reference Search insights

Name	Algorithm	Members	Reference
No data			

Default Trunk

Edit Search insights

Name	Algorithm	Members
Default	wrr	ge1, ge2

The following table describes the items in this screen.

Table 71 Network > Interface > Trunk

LABEL	DESCRIPTION
Trunk Selection	Select whether the Zyxel Device is to use the default system WAN trunk or one of the user configured WAN trunks as the default trunk for routing traffic from internal interfaces to external interfaces.
Add	Click this to create a new user-configured trunk.
Edit	Double-click an entry or select it and click Edit to open a screen where you can modify the entry's settings.
Remove	To remove a user-configured trunk, select it and click Remove . The Zyxel Device confirms you want to remove it before doing so.
Reference	This field displays the objects this entry uses.
Name	This field displays the label that you specified to identify the trunk.
Algorithm	This field displays the load balancing method the trunk is set to use.
Members	This field displays the interfaces that belong to the trunk.
Reference	This field displays which settings use the entry.

7.7.1 Configuring a User-Defined Trunk

Click **Network > Interface > Trunk**, in the **User-Defined Trunk** table click the **Add** (or **Edit**) icon to open the following screen. Use this screen to create or edit a WAN trunk entry.

Figure 112 Network > Interface > Trunk > User-Defined Trunk > Add (or Edit)

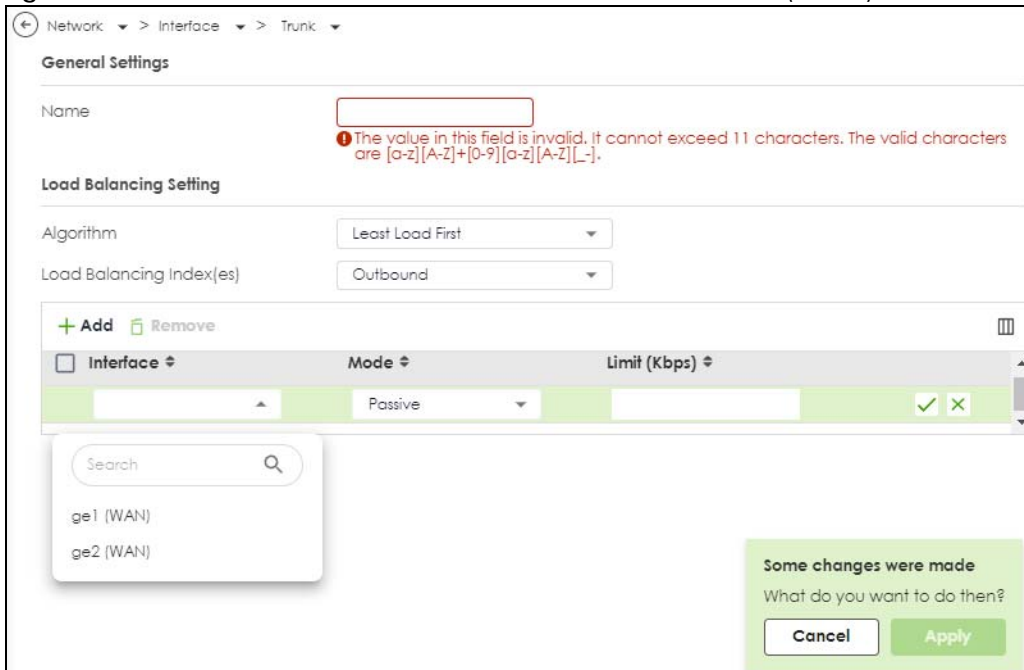

Each field is described in the table below.

Table 72 Network > Interface > Trunk > Add/Edit

LABEL	DESCRIPTION
Name	This is read-only if you are editing an existing trunk. When adding a new trunk, enter a descriptive name for this trunk. The value in this field cannot exceed 11 characters. The valid characters are [a-z][A-Z][_].
Load Balancing Algorithm	Select a load balancing method to use from the drop-down list box. Select Weighted Round Robin to balance the traffic load between interfaces based on their respective weights. An interface with a larger weight gets more chances to transmit traffic than an interface with a smaller weight. For example, if the weight ratio of wan1 and wan2 interfaces is 2:1, the ZyXel Device chooses wan1 for 2 sessions' traffic and wan2 for 1 session's traffic in each round of 3 new sessions. Select Least Load First to send new session traffic through the least utilized trunk member. Select Spillover to send network traffic through the first interface in the group member list until there is enough traffic that the second interface needs to be used (and so on).
Load Balancing Index(es)	This field is available if you selected to use the Least Load First or Spillover method. Select Outbound , Inbound , or Outbound + Inbound to set the traffic to which the ZyXel Device applies the load balancing method. Outbound means the traffic traveling from an internal interface (ex. LAN) to an external interface (ex. WAN). Inbound means the opposite.
Add	Click this to create a WAN trunk entry.
Edit	Select an entry and click Edit to modify the entry's settings.
Remove	To remove a member interface, select it and click Remove . The ZyXel Device confirms you want to remove it before doing so.
Name	Select an interface name from the drop-down list box.

Table 72 Network > Interface > Trunk > Add/Edit (continued)

LABEL	DESCRIPTION
Mode	Click this table cell and select Active to have the Zyxel Device always attempt to use this connection. Select Passive to have the Zyxel Device only use this connection when all of the connections set to active are down. You can only set one of a group's interfaces to passive mode.
Parameter	This field displays with the weighted round robin load balancing algorithm. Specify the weight (1~10) for the interface. The weights of the different member interfaces form a ratio. This ratio determines how much traffic the Zyxel Device assigns to each member interface. The higher an interface's weight is (relative to the weights of the interfaces), the more sessions that interface should handle.
Apply	Click this button to save your changes to the Zyxel Device.
Cancel	Click Cancel to return the screen to its last-saved settings.

7.7.2 Configuring the System Default Trunk

Go to **Network > Interface > Trunk > Default Trunk**, select the default trunk entry and click **Edit** to open the following screen. Use this screen to change the load balancing algorithm and view the bandwidth allocations for each member interface.

Note: The new session is allocated to each member interface equally and is not allowed to be changed for the default trunk.

Figure 113 Network > Interface > Trunk > Default Trunk > Edit

General Settings		
Name	Default	
Load Balancing Setting		
Algorithm	wrr	
Interface	Mode	Parameter
ge1	Active	1
ge2	Active	1

Each field is described in the table below.

Table 73 Network > Interface > Trunk > Default Trunk > Edit

LABEL	DESCRIPTION
Name	This field displays the name of the selected system default trunk.
Load Balancing Setting	This field displays the load balancing method use for the default trunk. Weighted Round Robin (wrr) balances the traffic load between interfaces based on their respective weights. An interface with a larger weight gets more chances to transmit traffic than an interface with a smaller weight. For example, if the weight ratio of wan1 and wan2 interfaces is 2:1, the Zyxel Device chooses wan1 for 2 sessions' traffic and wan2 for 1 session's traffic in each round of 3 new sessions.
	The table lists the trunk's member interfaces. This table is read-only.

Table 73 Network > Interface > Trunk > Default Trunk > Edit (continued)

LABEL	DESCRIPTION
Interface	This column displays the name of the member interfaces.
Mode	This field displays Active if the Zyxel Device always attempt to use this connection. This field displays Passive if the Zyxel Device only use this connection when all of the connections set to active are down. Only one of a group's interfaces can be set to passive mode.
Parameter	This field displays with the weighted round robin load balancing algorithm. Specify the weight (1~10) for the interface. The weights of the different member interfaces form a ratio. s
Apply	Click Apply to save your changes to the Zyxel Device.
Cancel	Click Cancel to return the screen to its last-saved settings.

7.8 Port

Use this screen to configure port settings. Click **Network > Interface > Port** in the navigation panel to display the configuration screen.

Figure 114 Network > Interface > Port

Virtual Device

USG FLEX 500H

Configuration





Name	Status	Type	Setting	Interface	POE
p1	Auto	Copper	Auto Negotiate	ge1	
p2	Auto	Copper	Auto Negotiate	ge2	
p3	Auto	Copper	Auto Negotiate	ge3	Enable
p4	Auto	Copper	Auto Negotiate	ge3	Disable
p5	Auto	Copper	Auto Negotiate	ge3	
p6	Auto	Copper	Auto Negotiate	ge3	
p7	Auto	Copper	Auto Negotiate	ge4	
p8	Auto	Copper	Auto Negotiate	ge4	
p9	Auto	Copper	Auto Negotiate	ge4	
p10	Auto	Copper	Auto Negotiate	ge4	
p11	Auto	Copper	Auto Negotiate		
p12	Auto	Copper	Auto Negotiate		

Each field is described in the following table.

Table 74 Network > Interface > Port

LABEL	DESCRIPTION
Virtual Device	This shows which ports are up or down on the Zyxel Device. Hover over a port to see port details such as name, status, interface and IP address.
Configuration	Select an entry to configure the speed negotiation setting of the Ethernet connection on this port and PoE if the port supports it.
Name	This field displays the name of the port.
Status	This field displays the speed and the duplex mode of the Ethernet connection on the port.
Type	This field displays the cable type that is used on the port.

Table 74 Network > Interface > Port

LABEL	DESCRIPTION
Setting	<p>Select the speed and the duplex mode of the Ethernet connection on this port. Choices are Auto Negotiate, 10Mbps, 100Mbps, 1Gbps and 2.5Gbps.</p> <p>Selecting Auto Negotiate allows one port to negotiate with a peer port automatically to obtain the connection speed (of up to 1000M) and duplex mode that both ends support. When auto-negotiation is turned on, a port on the Zyxel Device negotiates with the peer automatically to determine the connection speed and duplex mode. If the peer port does not support auto-negotiation or turns off this feature, the Zyxel Device determines the connection speed by detecting the signal on the cable and using half duplex mode. When the Zyxel Device's auto-negotiation is turned off, a port uses the pre-configured speed and duplex mode when making a connection, thus requiring you to make sure that the settings of the peer port are the same in order to connect.</p>
Interface	This field displays the interface for the port.
PoE	If the port supports PoE, then this field displays if PoE is enabled on the port.
Edit	<p>Select an entry and click this icon to modify it.</p> 
Remove	<p>Select an entry and click this icon to delete it.</p> 
Save Changes	<p>Click this icon to save the changes in this row.</p> 
Cancel Changes	<p>Click this icon to cancel the changes in this row.</p> 

CHAPTER 8

Routing

8.1 Policy and Static Routes Overview

Use policy routes and static routes to override the Zyxel Device's default routing behavior in order to send packets through the appropriate interface or VPN tunnel.

For example, the next figure shows a computer (**A**) connected to the Zyxel Device's LAN interface. The Zyxel Device routes most traffic from **A** to the Internet through the Zyxel Device's default gateway (**R1**). You create one policy route to connect to services offered by your ISP behind router **R2**. You create another policy route to communicate with a separate network behind another router (**R3**) connected to the LAN.

Figure 115 Example of Policy Routing Topology

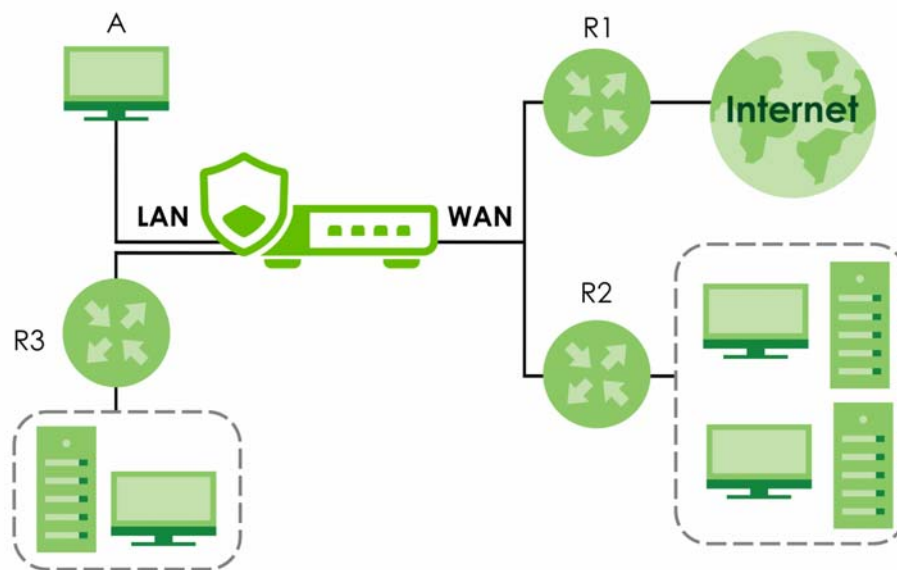

8.1.1 What You Can Do in this Chapter

- Use the **Policy Route** screens (see [Section 8.2 on page 155](#)) to list and configure policy routes.
- Use the **Static Route** screens (see [Section 8.3 on page 160](#)) to list and configure static routes.

8.1.2 What You Need to Know

Policy Routing

Traditionally, routing is based on the destination address only and the Zyxel Device takes the shortest path to forward a packet. IP Policy Routing (IPPR) provides a mechanism to override the default routing

behavior and alter the packet forwarding based on the policy defined by the network administrator. Policy-based routing is applied to incoming packets on a per interface basis, prior to the normal routing.

How You Can Use Policy Routing

- Source-Based Routing – Network administrators can use policy-based routing to direct traffic from different users through different connections.
- Cost Savings – IPPR allows organizations to distribute interactive traffic on high-bandwidth, high-cost paths while using low-cost paths for batch traffic.
- Load Sharing – Network administrators can use IPPR to distribute traffic among multiple paths.
- NAT - The Zyxel Device performs NAT by default for traffic going to or from the **WAN** interfaces. A routing policy's SNAT allows network administrators to have traffic received on a specified interface use a specified IP address as the source IP address.

Note: The Zyxel Device automatically uses SNAT for traffic it routes from internal interfaces to external interfaces. For example LAN to WAN traffic.

Static Routes

The Zyxel Device usually uses the default gateway to route outbound traffic from computers on the LAN to the Internet. To have the Zyxel Device send data to devices not reachable through the default gateway, use static routes.

Policy Routes Versus Static Routes

- Policy routes are more flexible than static routes. You can select more criteria for the traffic to match and can also use schedules, NAT, and bandwidth management.
- Policy routes take priority over static routes. If you need to use a routing policy on the Zyxel Device and propagate it to other routers, you could configure a policy route and an equivalent static route.

DiffServ

QoS is used to prioritize source-to-destination traffic flows. All packets in the same flow are given the same priority. CoS (class of service) is a way of managing traffic in a network by grouping similar types of traffic together and treating each type as a class. You can use CoS to give different priorities to different packet types.

DiffServ (Differentiated Services) is a class of service (CoS) model that marks packets so that they receive specific per-hop treatment at DiffServ-compliant network devices along the route based on the application types and traffic flow. Packets are marked with DiffServ Code Points (DSCPs) indicating the level of service desired. This allows the intermediary DiffServ-compliant network devices to handle the packets differently depending on the code points without the need to negotiate paths or remember state information for every flow. In addition, applications do not have to request a particular service or give advanced notice of where the traffic is going.

DSCP Marking and Per-Hop Behavior

DiffServ defines a new DS (Differentiated Services) field to replace the Type of Service (TOS) field in the IP header. The DS field contains a 2-bit unused field and a 6-bit DSCP field which can define up to 64 service levels. The following figure illustrates the DS field.

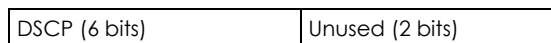

DSCP is backward compatible with the three precedence bits in the ToS octet so that non-DiffServ compliant, ToS-enabled network device will not conflict with the DSCP mapping.

The DSCP value determines the forwarding behavior, the PHB (Per-Hop Behavior), that each packet gets across the DiffServ network. Based on the marking rule, different kinds of traffic can be marked for different kinds of forwarding. Resources can then be allocated according to the DSCP values and the configured policies.

NAT and SNAT

NAT (Network Address Translation - NAT, RFC 1631) is the translation of the IP address in a packet in one network to a different IP address in another network. Use SNAT (Source NAT) to change the source IP address in one network to a different IP address in another network.

Assured Forwarding (AF) PHB for DiffServ

Assured Forwarding (AF) behavior is defined in RFC 2597. The AF behavior group defines four AF classes. Inside each class, packets are given a high, medium or low drop precedence. The drop precedence determines the probability that routers on the network will drop packets when congestion occurs. If congestion occurs between classes, the traffic in the higher class (smaller numbered class) is generally given priority. Combining the classes and drop precedence produces the following twelve DSCP encodings from AF11 through AF43. The decimal equivalent is listed in brackets.

Table 75 Assured Forwarding (AF) Behavior Group

	CLASS 1	CLASS 2	CLASS 3	CLASS 4
Low Drop Precedence	AF11 (10)	AF21 (18)	AF31 (26)	AF41 (34)
Medium Drop Precedence	AF12 (12)	AF22 (20)	AF32 (28)	AF42 (36)
High Drop Precedence	AF13 (14)	AF23 (22)	AF33 (30)	AF43 (38)

8.2 Policy Route Screen

Click **Network > Routing** to open the **Policy Route** screen. Use this screen to see the configured policy routes and turn policy routing based bandwidth management on or off.

A policy route defines the matching criteria and the action to take when a packet meets the criteria. The action is taken only when all the criteria are met. The criteria can include the user name, source address and incoming interface, destination address, schedule, IP protocol (ICMP, UDP, TCP, etc.) and port.

The actions that can be taken include:

- Routing the packet to a different gateway, outgoing interface, VTI interface, or trunk.

Figure 116 Network > Routing > Policy Route

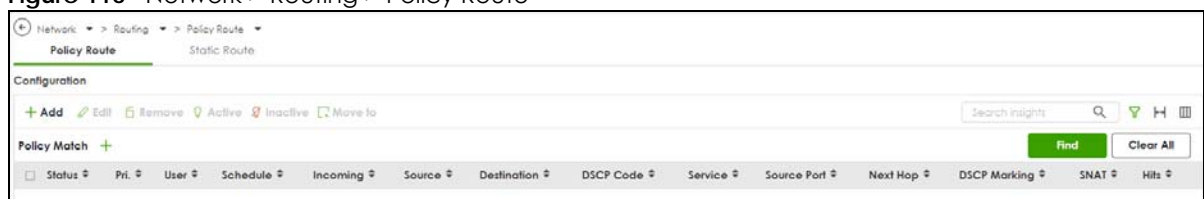

The following table describes the labels in this screen.

Table 76 Network > Routing > Policy Route

LABEL	DESCRIPTION
Use IPv4 Policy Route to Override Direct Route	Select this to have the Zyxel Device forward packets that match a policy route according to the policy route instead of sending the packets directly to a connected network.
Add	Click this to create a new entry. Select an entry and click Add to create a new entry after the selected entry.
Edit	Double-click an entry or select it and click Edit to open a screen where you can modify the entry's settings.
Remove	To remove an entry, select it and click Remove . The Zyxel Device confirms you want to remove it before doing so.
Active	Select one or more policies, then click this to enable the selected policies. The Status light changes accordingly.
Inactive	Select one or more policies, then click this to disable the selected policies. The Status light changes accordingly.
Move to	Select a policy, click this, enter a new location up to and including the last policy number, then press [ENTER] to move it to the new location. Policies are checked in order beginning from the first.
Search	Type an item in the search box, then click this to display all sessions in the table below according to the item you typed.
Clear All	Click this to remove all items found in the search.
Filter	Click the Filter icon  , click + to expand Policy Match , pick a filter, then click Find to display specific sessions according to the filter selected. You may select multiple filters, but just one of each type, configured one at a time. 
Status	This icon is lit when the entry is active, red when the next hop's connection is down, and dimmed when the entry is inactive.
Priority	This is the row number of the policy. Policies are checked in order beginning from the first.
User	This is the name of the user (group) object from which the packets are sent. any means all users.
Schedule	This is the name of the schedule object. any means the route is active at all times if enabled.
Incoming	This is the interface on which the packets are received.
Source	This is the name of the source IP address (group) object, including geographic address and FQDN (group) objects. any means all IP addresses.
Destination	This is the name of the destination IP address (group) object, including geographic and FQDN (group) address objects. any means all IP addresses.

Table 76 Network > Routing > Policy Route (continued)

LABEL	DESCRIPTION
DSCP Code	This is the DSCP value of incoming packets to which this policy route applies. any means all DSCP values or no DSCP marker. default means traffic with a DSCP value of 0. This is usually best effort traffic The " af " entries stand for Assured Forwarding. The number following the " af " identifies one of four classes and one of three drop preferences. See Assured Forwarding (AF) PHB for DiffServ for more details.
Service	This is the name of the destination service object. any means all destination services.
Source Port	This is the name of the source service object. any means all source services.
Next-Hop	This is the next hop to which packets are directed. It helps forward packets to their destinations and can be an IP address of a router or a VTI interface.
DSCP Marking	This is how the Zyxel Device handles the DSCP value of the outgoing packets that match this route. If this field displays a DSCP value, the Zyxel Device applies that DSCP value to the route's outgoing packets. preserve means the Zyxel Device does not modify the DSCP value of the route's outgoing packets. default means the Zyxel Device sets the DSCP value of the route's outgoing packets to 0. The " af " choices stand for Assured Forwarding. The number following the " af " identifies one of four classes and one of three drop preferences. See Assured Forwarding (AF) PHB for DiffServ for more details.
SNAT	This is the source IP address that the route uses. It displays none if the Zyxel Device does not perform NAT for this route.
Hits	This is the number of sessions with traffic that matched the policy criteria.
Apply	Click Apply to save your changes back to the Zyxel Device.
Cancel	Click Cancel to return the screen to its last-saved settings.

8.2.1 Policy Route Edit Screen

Click **Network > Routing** to open the **Policy Route** screen. Then click the **Add** or **Edit** icon. The **Add Policy Route** or **Policy Route Edit** screen opens. Use this screen to configure or edit a policy route.

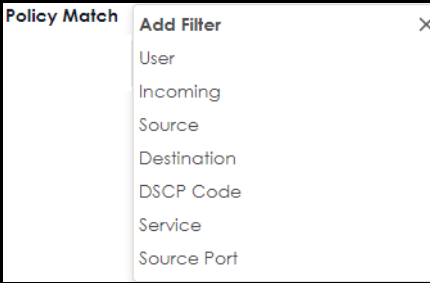
Figure 117 Network > Routing > Policy Route > Add/Edit

The following table describes the labels in this screen.

Table 77 Network > Routing > Policy Route > Add/Edit

LABEL	DESCRIPTION
Enable	Select this to activate the rule.
Name	Enter a name to identify this rule.
Description	Enter a descriptive name consists of 1 to 60 single-byte characters, including a-zA-Z0-9. Special characters and spaces are allowed.
Criteria	
User	Select a user name or user group from which the packets are sent.
Incoming	Select where the packets are coming from; any, an interface, a tunnel, an SSL VPN, or the Zyxel Device itself. For an interface, a tunnel, or an SSL VPN, you also need to select the individual interface, VPN tunnel, or SSL VPN connection.
Source Address	Select a source IP address object, including geographic address and FQDN (group) objects, from which the packets are sent.

Table 77 Network > Routing > Policy Route > Add/Edit (continued)

LABEL	DESCRIPTION
Destination Address	Select a destination IP address object, including geographic address and FQDN (group) objects, to which the traffic is being sent. If the next hop is a dynamic VPN tunnel and you enable Auto Destination Address , the Zyxel Device uses the local network of the peer router that initiated an incoming dynamic IPsec tunnel as the destination address of the policy instead of your configuration here.
DSCP Code	<p>Select a DSCP code point value of incoming packets to which this policy route applies or select User Define to specify another DSCP code point. The lower the number the higher the priority with the exception of 0 which is usually given only best-effort treatment.</p> <p>any means all DSCP value or no DSCP marker.</p> <p>default means traffic with a DSCP value of 0. This is usually best effort traffic</p> <p>The "af" choices stand for Assured Forwarding. The number following the "af" identifies one of four classes and one of three drop preferences. See Assured Forwarding (AF) PHB for DiffServ for more details.</p>
User-Defined DSCP Code	Use this field to specify a custom DSCP code point when you select User Define in the previous field.
Schedule	Select a schedule to control when the policy route is active. none means the route is active at all times if enabled.
Service	Select a destination service or service group to identify the type of traffic to which this policy route applies.
Source Port	Select a source service or service group to identify the source port of packets to which the policy route applies.
Next-Hop	
Type	<p>Select Auto to have the Zyxel Device use the routing table to find a next-hop and forward the matched packets automatically.</p> <p>Select Interface to route the matched packets through the specified outgoing interface to a gateway (which is connected to the interface).</p> <p>Select gateway to route the matched IPv6 packets through a 6to4 tunnel to the packets' destination.</p> <p>Select gateway-ip to route the matched packets to the next-hop router or switch you specified in the Host IP Address field. You have to set up the next-hop router or switch as a HOST address object first.</p> <p>Select trunk to route the matched packets through the interfaces in the trunk group based on the load balancing algorithm.</p>
Interface	This field displays when you select Interface in the Type field. Select an interface to have the Zyxel Device send traffic that matches the policy route through the specified interface.
Service	This field displays when you select gateway in the Type field. IP6to4-Relay service enables IPv6 packets to cross IPv4 networks; see Section 8.1.2 on page 153 for more information.
Host IP Address	This field displays when you select gateway-ip in the Type field. Select a HOST address object. The gateway is an immediate neighbor of your Zyxel Device that will forward the packet to the destination. The gateway must be a router or switch on the same segment as your Zyxel Device's interface(s).
Trunk	This field displays when you select trunk in the Type field. Select a trunk group to have the Zyxel Device send the packets via the interfaces in the group.

Table 77 Network > Routing > Policy Route > Add/Edit (continued)

LABEL	DESCRIPTION
DSCP Marking	<p>Set how the Zyxel Device handles the DSCP value of the outgoing packets that match this route.</p> <p>Select one of the pre-defined DSCP values to apply or select User Define to specify another DSCP value. The "af" choices stand for Assured Forwarding. The number following the "af" identifies one of four classes and one of three drop preferences. See Assured Forwarding (AF) PHB for DiffServ for more details.</p> <p>Select preserve to have the Zyxel Device keep the packets' original DSCP value.</p> <p>Select default to have the Zyxel Device set the DSCP value of the packets to 0.</p>
User-Defined DSCP Marking	Use this field to specify a custom DSCP value.
Address Translation	Use this section to configure NAT for the policy route. This section does not apply to policy routes that use a VPN tunnel as the next hop.
Source Network Address Translation	<p>Select none to not use NAT for the route.</p> <p>Select outgoing-interface to use the IP address of the outgoing interface as the source IP address of the packets that matches this route.</p> <p>To use SNAT for a virtual interface that is in the same WAN trunk as the physical interface to which the virtual interface is bound, the virtual interface and physical interface must be in different subnets.</p> <p>Otherwise, select a pre-defined address (group) to use as the source IP address(es) of the packets that match this route.</p>
Apply	Click Apply to save your changes back to the Zyxel Device.
Cancel	Click Cancel to return the screen to its last-saved settings.

8.3 Static Route Screen

Click **Network > Routing > Static Route** to open the **Static Route** screen. This screen displays the configured static routes.

Figure 118 Network > Routing > Static Route

Name	Destination	Next Hop	Description	Metric
Cathy	0.0.0.0/1	1.1.1.1		0

The following table describes the labels in this screen.

Table 78 Network > Routing > Static Route

LABEL	DESCRIPTION
Add	Click this to create a new static route.
Edit	Double-click an entry or select it and click Edit to open a screen where you can modify the entry's settings.

Table 78 Network > Routing > Static Route (continued)

LABEL	DESCRIPTION
Remove	To remove an entry, select it and click Remove . The Zyxel Device confirms you want to remove it before doing so.
Name	This is the name of the static route entry.
Destination	This is the destination IP address.
Next-Hop	This is the IP address of the next-hop gateway or the interface through which the traffic is routed. The gateway is a router or switch on the same segment as your Zyxel Device's interface(s). The gateway helps forward packets to their destinations.
Metric	This is the route's priority among the Zyxel Device's routes. The smaller the number, the higher priority the route has.

8.3.1 Static Route Add/Edit Screen

Click **Network > Routing > Static Route > Add/Edit** to display the next screen. Use this screen to configure the required information for a static route.

Figure 119 Network > Routing > Static Route > Add

The screenshot shows the configuration page for adding a static route. The breadcrumb navigation is Network > Routing > Static Route. The configuration fields are as follows:

- Name:** A text input field with an error message: "The value in this field is invalid. It must begin with a letter and cannot exceed 31 characters. The valid characters are [0-9][a-z][A-Z][-].".
- Description:** A text input field.
- Destination:** A dropdown menu showing "user defined" with a pencil icon, and a text input field with an error message: "It should be an IPv4 CIDR notation (for example: 192.168.0.0/16)".
- Next Hop:** Three radio buttons: "Gateway" (selected), "Gateway Object", and "Interface". Below them is a text input field with an error message: "The value should be an IP address".
- Metric:** A text input field containing the value "0".

In the bottom right corner, there is a green confirmation box that says "Some changes were made. What do you want to do then?" with "Cancel" and "Apply" buttons.

The following table describes the labels in this screen.

Table 79 Network > Routing > Static Route > Add

LABEL	DESCRIPTION
Name	Enter a name to identify this rule. You can use up to 30 single-byte characters, including 0-9a-zA-Z. The first character cannot be a number.
Destination	This parameter specifies the IP network address of the final destination. Routing is always based on network number. If you need to specify a route to a single host, enter the specific IP address here.
Next Hop	
Gateway	Select the radio button and enter the IP address of the next-hop gateway. The gateway is a router or switch on the same segment as your Zyxel Device's interface(s). The gateway helps forward packets to their destinations.
Gateway Object	Select the radio button to route the matched IPv6 packets through a 6to4 tunnel to the packets' destination.

Table 79 Network > Routing > Static Route > Add (continued)

LABEL	DESCRIPTION
Interface	Select the radio button and a predefined interface through which the traffic is sent.
Metric	Metric represents the "cost" of transmission for routing purposes. IP routing uses hop count as the measurement of cost, with a minimum of 1 for directly connected networks. Enter a number that approximates the cost for this link. The number need not be precise, but it must be 0~127. In practice, 2 or 3 is usually a good number.
Apply	Click Apply to save your changes back to the Zyxel Device.
Cancel	Click Cancel to return the screen to its last-saved settings.

CHAPTER 9

NAT

9.1 NAT Overview

NAT (Network Address Translation - NAT, RFC 1631) is the translation of the IP address of a host in a packet. For example, the source address of an outgoing packet, used within one network is changed to a different IP address known within another network. Use Network Address Translation (NAT) to make computers on a private network behind the Zyxel Device available outside the private network. If the Zyxel Device has only one public IP address, you can make the computers in the private network available by using ports to forward packets to the appropriate private IP address.

Suppose you want to assign ports 21-25 to one FTP, Telnet and SMTP server (**A** in the example), port 80 to another (**B** in the example) and assign a default server IP address of 192.168.1.35 to a third (**C** in the example). You assign the LAN IP addresses and the ISP assigns the WAN IP address. The NAT network appears as a single host on the Internet.

Figure 120 Multiple Servers Behind NAT Example

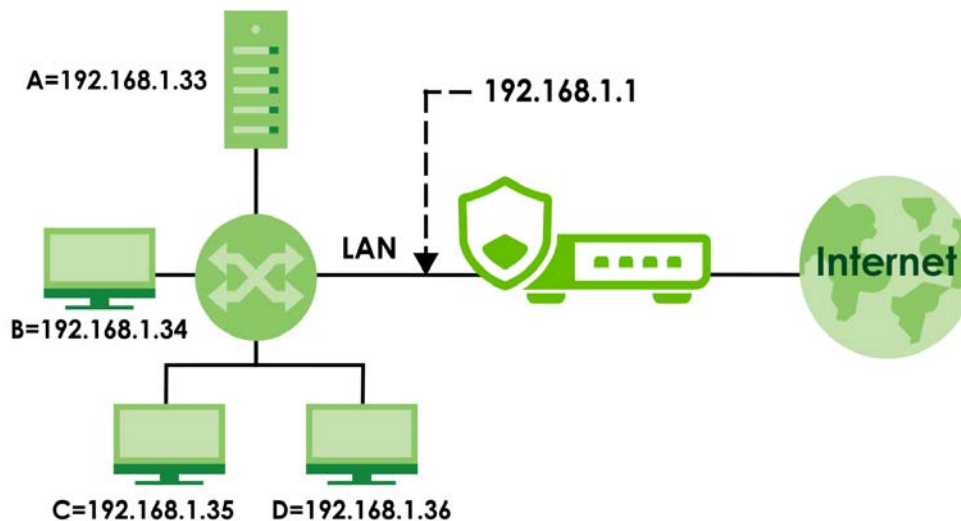

9.1.1 What You Can Do in this Chapter

Use the **NAT** screens (see [Section 9.2 on page 166](#)) to view and manage the list of NAT rules and see their configuration details. You can also create new NAT rules and edit or delete existing ones.

9.1.2 What You Need to Know

NAT is also known as virtual server, port forwarding, or port translation.

Well-known Ports

Port numbers range from 0 to 65535, but only port numbers 0 to 1023 are reserved for privileged services and designated as well-known ports. The following list specifies the ports used by the server process as its contact ports. See [Section 15.2 on page 266 \(Object > Service\)](#) for more information about service objects.

- Well-known ports range from 0 to 1023.
- Registered ports range from 1024 to 49151.
- Dynamic ports (also called private ports) range from 49152 to 65535.

Table 80 Well-known Ports

PORT	TCP/UDP	DESCRIPTION
1	TCP	TCP Port Service Multiplexer (TCPMUX)
20	TCP	FTP - Data
21	TCP	FTP - Control
22	TCP	SSH Remote Login Protocol
23	TCP	Telnet
25	TCP	Simple Mail Transfer Protocol (SMTP)
42	UDP	Host Name Server (Nameserv)
43	TCP	Whols
53	TCP/UDP	Domain Name System (DNS)
67	UDP	BOOTP/DHCP server
68	UDP	BOOTP/DHCP client
69	UDP	Trivial File Transfer Protocol (TFTP)
79	TCP	Finger
80	TCP	HTTP
110	TCP	POP3
119	TCP	Newsgroup (NNTP)
123	UDP	Network Time Protocol (NTP)
135	TCP/UDP	RPC Locator service
137	TCP/UDP	NetBIOS Name Service
138	UDP	NetBIOS Datagram Service
139	TCP	NetBIOS Datagram Service
143	TCP	Interim Mail Access Protocol (IMAP)
161	UDP	SNMP
179	TCP	Border Gateway Protocol (BGP)
389	TCP/UDP	Lightweight Directory Access Protocol (LDAP)
443	TCP	HTTPS
445	TCP	Microsoft - DS
636	TCP	LDAP over TLS/SSL (LDAPS)
953	TCP	BIND DNS
990	TCP	FTP over TLS/SSL (FTPS)
995	TCP	POP3 over TLS/SSL (POP3S)

NAT Loopback

Suppose an NAT 1:1 rule maps a public IP address to the private IP address of a LAN SMTP email server to give WAN users access. NAT loopback allows other users to also use the rule's original IP to access the mail server.

For example, a LAN user's computer at IP address 192.168.1.89 queries a public DNS server to resolve the SMTP server's domain name (xxx.LAN-SMTP.com in this example) and gets the SMTP server's mapped public IP address of 1.1.1.1.

Figure 121 LAN Computer Queries a Public DNS Server

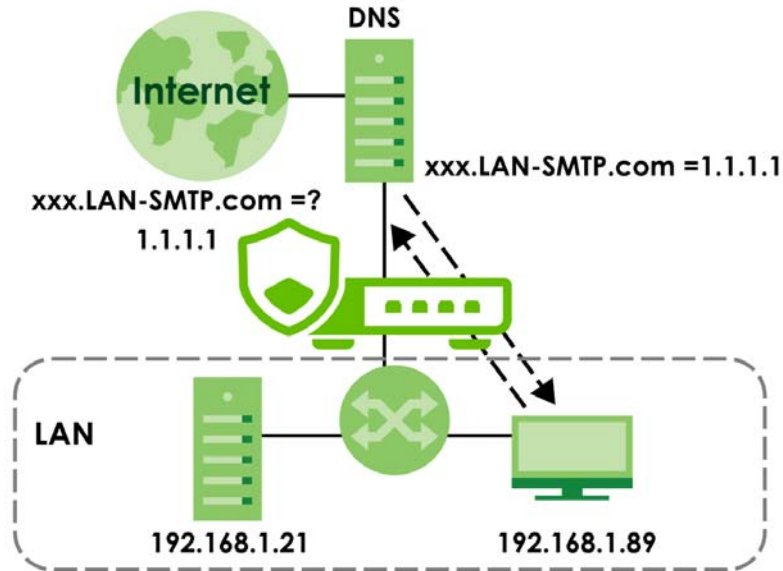

The LAN user's computer then sends traffic to IP address 1.1.1.1. NAT loopback uses the IP address of the Zyxel Device's LAN interface (192.168.1.1) as the source address of the traffic going from the LAN users to the LAN SMTP server.

Figure 122 LAN to LAN Traffic

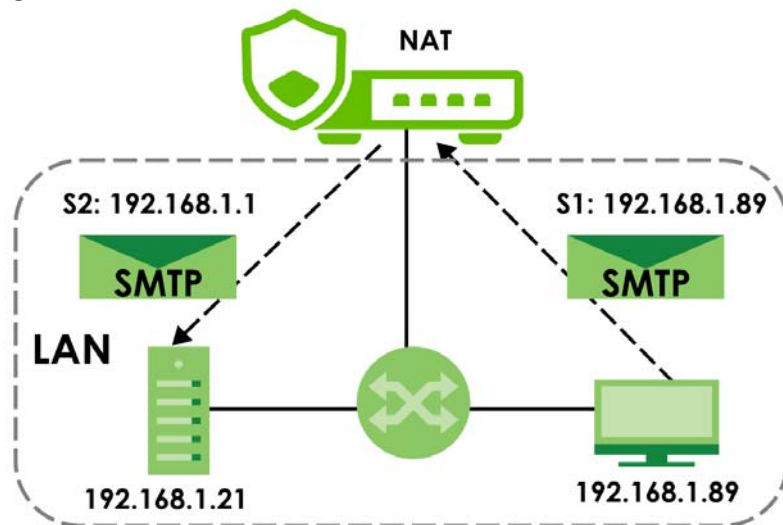

The LAN SMTP server replies to the Zyxel Device's LAN IP address and the Zyxel Device changes the source address to 1.1.1.1 before sending it to the LAN user. The return traffic's source matches the original destination address (1.1.1.1). If the SMTP server replied directly to the LAN user without the traffic going through NAT, the source would not match the original destination address which would cause the LAN user's computer to shut down the session.

Figure 123 LAN to LAN Return Traffic

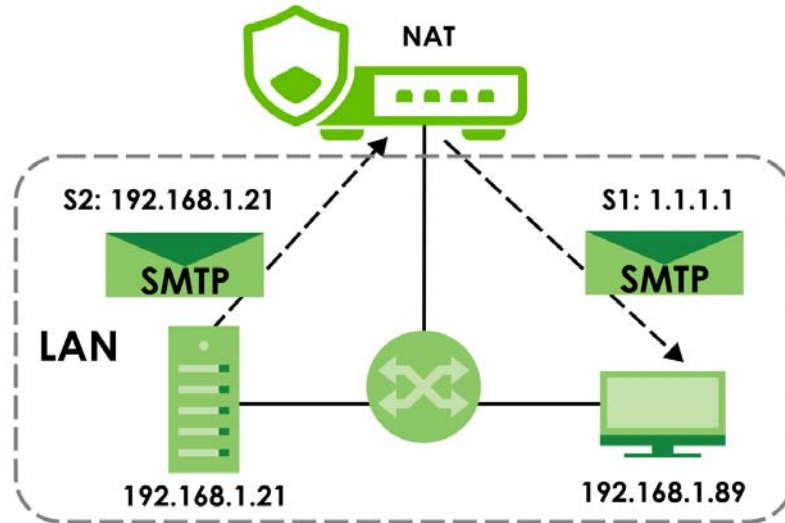

9.2 The NAT Screen

The **NAT** summary screen provides a summary of all NAT rules and their configuration. In addition, this screen allows you to create new NAT rules and edit and delete existing NAT rules. To access this screen, login to the Web Configurator and click **Network** > **NAT**. The following screen appears, providing a summary of the existing NAT rules.

Figure 124 Network > NAT

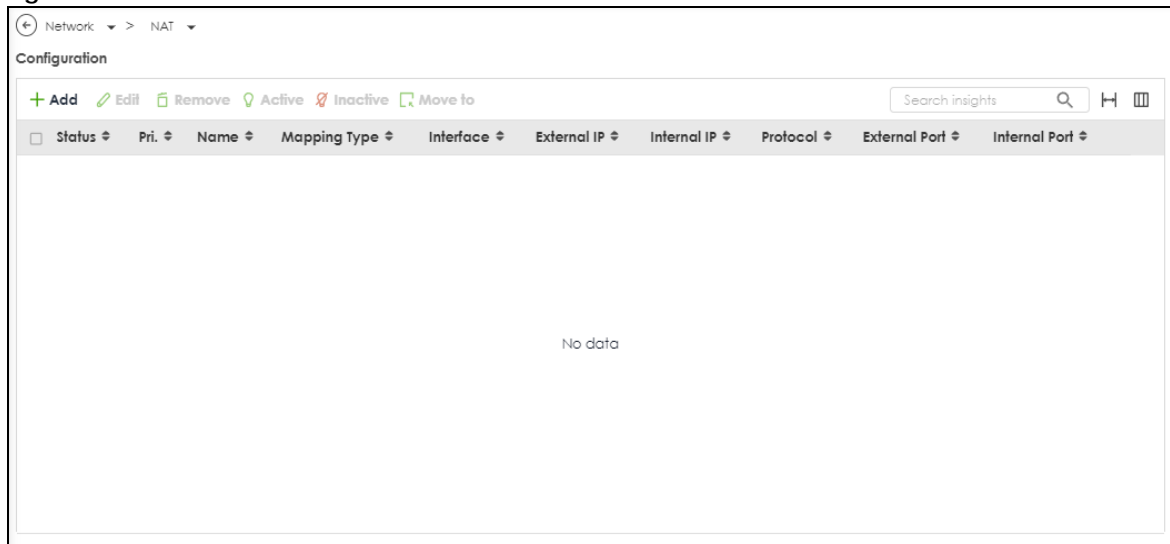

The following table describes the labels in this screen.

Table 81 Network > NAT

LABEL	DESCRIPTION
Add	Click this to create a new entry.
Edit	Double-click an entry or select it and click Edit to open a screen where you can modify the entry's settings.
Remove	To remove an entry, select it and click Remove . The Zyxel Device confirms you want to remove it before doing so.
Activate	To turn on an entry, select it and click Activate .
Inactivate	To turn off an entry, select it and click Inactivate .
Move	To change a rule's position in the numbered list, select the rule and click Move to display a field to type a number for where you want to put that rule and press [ENTER] to move the rule to the number that you typed. The ordering of your rules is important as they are applied in order of their numbering.
Status	This icon is lit when the entry is active and dimmed when the entry is inactive.
Priority	This field displays the priority for the entry. The smaller the number, the higher the priority.
Name	This field displays the name of the entry.
Mapping Type	This field displays what kind of NAT this entry performs: Virtual Server , 1:1 NAT , or Many 1:1 NAT .
Interface	This field displays the interface on which packets for the NAT entry are received.
Source IP	This field displays the source IP address (or address object) of traffic that matches this NAT entry. It displays any if there is no restriction on the source IP address.
External IP	This field displays the original destination IP address (or address object) of traffic that matches this NAT entry. It displays any if there is no restriction on the original destination IP address.
Internal IP	This field displays the new destination IP address for the packet.
Protocol	This field displays the service used by the packets for this NAT entry. It displays any if there is no restriction on the services.
External Port	This field displays the original destination port(s) of packets for the NAT entry. This field is blank if there is no restriction on the original destination port.
Internal Port	This field displays the new destination port(s) for the packet. This field is blank if there is no restriction on the original destination port.
Apply	Click Apply to save your changes to the Zyxel Device.
Cancel	Click Cancel to return the screen to its last-saved settings.

9.2.1 The NAT Add/Edit Screen

The **NAT Add/Edit** screen lets you create new NAT rules and edit existing ones. To open this window, open the **NAT** summary screen. (See [Section 9.2 on page 166](#).) Then, click on an **Add** icon or **Edit** icon to open the following screen.

Figure 125 Network > NAT > Add

The following table describes the labels in this screen.

Table 82 Network > NAT > Add

LABEL	DESCRIPTION
Enable Rule	Use this option to turn the NAT rule on or off.
Rule Name	Type in the name of the NAT rule. The name is used to refer to the NAT rule. You may use 1-31 alphanumeric characters, underscores(_), or dashes (-), but the first character cannot be a number. This value is case-sensitive.
Classification	Select what kind of NAT this rule is to perform. Virtual Server - This makes computers on a private network behind the Zyxel Device available to a public network outside the Zyxel Device (like the Internet). 1:1 NAT - If the private network server will initiate sessions to the outside clients, select this to have the Zyxel Device translate the source IP address of the server's outgoing traffic to the same public IP address that the outside clients use to access the server. Many 1:1 NAT - If you have a range of private network servers that will initiate sessions to the outside clients and a range of public IP addresses, select this to have the Zyxel Device translate the source IP address of each server's outgoing traffic to the same one of the public IP addresses that the outside clients use to access the server. The private and public ranges must have the same number of IP addresses. One many 1:1 NAT rule works like multiple 1:1 NAT rules, but it eases configuration effort since you only create one rule.
Incoming Interface	Select the interface on which packets for the NAT rule must be received. It can be an Ethernet, VLAN or bridge interface.

Table 82 Network > NAT > Add (continued)

LABEL	DESCRIPTION
Source IP	<p>Specify the source IP address of the packets received by this NAT rule's specified incoming interface.</p> <p>any - Select this to use all of the incoming interface's IP addresses including dynamic addresses or those of any virtual interfaces built upon the selected incoming interface.</p> <p>User Defined - Select this to manually enter an IP address in the User Defined field. For example, you could enter a static IP address.</p> <p>Host address - select a address object to use the IP address it specifies.</p>
External IP	<p>Specify the destination IP address of the packets received by this NAT rule's specified incoming interface. The specified IP address will be translated to the Internal IP address.</p> <p>any - Select this to use all of the incoming interface's IP addresses including dynamic addresses or those of any virtual interfaces built upon the selected incoming interface.</p> <p>User Defined - Select this to manually enter an IP address in the User Defined field. For example, you could enter a static public IP assigned by the ISP without having to create a virtual interface for it.</p> <p>Host address - select a host address object to use the IP address it specifies. The list also includes address objects based on interface IPs. So for example you could select an address object based on a WAN interface even if it has a dynamic IP address.</p>
Internal IP	<p>Select to which translated destination IP address this NAT rule forwards packets.</p> <p>User Defined - this NAT rule supports a specific IP address, specified in the User Defined field.</p> <p>HOST address - the drop-down box lists all the HOST address objects in the Zyxel Device. If you select one of them, this NAT rule supports the IP address specified by the address object.</p>
External IP Subnet/Range	<p>This field displays for Many 1:1 NAT. Select the destination IP address subnet or IP address range that this NAT rule supports. The original and mapped IP address subnets or ranges must have the same number of IP addresses.</p>
Internal IP Subnet/Range	<p>This field displays for Many 1:1 NAT. Select to which translated destination IP address subnet or IP address range this NAT rule forwards packets. The original and mapped IP address subnets or ranges must have the same number of IP addresses.</p>
Port Mapping Type	<p>Use the drop-down list box to select how many original destination ports this NAT rule supports for the selected destination IP address (Original IP). Choices are:</p> <p>any - this NAT rule supports all the destination ports.</p> <p>Port - this NAT rule supports one destination port.</p> <p>Ports - this NAT rule supports a range of destination ports. You might use a range of destination ports for unknown services or when one server supports more than one service.</p> <p>Service - this NAT rule supports a service such as FTP (see Object > Service > Service)</p> <p>service-group - this NAT rule supports a group of services such as all service objects related to DNS (see Object > Service > Service Group)</p>
Protocol Type	<p>This field is available if Mapping Type is Port or Ports. Select the protocol (TCP, UDP, or Any) used by the service requesting the connection.</p>
External Port	<p>This field is available if Mapping Type is Port. Enter the external destination port this NAT rule supports.</p>
Internal Port	<p>This field is available if Mapping Type is Port. Enter the translated destination port if this NAT rule forwards the packet.</p>
External Start Port	<p>This field is available if Mapping Type is Ports. Enter the beginning of the range of original destination ports this NAT rule supports.</p>
External End Port	<p>This field is available if Mapping Type is Ports. Enter the end of the range of original destination ports this NAT rule supports.</p>

Table 82 Network > NAT > Add (continued)

LABEL	DESCRIPTION
Internal Start Port	This field is available if Mapping Type is Ports . Enter the beginning of the range of translated destination ports if this NAT rule forwards the packet.
Internal End Port	This field is available if Mapping Type is Ports . Enter the end of the range of translated destination ports if this NAT rule forwards the packet. The original port range and the mapped port range must be the same size.
Enable NAT Loopback	<p>Enable NAT loopback to allow users connected to any interface (instead of just the specified Incoming Interface) to use the NAT rule's specified External IP address to access the Internal IP device. For users connected to the same interface as the Internal IP device, the Zyxel Device uses that interface's IP address as the source address for the traffic it sends from the users to the Internal IP device.</p> <p>For example, if you configure a NAT rule to forward traffic from the WAN to a LAN server, enabling NAT loopback allows users connected to other interfaces to also access the server. For LAN users, the Zyxel Device uses the LAN interface's IP address as the source address for the traffic it sends to the LAN server. See NAT Loopback on page 165 for more details.</p> <p>If you do not enable NAT loopback, this NAT rule only applies to packets received on the rule's specified incoming interface.</p>
Security Policy	<p>By default the security policy blocks incoming connections from external addresses. After you configure your NAT rule settings, click the Security Policy link to configure a security policy to allow the NAT rule's traffic to come in.</p> <p>The Zyxel Device checks NAT rules before it applies To-Zyxel Device security policies, so To-Zyxel Device security policies, do not apply to traffic that is forwarded by NAT rules. The Zyxel Device still checks other security policies, according to the source IP address and mapped IP address.</p>
Apply	Click Apply to save your changes to the Zyxel Device.
Cancel	Click Cancel to return the screen to its last-saved settings.

Note: If you set the **User-Defined External IP** to the IP address of the web configurator and set the **External Port** to 80 or 443, this rule will conflict with the Zyxel Device's default HTTP server port.

A warning message will pop out when you click **OK**. If you click **No** in the warning message, the rule will apply to the Zyxel Device. You will not be able to access the web configurator through this interface.

CHAPTER 10

BWM (Bandwidth Management)

10.1 Overview

Bandwidth management provides a convenient way to manage the use of various services on the network. It manages general protocols (for example, HTTP and FTP) and applies traffic prioritization to enhance the performance of delay-sensitive applications like voice and video.

10.1.1 What You Can Do in this Chapter

Use the **BWM** screens (see [Section 10.2 on page 173](#)) to control bandwidth for services passing through the Zyxel Device, and to identify the conditions that define the bandwidth control.

10.1.2 What You Need to Know

When you allow a service, you can restrict the bandwidth it uses. It controls TCP and UDP traffic. Use policy routes to manage other types of traffic (like ICMP).

Note: Bandwidth management in policy routes has priority over TCP and UDP traffic policies.

If you want to use a service, make sure both the security policy allow the service's packets to go through the Zyxel Device.

Note: The Zyxel Device checks security policies before it checks bandwidth management rules for traffic going through the Zyxel Device.

Bandwidth management examines every TCP and UDP connection passing through the Zyxel Device. Then, you can specify, by port, whether or not the Zyxel Device continues to route the connection.

Connection and Packet Directions

Bandwidth management looks at the connection direction, that is, from which interface the connection was initiated and to which interface the connection is going.

A connection has upload and download packet flows. The Zyxel Device controls the bandwidth of traffic of each flow as it is going out through an interface or IPsec VPN tunnel.

- The upload traffic flows from the connection initiator to the connection responder.
- The download traffic flows from the connection responder to the connection initiator.

For example, a LAN1 to WAN connection is initiated from LAN1 and goes to the WAN.

- Upload traffic goes from a LAN1 device to a WAN device. Bandwidth management is applied before sending the packets out a WAN interface on the Zyxel Device.
- Download traffic comes back from the WAN device to the LAN1 device. Bandwidth management is applied before sending the traffic out a LAN1 interface.

Figure 126 LAN1 to WAN Connection and Packet Directions

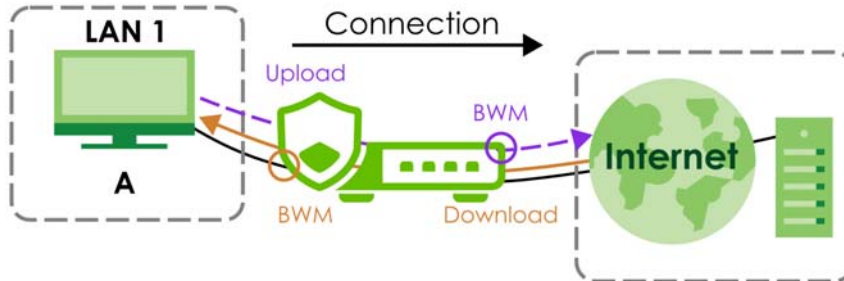

Upload and Download Bandwidth Limits

You can limit an application's upload or download bandwidth. This limit keeps the traffic from using up too much of the upload interface's bandwidth. This way you can make sure there is bandwidth for other applications. When you apply a bandwidth limit to upload or download traffic, each member of the upload zone can send up to the limit. Take a LAN1 to WAN policy for example.

- Upload traffic is limited to 200 kbps. The connection initiator is on the LAN1 so upload means the traffic traveling from the LAN1 to the WAN. Each of the WAN zone's two interfaces can send the limit of 200 kbps of traffic.
- Download traffic is limited to 500 kbps. The connection initiator is on the LAN1 so download means the traffic traveling from the WAN to the LAN1.

Figure 127 LAN1 to WAN, Upload 200 kbps, Download 500 kbps

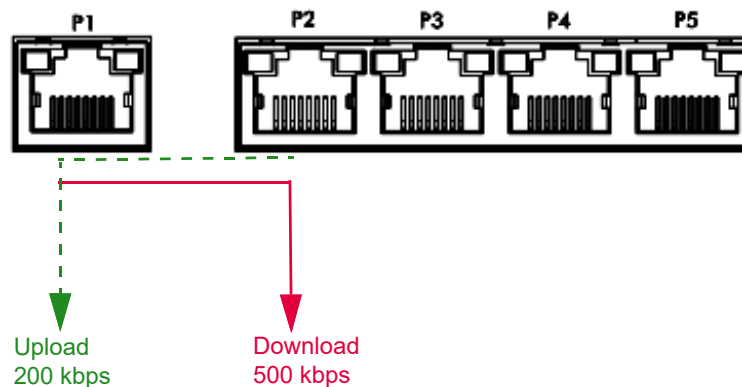

Bandwidth Management Priority

- The Zyxel Device gives bandwidth to higher-priority traffic first, until it reaches its configured bandwidth rate.
- Then lower-priority traffic gets bandwidth.
- The Zyxel Device uses a priority queueing scheduler to divide bandwidth among traffic flows with the same priority.
- The Zyxel Device automatically treats traffic with bandwidth management disabled as priority 7 (the lowest priority).

Configured Rate Effect

In the following table the configured rates total less than the available bandwidth and maximize bandwidth usage is disabled, both servers get their configured rate.

Table 83 Configured Rate Effect

POLICY	CONFIGURED RATE	MAX. BANDWIDTH USAGE	PRIORITY	ACTUAL RATE
A	300 kbps	No	1	300 kbps
B	200 kbps	No	1	200 kbps

Priority and Over Allotment of Bandwidth Effect

Server A has a configured rate that equals the total amount of available bandwidth and a higher priority. You should regard extreme over allotment of traffic with different priorities (as shown here) as a configuration error. Even though the Zyxel Device still attempts to let all traffic get through and not be lost, regardless of its priority, server B gets almost no bandwidth with this configuration.

Table 84 Priority and Over Allotment of Bandwidth Effect

POLICY	CONFIGURED RATE	MAX. BANDWIDTH USAGE	PRIORITY	ACTUAL RATE
A	1000 kbps	Yes	1	999 kbps
B	1000 kbps	Yes	2	1 kbps

Limit the Bandwidth for a Specific VLAN

If you want to limit the bandwidth for a specific VLAN, set the VLAN as the incoming interface and VPN as the outgoing interface. Then, set the bandwidth limit for this BWM rule.

10.2 The Bandwidth Management Configuration

The Bandwidth management screens control the bandwidth allocation for TCP and UDP traffic. You can use incoming interface, outgoing interface, user, source, destination information, application, and service type as criteria to create a sequence of specific conditions, similar to the sequence of rules used by firewalls, to specify how the Zyxel Device allocates bandwidth for the matching packets.

Click **Network > BWM** to open the following screen. This screen allows you to enable/disable bandwidth management and add, edit, and remove user-defined bandwidth management policies.

The default bandwidth management policy is the one with the priority of "default". It is the last policy the Zyxel Device checks if traffic does not match any other bandwidth management policies you have configured. You cannot remove, activate, deactivate or move the default bandwidth management policy.

Figure 128 Network > Bandwidth Management

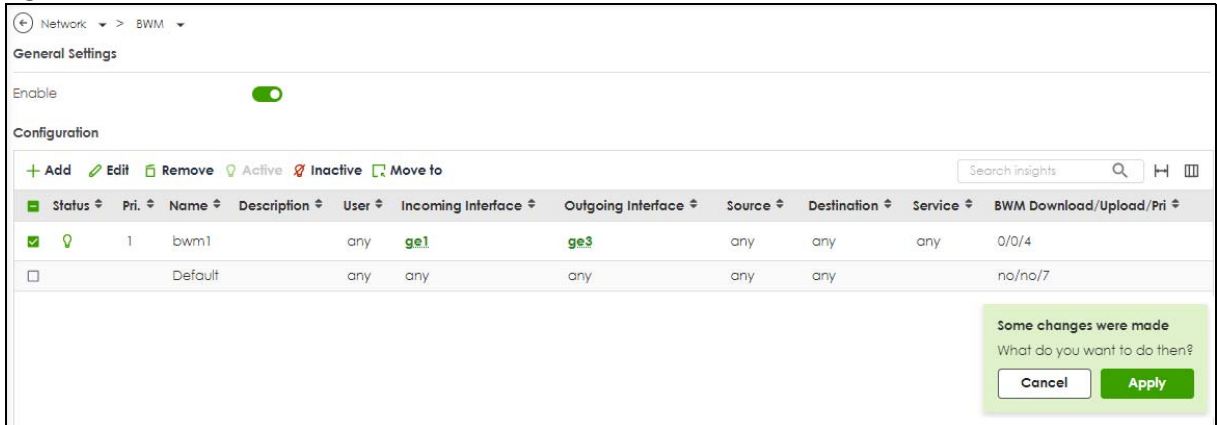

The following table describes the labels in this screen. See [Section 10.2.1 on page 175](#) for more information as well.

Table 85 Network > Bandwidth Management

LABEL	DESCRIPTION
Enable	Click to slide the switch to the right to activate bandwidth management on the Zyxel Device.
Add	Click this to create a new entry. Select an entry and click Add to create a new entry after the selected entry.
Edit	Select an entry and click this to be able to modify it.
Remove	Select an entry and click this to delete it.
Activate	To turn on an entry, select it and click Activate .
Inactivate	To turn off an entry, select it and click Inactivate .
Move to	To change an entry's position in the numbered list, select it and click Move to display a field to type a number for where you want to put that entry and press [ENTER] to move the entry to the number that you typed.
Status	The activate (light bulb) icon is lit when the entry is active and dimmed when the entry is inactive. The status icon is not available for the default bandwidth management policy.
Pri (Priority)	This field displays a sequential value for each bandwidth management policy and it is not associated with a specific setting. This field displays default for the default bandwidth management policy.
Name	This is the name of the BWM rule.
Description	This field displays additional information about this policy.
User	This is the type of user account to which the policy applies. If any displays, the policy applies to all user accounts.
Incoming Interface	This is the source interface of the traffic to which this policy applies.
Outgoing Interface	This is the destination interface of the traffic to which this policy applies.
Source	This is the source address or address group, including geographic address and FQDN (group) objects, for whom this policy applies. If any displays, the policy is effective for every source.
Destination	This is the destination address or address group, including geographic address and FQDN (group) objects, for whom this policy applies. If any displays, the policy is effective for every destination.

Table 85 Network > Bandwidth Management (continued)

LABEL	DESCRIPTION
Service	<p>App and the service name displays if you selected Application Object for the service type. An Application Object is a pre-defined service.</p> <p>Obj and the service name displays if you selected Service Object for the service type. A Service Object is a customized pre-defined service or another service. Mouse over the service object name to view the corresponding IP protocol number.</p>
BWM Download/ Upload/Pri	<p>This field shows the amount of bandwidth the traffic can use.</p> <p>Download - This is how much inbound bandwidth, in megabits per second, this policy allows the matching traffic to use. Inbound refers to the traffic the Zyxel Device sends to a connection's initiator. If 0 displays here, it means the download traffic has reached the maximum capacity the Zyxel Device can transmit.</p> <p>Upload - This is how much outbound bandwidth, in megabits per second, this policy allows the matching traffic to use. Outbound refers to the traffic the Zyxel Device sends out from a connection's initiator. If 0 displays here, it means the upload traffic has reached the maximum capacity the Zyxel Device can transmit.</p> <p>Pri - This is the priority for the inbound or outbound traffic that matches this policy. The smaller the number, the higher the priority. Traffic with a higher priority is given bandwidth before traffic with a lower priority.</p>
Apply	Click Apply to save your changes back to the Zyxel Device.
Cancel	Click Cancel to return the screen to its last-saved settings.

10.2.1 The Bandwidth Management Add/Edit Screen

The **Network > BWM > Add/Edit** screen allows you to create a new condition or edit an existing one.

To access this screen, go to the **Network > BWM** screen (see [Section 10.2 on page 173](#)), and click either the **Add** icon or an **Edit** icon.

Figure 129 Network > BWM > Edit (For the Default Policy)

The screenshot shows a web interface for editing a BWM policy. At the top, there is a breadcrumb navigation: 'Network > BWM'. Below this is a 'Configuration' section with a 'Name' field containing the text 'Default'. Underneath is a 'Traffic Shaping' section with a 'Priority' dropdown menu currently set to 'Lowest(7)'. The interface is clean and uses a light gray color scheme.

Figure 130 Network > BWM > Add/Edit

Network > BWM

Configuration

Name: bwm1

Description:

Criteria

Incoming Interface: ge1 (WAN)

Outgoing Interface: ge3 (LAN)

Source: any

Destination: any

Service Type: Service Object Application Group

Service Object: any

User: any

Traffic Shaping

Download Limit: Unlimited Limit 0 Mbps

Upload Limit: Unlimited Limit 0 Mbps

Priority: Medium(4)

Related Setting

Log: log

The following table describes the labels in this screen.

Table 86 Network > BWM > Add/Edit

LABEL	DESCRIPTION
Configuration	
Enable	Select this check box to turn on this policy.
Name	Enter a name to identify the BWM rule. You may use 1-31 alphanumeric characters, underscores (_), or dashes (-), but the first character cannot be a number. This value is case-sensitive.
Description	Enter a description of this policy. It is not used elsewhere. You can use alphanumeric and ()+/:?!*#@\$_%- characters, and it can be up to 60 characters long.
Criteria	Use this section to configure the conditions of traffic to which this policy applies.
Incoming Interface	Select the source interface of the traffic to which this policy applies.
Outgoing Interface	Select the destination interface of the traffic to which this policy applies.
Source	Select a source address or address group, including geographic address and FQDN (group) objects, for whom this policy applies. Use Create new Object if you need to configure a new one. Select any if the policy is effective for every source.
Destination	Select a destination address or address group, including geographic address and FQDN (group) objects, for whom this policy applies. Use Create new Object if you need to configure a new one. Select any if the policy is effective for every destination.

Table 86 Network > BWM > Add/Edit (continued)

LABEL	DESCRIPTION
Service Type	Select Service Object or Application Group if you want a specific service (defined in a service object) or application patrol service to which the policy applies.
Service Object	This field is available if you selected Service Object as the service type. Select a service or service group to identify the type of traffic to which this policy applies. any means all services.
Application Group	This field is available if you selected Application Group as the service type. Select an application to identify the specific traffic to which this policy applies. If you select BitTorrent , it includes the services listed below at the time of writing: <ul style="list-style-type: none"> • BitTorrent • BitTorrent_FileTransfer • BitTorrent_Application • BitTorrent_Bundle
User	Select a user name or user group to which to apply the policy. Use Create new Object if you need to configure a new user account. Select any to apply the policy for every user.
Traffic Shaping	Configure these fields to set the amount of bandwidth the matching traffic can use.
Download Limit Mbps	Type how much inbound bandwidth, in megabits per second, this policy allows the traffic to use. Inbound refers to the traffic the Zyxel Device sends to a connection's initiator. Select Unlimited to apply bandwidth management for the matching traffic which is the maximum amount your Zyxel Device can transmit. Select Limited to apply bandwidth management for matching traffic, and enter a number from 1 to 10,000 Mbps. Note: Traffic matching a Limited policy may "borrow" all unused bandwidth on the inbound interface. If the sum of the bandwidths for routes using the same next hop is higher than the actual transmission speed, lower priority traffic may not be sent if higher priority traffic uses all of the actual bandwidth.
Upload Limit Mbps	Type how much outbound bandwidth, in megabits per second, this policy allows the traffic to use. Outbound refers to the traffic the Zyxel Device sends out from a connection's initiator. Select Unlimited to apply bandwidth management for the matching traffic which is the maximum amount your Zyxel Device can transmit. Select Limited to apply bandwidth management for matching traffic, and enter a number from 1 to 10,000 Mbps. Note: Traffic matching a Limited policy may "borrow" all unused bandwidth on the upload interface. If the sum of the bandwidths for routes using the same next hop is higher than the actual transmission speed, lower priority traffic may not be sent if higher priority traffic uses all of the actual bandwidth.

Table 86 Network > BWM > Add/Edit (continued)

LABEL	DESCRIPTION
Priority	<p>Choose a number between 0 and 7 to set the priority for traffic that matches this policy. The smaller the number, the higher the priority. 0 is for real-time traffic such as video, and 7 is for lowest priority traffic such as background traffic.</p> <p>Traffic with a higher priority is given bandwidth before traffic with a lower priority. When traffic with higher priority has reached the full bandwidth, the traffic with lower priority can use the remaining bandwidth.</p> <p>The Zyxel Device uses priority queueing scheduler to divide bandwidth between traffic flows with the same priority.</p> <p>The number in this field is ignored if the download and upload limits are both set to Unlimited.</p>
Related Setting	
Log	Select whether to have the Zyxel Device generate a log (log), log and alert (log alert) or neither (no) when any traffic matches this policy.
Apply	Click Apply to save your changes back to the Zyxel Device.
Cancel	Click Cancel to return the screen to its last-saved settings.

10.2.2 Adding Objects for the BWM Policy

Objects are parameters to which the Policy rules are built upon. You can add/edit **User** and **Address** objects for the BWM policy. Click **Network > BWM > Add > Create New Object > Add User** to see the following screen.

10.2.2.1 User Objects

Figure 131 Network > BWM > Create New Object > Add User

The following table describes the fields in the above screen.

Table 87 Network > BWM > Create New Object > Add User

LABEL	DESCRIPTION
User Name	Type a user or user group object name of the rule.
User Type	Select a user type from the drop down menu. The user types are Admin, Limited admin, User, Guest, Ext-user, Ext-group-user.
Password	Type a password for the user object. The password can consist of alphanumeric characters, the underscore, and some punctuation marks (+-/*=:;!@\$\$%#~' \ ()), and it can be up to eight characters long.
Retype	Retype the password to confirm.

Table 87 Network > BWM > Create New Object > Add User (continued)

LABEL	DESCRIPTION
Description	Enter a description of this policy. It is not used elsewhere. You can use alphanumeric and ()+/:+?!*#@\$_%- characters, and it can be up to 60 characters long.
Save	Click Save to save the setting.
Cancel	Click Cancel to return the screen to its last-saved settings.

10.2.2.2 User Group Objects

Figure 132 Network > BWM > Create New Object > Add User Group

The following table describes the fields in the above screen.

Table 88 Network > BWM > Create New Object > Add User Group

LABEL	DESCRIPTION
Name	Type a user group name of the object.
Description	Enter a description of this policy. It is not used elsewhere. You can use alphanumeric and ()+/:+?!*#@\$_%- characters, and it can be up to 60 characters long.
Member List	Select the users or user groups that will be in this user group.
Save	Click Save to save the setting.
Cancel	Click Cancel to return the screen to its last-saved settings.

10.2.2.3 Address Objects

Figure 133 Network > BWM > Create New Object > Add Address

The following table describes the fields in the above screen.

Table 89 Network > BWM > Create New Object > Add Address

LABEL	DESCRIPTION
Name	Enter a name for the Address object of the rule.
Address Type	Select an Address Type from the drop down menu on the right. The Address Types are Host , Range , Subnet , Interface IP , Interface Subnet , and Interface Gateway .
IP Address	Enter an IP address for the Address object.
Save	Click Save to save the setting.
Cancel	Click Cancel to return the screen to its last-saved settings.

10.2.2.4 Address Group Objects

Figure 134 Network > BWM > Create New Object > Add Address Group

The following table describes the fields in the above screen.

Table 90 Network > BWM > Create New Object > Add Address Group

LABEL	DESCRIPTION
Name	Type an address group name of the object.
Description	Enter a description of this object. It is not used elsewhere. You can use alphanumeric and ()+/:+?!*#@\$_%- characters, and it can be up to 60 characters long.
Member List	Select the address objects that will be in this user group.
Save	Click Save to save the setting.
Cancel	Click Cancel to return the screen to its last-saved settings.

10.3 Example: Prioritize a Specific Application

You are a client on the Zyxel Device LAN. You use Teams to communicate with your colleagues and have video meetings often at work. You want to create a bandwidth management rule to prioritize traffic for Teams so that you can always use Teams without any delay.

This example uses the parameters given below.

Table 91 BWM Example

DESCRIPTION	SERVICE TYPE	SERVICE OBJECT	GUARANTEED BANDWIDTH
Teams	Application Group	Teams	Download 20 mbps/ Priority: 1 Upload: 20 mbps/ Priority: 1

- 1 Go to **Network > BWM** . Click **Add** to create a bandwidth management rule using the parameters given in [Table 91 on page 181](#).
- 2 Select **Teams** under **Application Group**.
- 3 Click **Apply** to save your changes.

Configuration

Enable

Name

Description

Criteria

Incoming Interface

Outgoing Interface

Source 

Destination 

Service Type Service Object Application Group

Application Group 

User 

Traffic Shaping

Download Limit Unlimited Limit Mbps

Upload Limit Unlimited Limit Mbps

Priority

Related Setting

Log

Some changes were made
What do you want to do then?

- 4 The traffic for Teams is now at the highest priority to use the Zyxel Device bandwidth.

CHAPTER 11

ALG

11.1 ALG Overview

Application Layer Gateway (ALG) allows File Transfer Protocol (FTP) to operate properly through the Zyxel Device's NAT.

The ALG feature is only needed for traffic that goes through the Zyxel Device's NAT.

11.1.1 What You Need to Know

Application Layer Gateway (ALG), NAT and Security Policy

The Zyxel Device can function as an Application Layer Gateway (ALG) to allow certain NAT un-friendly applications (such as FTP) to operate properly through the Zyxel Device's NAT and security policy. The Zyxel Device dynamically creates an implicit NAT session and security policy session for the application's traffic from the WAN to the LAN. The ALG on the Zyxel Device supports all of the Zyxel Device's NAT mapping types.

ALG

Some applications cannot operate through NAT (are NAT unfriendly) because they embed IP addresses and port numbers in their packets' data payload. The Zyxel Device examines and uses IP address and port number information embedded in the FTP traffic's data stream. When a device behind the Zyxel Device uses an application for which the Zyxel Device has FTP pass through enabled, the Zyxel Device translates the device's private IP address inside the data stream to a public IP address. It also records session port numbers and allows the related sessions to go through the security policy so the application's traffic can come in from the WAN to the LAN.

ALG and Trunks

If you send your ALG-managed traffic through an interface trunk and all of the interfaces are set to active, you can configure routing policies to specify which interface the ALG-managed traffic uses.

You could also have a trunk with one interface set to active and a second interface set to passive. The Zyxel Device does not automatically change ALG-managed connections to the second (passive) interface when the active interface's connection goes down. When the active interface's connection fails, the client needs to re-initialize the connection through the second interface (that was set to passive) in order to have the connection go through the second interface.

FTP ALG

File Transfer Protocol (FTP) is an Internet file transfer service that operates on the Internet and over TCP/IP networks. A system running the FTP server accepts commands from a system running an FTP client. The service allows users to send commands to the server for uploading and downloading files.

The FTP ALG allows TCP packets with a specified port destination to pass through. If the FTP server is located on the LAN, you must also configure NAT (port forwarding) and security policies if you want to allow access to the server from the WAN.

SIP ALG

- SIP phones can be in any zone (including LAN, DMZ, WAN), and the SIP server and SIP clients can be in the same network or different networks. The SIP server cannot be on the LAN. It must be on the WAN or the DMZ.
- There should be only one SIP server (total) on the Zyxel Device's private networks. Any other SIP servers must be on the WAN. So for example you could have a Back-to-Back User Agent such as the IPPBX x6004 or an asterisk PBX on the DMZ or on the LAN but not on both.
- The SIP ALG handles SIP calls that go through NAT or that the Zyxel Device routes. You can also make other SIP calls that do not go through NAT or routing. Examples would be calls between LAN IP addresses that are on the same subnet.
- The SIP ALG supports peer-to-peer SIP calls. The security policy (by default) allows peer to peer calls from the LAN zone to go to the WAN zone and blocks peer to peer calls from the WAN zone to the LAN zone.
- The SIP ALG allows UDP packets with a specified port destination to pass through.
- The Zyxel Device allows SIP audio connections.
- Configuring the SIP ALG to use custom port numbers for SIP traffic also configures the application patrol (see [Chapter 16 on page 283](#)) to use the same port numbers for SIP traffic. Likewise, configuring the application patrol to use custom port numbers for SIP traffic also configures SIP ALG to use the same port numbers for SIP traffic.

11.1.2 Before You Begin

You must also configure the security policy and enable NAT in the Zyxel Device to allow sessions initiated from the WAN.

11.2 The ALG Screen

Click **Network > ALG** to open the **ALG** screen. Use this screen to:

- Turn ALGs off or on.
- Configure the port numbers to which they apply.

Note: If the Zyxel Device provides an ALG for a service, you must enable the ALG in order to use the application patrol on that service's traffic.

Figure 135 Network > ALG

Network > ALG

FTP ALG

Enable

Enable FTP Transformations

FTP Signaling Port (1-65535)

Additional FTP Signaling Port (1-65535)(Optional)

SIP ALG

Enable

SIP Signaling Port

+ Add - Remove

Port

5060

SIP Inactivity Timeout

Media Inactivity Timeout seconds

Signaling Inactivity Timeout seconds

Restrict Peer to Peer Media Connection i

Restrict Peer to Peer Signaling Connection

The following table describes the labels in this screen.

Table 92 Network > ALG

LABEL	DESCRIPTION
FTP ALG	
Enable	Turn on the FTP ALG to detect FTP (File Transfer Program) traffic and help build FTP sessions through the Zyxel Device's NAT. Enabling the FTP ALG also allows you to use the application patrol to detect FTP traffic.
Enable FTP Transformations	Select this option to have the Zyxel Device modify IP addresses and port numbers embedded in the FTP data payload to match the Zyxel Device's NAT environment. Clear this option if you have an FTP device or server that will modify IP addresses and port numbers embedded in the FTP data payload to match the Zyxel Device's NAT environment.
FTP Signaling Port	If you are using a custom TCP port number (not 21) for FTP traffic, enter it here.
SIP ALG	
Enable	Turn on the SIP ALG to detect SIP traffic and help build SIP sessions through the Zyxel Device's NAT. Enabling the SIP ALG also allows you to use the application patrol to detect SIP traffic and manage the SIP traffic's bandwidth
SIP Signaling Port	If you are using a custom UDP port number (not 5060) for SIP traffic, enter it here. Use the Add icon to add fields if you are also using SIP on additional UDP port numbers.
SIP Inactivity Timeout	Select this option to have the Zyxel Device apply SIP media and signaling inactivity time out limits. These timeouts will take priority over the SIP session time out "Expires" value in a SIP registration response packet.

Table 92 Network > ALG (continued)

LABEL	DESCRIPTION
Media Inactivity Timeout	<p>Use this field to set how many seconds (1-86400) the Zyxel Device will allow a SIP session to remain idle (without voice traffic) before dropping it.</p> <p>If no voice packets go through the SIP ALG before the timeout period expires, the Zyxel Device deletes the audio session. You cannot hear anything and you will need to make a new call to continue your conversation.</p>
Signaling Inactivity Timeout	<p>Most SIP clients have an "expire" mechanism indicating the lifetime of signaling sessions. The SIP user agent sends registration packets to the SIP server periodically and keeps the session alive in the Zyxel Device.</p> <p>If the SIP client does not have this mechanism and makes no calls during the Zyxel Device SIP timeout, the Zyxel Device deletes the signaling session after the timeout period. Enter the SIP signaling session timeout value (1-86400).</p>
Restrict Peer to Peer Media Connection	<p>A media connection is the audio transfer in a SIP connection.</p> <p>Enable this if you want media connections to only arrive from the IP address(es) you registered with. Media connections from other IP addresses will be dropped.</p> <p>You should disable this if have registered for cloud VoIP services.</p>
Restrict Peer to Peer Signaling Connection	<p>A signaling connection is used to set up the SIP connection.</p> <p>Enable this if you want signaling connections to only arrive from the IP address(es) you registered with. Signaling connections from other IP addresses will be dropped.</p>

CHAPTER 12

IPSec VPN

12.1 Virtual Private Networks (VPN) Overview

A virtual private network (VPN) provides secure communications between sites without the expense of leased site-to-site lines. A secure VPN is a combination of tunneling, encryption, authentication, access control and auditing. It is used to transport traffic over the Internet or any insecure network that uses TCP/IP for communication.

IPSec VPN

Internet Protocol Security (IPSec) VPN connects IPSec routers or remote users using IPSec client software. This standards-based VPN offers flexible solutions for secure data communications across a public network. IPSec is built around a number of standardized cryptographic techniques to provide confidentiality, data integrity and authentication at the IP layer. The Zyxel Device can also combine multiple IPSec VPN connections into one secure network. Here local Zyxel Device **X** uses an IPSec VPN tunnel to remote (peer) Zyxel Device **Y** to connect the local (**A**) and remote (**B**) networks.

Figure 136 IPSec VPN Example

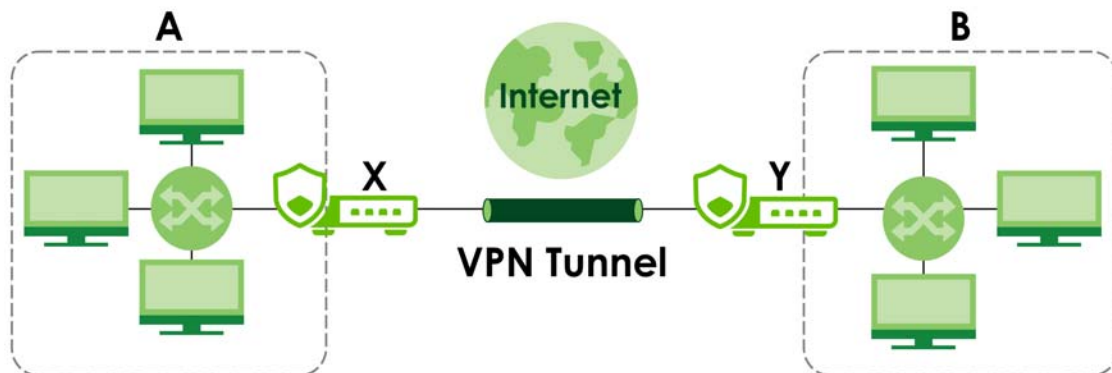

Internet Key Exchange (IKE): IKEv1 and IKEv2

The Zyxel Device supports IKEv1 and IKEv2 for IPv4 traffic. IKE (Internet Key Exchange) is a protocol used in setting up security associations that allows two parties to send data securely.

IKE uses certificates or pre-shared keys for authentication and a Diffie–Hellman key exchange to set up a shared session secret from which encryption keys are derived. A security policy for each peer must be manually created.

IPSec VPN consists of two phases: Phase 1 and Phase 2. Phase 1's purpose is to establish a secure authenticated communication channel by using the Diffie–Hellman key exchange algorithm to generate a shared secret key to encrypt IKE communications. This negotiation results in one single bi-directional ISAKMP Security Association (SA). The authentication can be performed using either pre-

shared key (shared secret), signatures, or public key encryption. Phase 1 operates in either **Main Mode** or **Aggressive Mode**. **Main Mode** protects the identity of the peers, but **Aggressive Mode** does not.

During Phase 2, the remote IPsec routers use the secure channel established in Phase 1 to negotiate Security Associations for IPsec. The negotiation results in a minimum of two unidirectional security associations (one inbound and one outbound). Phase 2 uses Quick Mode (only). Quick mode occurs after IKE has established the secure tunnel in Phase 1. It negotiates a shared IPsec policy, derives shared secret keys used for the IPsec security algorithms, and establishes IPsec SAs. Quick mode is also used to renegotiate a new IPsec SA when the IPsec SA lifetime expires.

Some differences between IKEv1 and IKEv2 include:

- IKEv2 uses less bandwidth than IKEv1. IKEv2 uses one exchange procedure with 4 messages. IKEv1 uses two phases with Main Mode (9 messages) or Aggressive Mode (6 messages) in phase 1.
- IKEv2 supports Extended Authentication Protocol (EAP) authentication, and IKEv1 supports X-Auth. EAP is important when connecting to existing enterprise authentication systems.
- IKEv2 always uses NAT traversal and Dead Peer Detection (DPD), but they can be disabled in IKEv1 using Zyxel Device firmware (the default is on).
- Configuration payload (includes the IP address pool in the VPN setup data) is supported in IKEv2 (off by default), but not in IKEv1.
- Narrowed is supported in IKEv2, but not in IKEv1. Narrowed has the SA apply only to IP addresses in common between the Zyxel Device and the remote IPsec router.
- The IKEv2 protocol supports connectivity checks which is used to detect whether the tunnel is still up or not. If the check fails (the tunnel is down), IKEv2 can re-establish the connection automatically. The Zyxel Device uses firmware to perform connectivity checks when using IKEv1.

12.2 IPsec VPN Background Information

Here is some more detailed IPsec VPN background information.

12.2.1 IKE SA Overview

The IKE SA provides a secure connection between the Zyxel Device and remote IPsec router.

It takes several steps to establish an IKE SA. The negotiation mode determines how many. There are two negotiation modes for IKEv1--main mode and aggressive mode. Main mode provides better security, while aggressive mode is faster.

Note: Both routers must use the same negotiation mode.

These modes are discussed in more detail in [Negotiation Mode](#). Main mode is used in various examples in the rest of this section.

The Zyxel Device supports IKEv1 and IKEv2. See [Section 12.1 on page 187](#) for more information.

IP Addresses of the Zyxel Device and Remote IPsec Router

To set up an IKE SA, you have to specify the IP addresses of the Zyxel Device and remote IPsec router. You can usually enter a static IP address or a domain name for either or both IP addresses. Sometimes,

your Zyxel Device might offer another alternative, such as using the IP address of a port or interface, as well.

You can also specify the IP address of the remote IPsec router as 0.0.0.0. This means that the remote IPsec router can have any IP address. In this case, only the remote IPsec router can initiate an IKE SA because the Zyxel Device does not know the IP address of the remote IPsec router. This is often used for telecommuters.

IKE SA Proposal

The IKE SA proposal is used to identify the encryption algorithm, authentication algorithm, and Diffie-Hellman (DH) key group that the Zyxel Device and remote IPsec router use in the IKE SA. In main mode, this is done in steps 1 and 2, as illustrated next.

Figure 137 IKE SA: Main Negotiation Mode, Steps 1 - 2: IKE SA Proposal

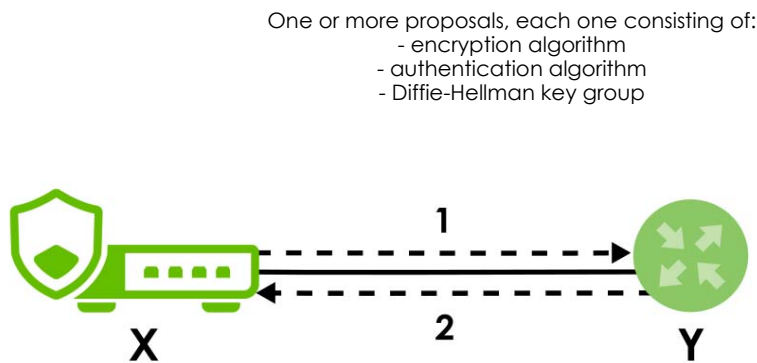

The Zyxel Device sends one or more proposals to the remote IPsec router. (In some devices, you can only set up one proposal.) Each proposal consists of an encryption algorithm, authentication algorithm, and DH key group that the Zyxel Device wants to use in the IKE SA. The remote IPsec router selects an acceptable proposal and sends the accepted proposal back to the Zyxel Device. If the remote IPsec router rejects all of the proposals, the Zyxel Device and remote IPsec router cannot establish an IKE SA.

Note: Both routers must use the same encryption algorithm, authentication algorithm, and DH key group.

In most Zyxel Devices, you can select one of the following encryption algorithms for each proposal. The algorithms are listed in order from weakest to strongest.

- Data Encryption Standard (DES) is a widely used method of data encryption. It applies a 56-bit key to each 64-bit block of data.
- Triple DES (3DES) is a variant of DES. It iterates three times with three separate keys, effectively tripling the strength of DES.
- Advanced Encryption Standard (AES) is a newer method of data encryption that also uses a secret key. AES applies a 128-bit key to 128-bit blocks of data. It is faster than 3DES.

Some Zyxel Devices also offer stronger forms of AES that apply 192-bit or 256-bit keys to 128-bit blocks of data.

In most Zyxel Devices, you can select one of the following authentication algorithms for each proposal. The algorithms are listed in order from weakest to strongest.

- MD5 (Message Digest 5) produces a 128-bit digest to authenticate packet data.
- SHA1 (Secure Hash Algorithm) produces a 160-bit digest to authenticate packet data.
- SHA256 (Secure Hash Algorithm) produces a 256-bit digest to authenticate packet data.
- SHA512 (Secure Hash Algorithm) produces a 512-bit digest to authenticate packet data.

See [Diffie-Hellman \(DH\) Key Exchange on page 190](#) for more information about DH key groups.

Diffie-Hellman (DH) Key Exchange

The Zyxel Device and the remote IPsec router use DH public-key cryptography to establish a shared secret. The shared secret is then used to generate encryption keys for the IKE SA and IPsec SA. In main mode, this is done in steps 3 and 4, as illustrated next.

Figure 138 IKE SA: Main Negotiation Mode, Steps 3 - 4: DH Key Exchange

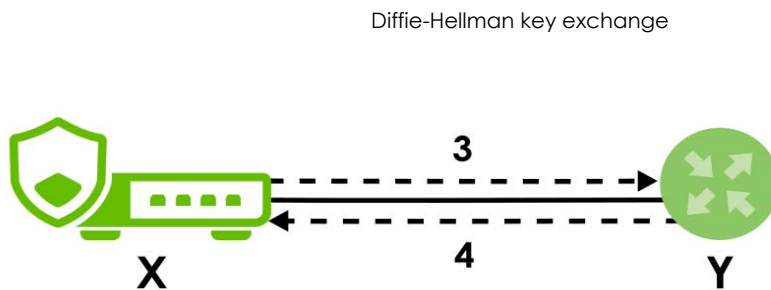

DH public-key cryptography is based on DH key groups. Each key group is a fixed number of bits long. The longer the key, the more secure the encryption, but also the longer it takes to encrypt and decrypt information. For example, DH2 keys (1024 bits) are more secure than DH1 keys (768 bits), but DH2 keys take longer to encrypt and decrypt.

Authentication

Before the Zyxel Device and remote IPsec router establish an IKE SA, they have to verify each other's identity. This process is based on pre-shared keys and router identities.

In main mode, the Zyxel Device and remote IPsec router authenticate each other in steps 5 and 6, as illustrated below. The identities are also encrypted using the encryption algorithm and encryption key the Zyxel Device and remote IPsec router selected in previous steps.

Figure 139 IKE SA: Main Negotiation Mode, Steps 5 - 6: Authentication (continued)

Step 5:
pre-shared key
Zyxel Device identity, consisting of
- ID type
Step 6:
pre-shared key
Remote IPsec router identity, consisting of
- ID type

You have to create (and distribute) a pre-shared key. The Zyxel Device and remote IPsec router use it in the authentication process, though it is not actually transmitted or exchanged.

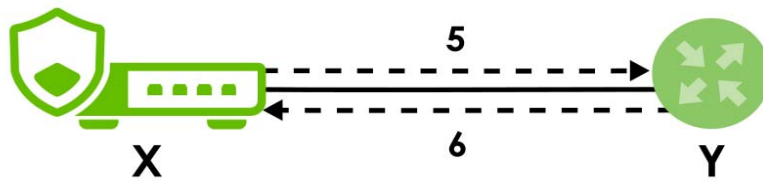

Note: The Zyxel Device and the remote IPsec router must use the same pre-shared key.

Router identity consists of ID type. The ID type can be domain name, IP address, or email address. The content is only used for identification. Any domain name or email address that you enter does not have to actually exist. Similarly, any domain name or IP address that you enter does not have to correspond to the Zyxel Device's or remote IPsec router's properties.

The Zyxel Device and the remote IPsec router have their own identities, so both of them must store two sets of information, one for themselves and one for the other router. Local ID type refers to the content that applies to the router itself, and remote ID type refers to the content that applies to the other router.

Note: The Zyxel Device's local and remote ID content must match the remote IPsec router's remote and local ID content, respectively.

For example, in the next table, the Zyxel Device and the remote IPsec router authenticate each other successfully. In contrast, in the following table, the Zyxel Device and the remote IPsec router cannot authenticate each other and, therefore, cannot establish an IKE SA.

Table 93 VPN Example: Matching ID Type and Content

ZYXEL DEVICE	REMOTE IPSEC ROUTER
Local ID type: tom@youroffice.com	Local ID type: 1.1.1.2
Peer ID type: 1.1.1.2	Peer ID type: tom@youroffice.com

Table 94 VPN Example: Mismatching ID Type and Content

ZYXEL DEVICE	REMOTE IPSEC ROUTER
Local ID type: tom@youroffice.com	Local ID type: 1.1.1.2
Peer ID type: 1.1.1.20	Peer ID type: tom@youroffice.com

It is also possible to configure the Zyxel Device to ignore the identity of the remote IPsec router. In this case, you usually leave the remote ID type field empty. This is less secure, so you should only use this if your Zyxel Device provides another way to check the identity of the remote IPsec router (for example, extended authentication) or if you are troubleshooting a VPN tunnel.

12.2.2 Additional Topics for IKE SA

This section provides more information about IKE SA.

Negotiation Mode

There are two negotiation modes for IKEv1—main mode and aggressive mode. Main mode provides better security, while aggressive mode is faster.

Main mode takes six steps to establish an IKE SA.

Steps 1 - 2: The Zyxel Device sends its proposals to the remote IPsec router. The remote IPsec router selects an acceptable proposal and sends it back to the Zyxel Device.

Steps 3 - 4: The Zyxel Device and the remote IPsec router exchange pre-shared keys for authentication and participate in a Diffie-Hellman key exchange, based on the accepted DH key group, to establish a shared secret.

Steps 5 - 6: Finally, the Zyxel Device and the remote IPsec router generate an encryption key (from the shared secret), encrypt their identities, and exchange their encrypted identity information for authentication.

In contrast, aggressive mode only takes three steps to establish an IKE SA. Aggressive mode does not provide as much security because the identity of the Zyxel Device and the identity of the remote IPsec router are not encrypted. It is usually used in remote-access situations, where the address of the initiator is not known by the responder and both parties want to use pre-shared keys for authentication. For example, the remote IPsec router may be a telecommuter who does not have a static IP address.

VPN, NAT, and NAT Traversal

In the following example, there is another router (**A**) between router **X** and router **Y**.

Figure 140 VPN/NAT Example

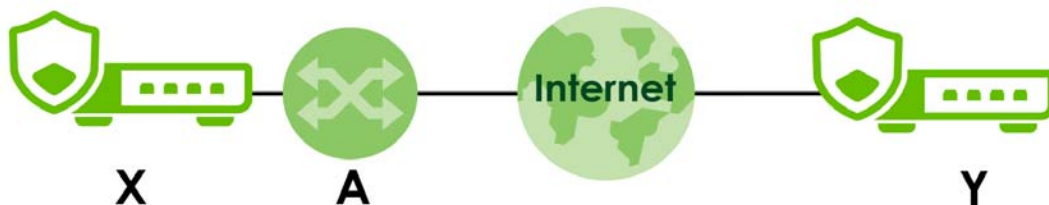

If router **A** does NAT, it might change the IP addresses, port numbers, or both. If router **X** and router **Y** try to establish a VPN tunnel, the authentication fails because it depends on this information. The routers cannot establish a VPN tunnel.

Most routers like router **A** now have an IPsec pass-thru feature. This feature helps router **A** recognize VPN packets and route them appropriately. If router **A** has this feature, router **X** and router **Y** can establish a VPN tunnel as long as the active protocol is ESP. (See [Active Protocol on page 193](#) for more information about active protocols.)

If router **A** does not have an IPsec pass-thru or if the active protocol is AH, you can solve this problem by enabling NAT traversal. In NAT traversal, router **X** and router **Y** add an extra header to the IKE SA and IPsec SA packets. If you configure router **A** to forward these packets unchanged, router **X** and router **Y** can establish a VPN tunnel.

You have to do the following things to set up NAT traversal.

- Enable NAT traversal on the Zyxel Device and remote IPsec router.
- Configure the NAT router to forward packets with the extra header unchanged. (See the field description for detailed information about the extra header.)

The extra header may be UDP port 500 or UDP port 4500, depending on the standard(s) the Zyxel Device and remote IPsec router support.

Certificates

It is possible for the Zyxel Device and remote IPSec router to authenticate each other with certificates. In this case, you do not have to set up the pre-shared key, local identity, or remote identity because the certificates provide this information instead.

- Instead of using the pre-shared key, the Zyxel Device and remote IPSec router check the signatures on each other's certificates. Unlike pre-shared keys, the signatures do not have to match.
- The local and peer ID type and content come from the certificates.

Note: You must set up the certificates for the Zyxel Device and remote IPSec router first.

IPSec SA Overview

Once the Zyxel Device and remote IPSec router have established the IKE SA, they can securely negotiate an IPSec SA through which to send data between computers on the networks.

Note: The IPSec SA stays connected even if the underlying IKE SA is not available anymore.

This section introduces the key components of an IPSec SA.

Local Network and Remote Network

In an IPSec SA, the local network, the one(s) connected to the Zyxel Device, may be called the local policy. Similarly, the remote network, the one(s) connected to the remote IPSec router, may be called the remote policy.

Active Protocol

The active protocol controls the format of each packet. It also specifies how much of each packet is protected by the encryption and authentication algorithms. IPSec VPN includes two active protocols, AH (Authentication Header, RFC 2402) and ESP (Encapsulating Security Payload, RFC 2406).

Note: The Zyxel Device and remote IPSec router must use the same active protocol.

Usually, you should select ESP. AH does not support encryption, and ESP is more suitable with NAT.

Encapsulation

There are two ways to encapsulate packets. Usually, you should use tunnel mode because it is more secure. Transport mode is only used when the IPSec SA is used for communication between the Zyxel Device and remote IPSec router (for example, for remote management), not between computers on the local and remote networks.

Note: The Zyxel Device and remote IPSec router must use the same encapsulation.

These modes are illustrated below.

Figure 141 VPN: Transport and Tunnel Mode Encapsulation

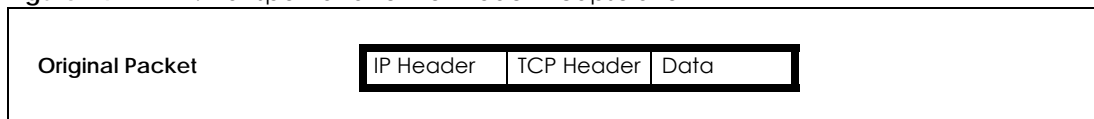
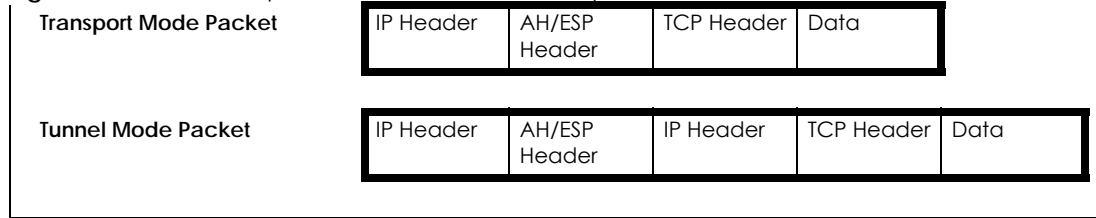

Figure 141 VPN: Transport and Tunnel Mode Encapsulation

In tunnel mode, the Zyxel Device uses the active protocol to encapsulate the entire IP packet. As a result, there are two IP headers:

- **Outside header:** The outside IP header contains the IP address of the Zyxel Device or remote IPsec router, whichever is the destination.
- **Inside header:** The inside IP header contains the IP address of the computer behind the Zyxel Device or remote IPsec router. The header for the active protocol (AH or ESP) appears between the IP headers.

In transport mode, the encapsulation depends on the active protocol. With AH, the Zyxel Device includes part of the original IP header when it encapsulates the packet. With ESP, however, the Zyxel Device does not include the IP header when it encapsulates the packet, so it is not possible to verify the integrity of the source IP address.

IPsec SA Proposal and Perfect Forward Secrecy

An IPsec SA proposal is similar to an IKE SA proposal (see [IKE SA Proposal](#)), except that you also have the choice whether or not the Zyxel Device and remote IPsec router perform a new DH key exchange every time an IPsec SA is established. This is called Perfect Forward Secrecy (PFS).

If you enable PFS, the Zyxel Device and remote IPsec router perform a DH key exchange every time an IPsec SA is established, changing the root key from which encryption keys are generated. As a result, if one encryption key is compromised, other encryption keys remain secure.

If you do not enable PFS, the Zyxel Device and remote IPsec router use the same root key that was generated when the IKE SA was established to generate encryption keys.

The DH key exchange is time-consuming and may be unnecessary for data that does not require such security.

PFS is ignored in initial IKEv2 authentication but is used when re-authenticating.

12.2.3 Additional Topics for IPsec SA

This section provides more information about IPsec SA in your Zyxel Device.

Authentication and the Security Parameter Index (SPI)

For authentication, the Zyxel Device and remote IPsec router use the SPI, instead of pre-shared keys, ID type and content. The SPI is an identification number.

Note: The Zyxel Device and remote IPsec router must use the same SPI.

12.2.4 What You Can Do in this Chapter

- Use the **Site to Site VPN** screen (see [Section 12.3 on page 196](#)) to view a summary of the VPN rules.
- Use the **Site to Site VPN Add/Edit** screens (see [Section 12.3.2 on page 202](#) and [Section 12.3.2 on page 202](#)) to create a VPN rule using the wizard or create a customized VPN rule with advanced settings.
- Use the **Remote Access VPN** screen (see [Section 12.4 on page 209](#)) to create a remote access VPN rule.

12.2.5 What You Need to Know

An IPsec VPN tunnel is usually established in two phases. Each phase establishes a security association (SA), a contract indicating what security parameters the Zyxel Device and the remote IPsec router will use. The first phase establishes an Internet Key Exchange (IKE) SA between the Zyxel Device and remote IPsec router. The second phase uses the IKE SA to securely establish an IPsec SA through which the Zyxel Device and remote IPsec router can send data between computers on the local network and remote network. This is illustrated in the following figure.

Figure 142 VPN: IKE SA and IPsec SA

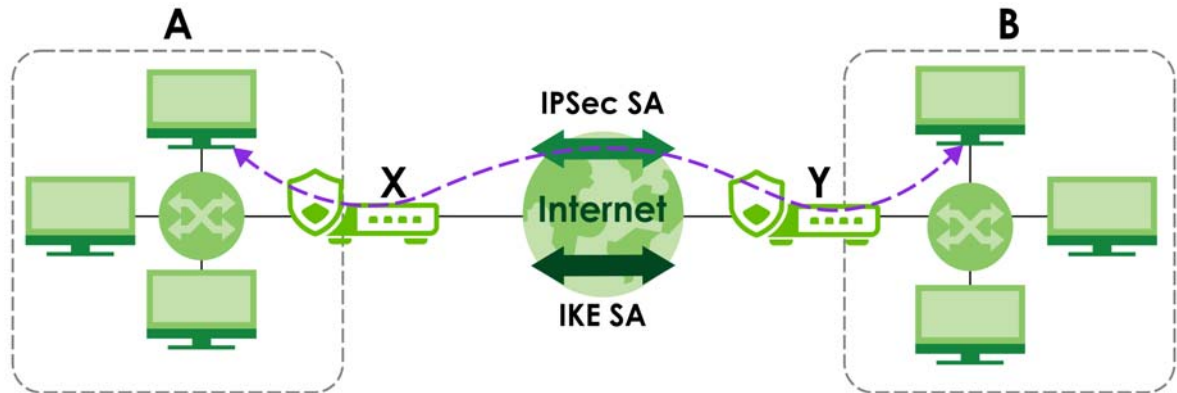

In this example, a computer in network **A** is exchanging data with a computer in network **B**. Inside networks **A** and **B**, the data is transmitted the same way data is normally transmitted in the networks. Between routers **X** and **Y**, the data is protected by tunneling, encryption, authentication, and other security features of the IPsec SA. The IPsec SA is secure because routers **X** and **Y** established the IKE SA first.

Application Scenarios

The Zyxel Device's application scenarios make it easier to configure your VPN connection settings.

Table 95 IPsec VPN Application Scenarios

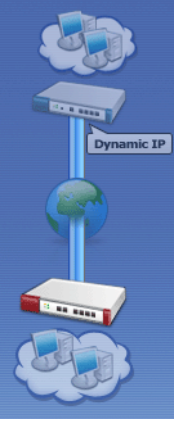
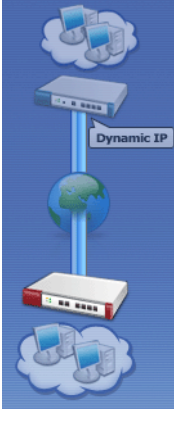
SITE-TO-SITE	SITE-TO-SITE WITH DYNAMIC PEER
	
<p>Choose this if the remote IPsec router has a static IP address or a domain name.</p> <p>This Zyxel Device can initiate the VPN tunnel.</p> <p>The remote IPsec router can also initiate the VPN tunnel if this Zyxel Device has a static IP address or a domain name.</p>	<p>Choose this if the remote IPsec router has a dynamic IP address.</p> <p>You don't specify the remote IPsec router's address, but you specify the remote policy (the addresses of the devices behind the remote IPsec router).</p> <p>This Zyxel Device must have a static IP address or a domain name.</p> <p>Only the remote IPsec router can initiate the VPN tunnel.</p>

12.3 The Site to Site VPN Screen

Click **VPN > Site to Site VPN** to open the **Site to Site VPN** screen. The **Site to Site VPN** screen lists the VPN connection associated VPN gateway(s), and various settings. In addition, it also lets you activate or deactivate and connect or disconnect each VPN connection (each IPsec SA). Click a column's heading cell to sort the table entries by that column's criteria. Click the heading cell again to reverse the sort order.

Figure 143 VPN > IPsec VPN > Site to Site VPN

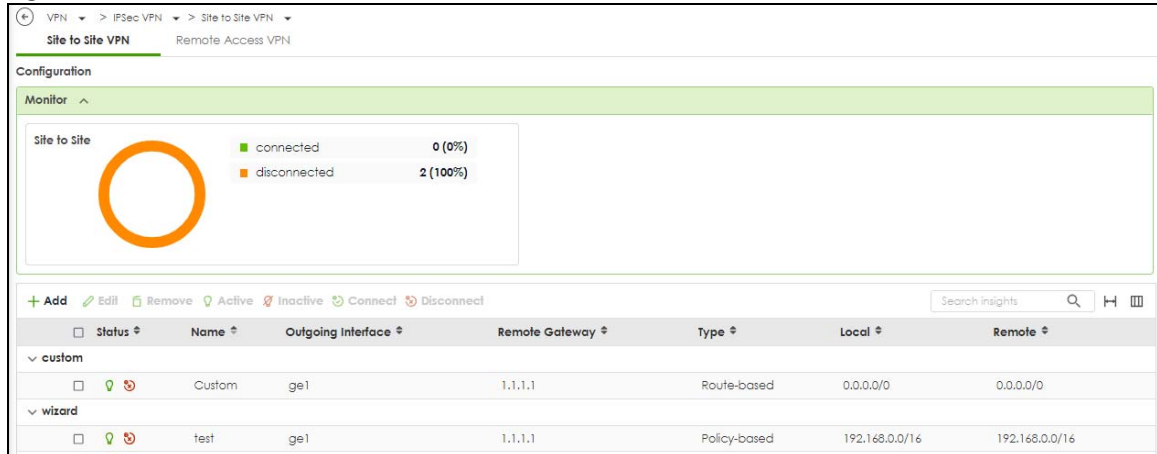

Each field is discussed in the following table.

Table 96 VPN > IPsec VPN > Site to Site VPN

LABEL	DESCRIPTION
Monitor	The graph shows the number of connected and disconnected VPNs.
Add	Click this to create a new entry.
Edit	Double-click an entry or select it and click Edit to open a screen where you can modify the entry's settings.
Remove	To remove an entry, select it and click Remove . The Zyxel Device confirms you want to remove it before doing so.
Active	To turn on an entry, select it and click Activate .
Inactive	To turn off an entry, select it and click Inactivate .
Connect	To connect an IPsec SA, select it and click Connect .
Disconnect	To disconnect an IPsec SA, select it and click Disconnect .
Status	The activate (light bulb) icon is lit when the entry is active and dimmed when the entry is inactive. The connect icon is lit when the interface is connected and dimmed when it is disconnected.
Name	This field displays the name of the VPN rule.
Outgoing Interface	This field displays the interface IP address or DNS name the VPN connection uses to transmit packets.
Remote Gateway	This field displays the remote IPsec device IP address or DNS name in use for this VPN connection.
Type	This field displays the type (route based or policy based) the VPN rule is using.
Type	This field displays if the VPN rule is configured through wizard or a customized rule.
Local	This field displays the IP address of the computer on your network.
Remote	This field displays the IP address of the computer behind the remote IPsec device.

12.3.1 The Site to Site VPN Add/Edit Screen- Wizard

The **Site to Site VPN Add/Edit Gateway** screen allows you to create a new VPN connection policy or edit an existing one. To access this screen, go to the **VPN > Site to Site VPN** screen, and click either the **Add** icon or an **Edit** icon. Select **Site-to-Site** in **VPN > Site to Site VPN > Add/Edit > Scenario > Type** to create a VPN rule using the wizard.

12.3.1.1 Scenario

Use this screen to configure the VPN connection name and select the scenario that best describes your intended VPN connection.

Figure 144 VPN > Site to Site VPN > Add/Edit > Scenario

The screenshot displays the 'Scenario' configuration step of a VPN wizard. It includes a progress indicator at the top, a form with several fields and radio buttons, and a diagram at the bottom. The 'Name' field is currently empty and has a red error message. The 'Type' is set to 'Site-to-Site'. The 'Behind NAT' option is set to 'None'. The diagram shows two sites connected through the Internet.

Each field is described in the following table.

Table 97 VPN > Site-to-Site VPN > Add/Edit > Scenario

LABEL	DESCRIPTION
Name	Type the name used to identify this rule. You may use 1-31 single-byte characters, including 0-9a-zA-Z, underscores (_), or dashes (-), but the first character cannot be a number. This value is case-sensitive.
IKE Version	Select IKEv1 or IKEv2. IKEv1 applies to IPv4 traffic only. IKEv2 applies to both IPv4 and IPv6 traffic. IKE (Internet Key Exchange) is a protocol used in setting up security associations that allows two parties to send data securely. See Section 12.1 on page 187 for more information on IKEv1 and IKEv2.
Type	Select Site-to-Site to configure the VPN rule using the wizard. Select Custom to configure the VPN rule with customized settings.
Behind NAT	None/ Local Site: The remote IPsec device has a static IP address or a domain name. This Zyxel Device can initiate the VPN tunnel. Remote Site: The remote IPsec device has a dynamic IP address. Only the remote IPsec device can initiate the VPN tunnel.

12.3.1.2 Network

Use this screen to configure the Zyxel Device interface and remote IPsec device settings.

Figure 145 VPN > Site to Site VPN > Add/Edit > Network

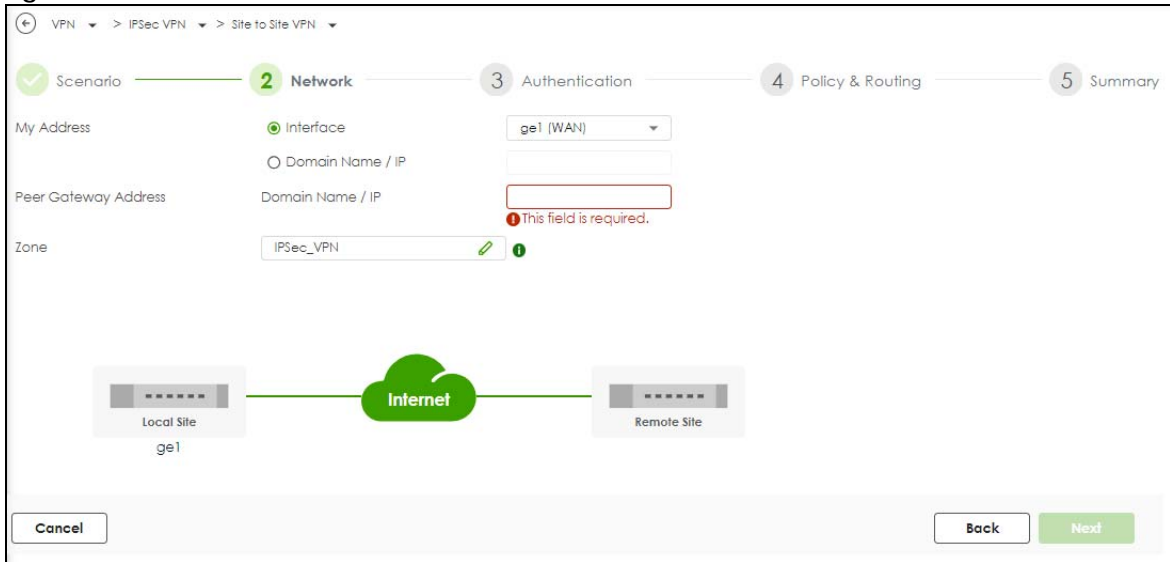

Each field is described in the following table.

Table 98 VPN > Site-to-Site VPN > Add/Edit > Network

LABEL	DESCRIPTION
My Address	Select an interface or enter the IPv4 address or domain name of the interface the VPN connection uses to transmit packets out of the Zyxel Device.
Peer Gateway Address	Enter the WAN IPv4 address or domain name of the remote IPsec device to identify the remote IPsec router by its IP address or domain name.
Zone	Select a zone for the IPsec policy. <div data-bbox="548 1213 1062 1633" style="border: 1px solid black; padding: 5px; margin: 5px 0;"> <p>Select Zone [X]</p> <p>Search [] [Q]</p> <p style="text-align: right;">+ Add Object</p> <p><input type="radio"/> none</p> <p>Object (5) [^]</p> <p><input type="radio"/> WAN</p> <p><input type="radio"/> LAN</p> <p><input type="radio"/> DMZ</p> <p><input checked="" type="radio"/> IPsec_VPN</p> <p><input type="radio"/> SSL_VPN</p> </div> <p>Go to Security Policy > Policy Control to make sure that a security policy will not block traffic going to the zone you select.</p>

12.3.1.3 Authentication

Use this screen to configure the authentication type and settings.

Figure 146 VPN > Site to Site VPN > Add/Edit > Authentication

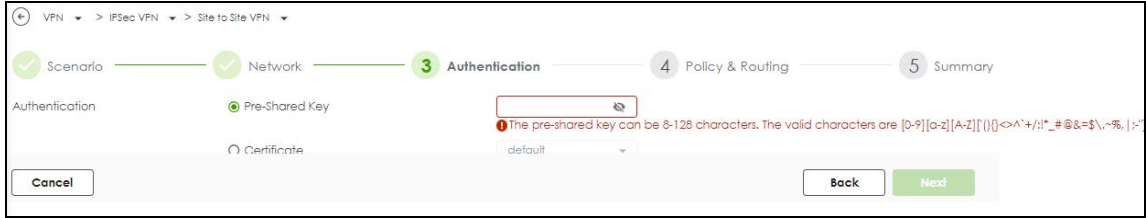

Each field is described in the following table.

Table 99 VPN > Site-to-Site VPN > Add/Edit > Authentication

LABEL	DESCRIPTION
Pre-Shared Key	<p>Select this to have the Zyxel Device and remote IPsec router use a pre-shared key (password) of up to 128 characters to identify each other when they negotiate the IKE SA. Type the pre-shared key in the field to the right. The pre-shared key can be:</p> <ul style="list-style-type: none"> 8 to 128 single-byte characters, including [0-9][a-z][A-Z][(){}<>^`+/:!*_#@&=\$\~%.\ -;~"] <p>The Zyxel Device and remote IPsec router must use the same pre-shared key.</p> <p>Click the eye icon to see the pre-shared key in readable plain text.</p>
Certificate	Alternatively, select Certificate to use one of the Zyxel Device certificates for authentication.

12.3.1.4 Policy & Routing

Use this screen to configure the IP addresses of the computer on your network and the computer behind the remote IPsec device.

Figure 147 VPN > Site to Site VPN > Add/Edit > Policy & Routing (Route-Based)

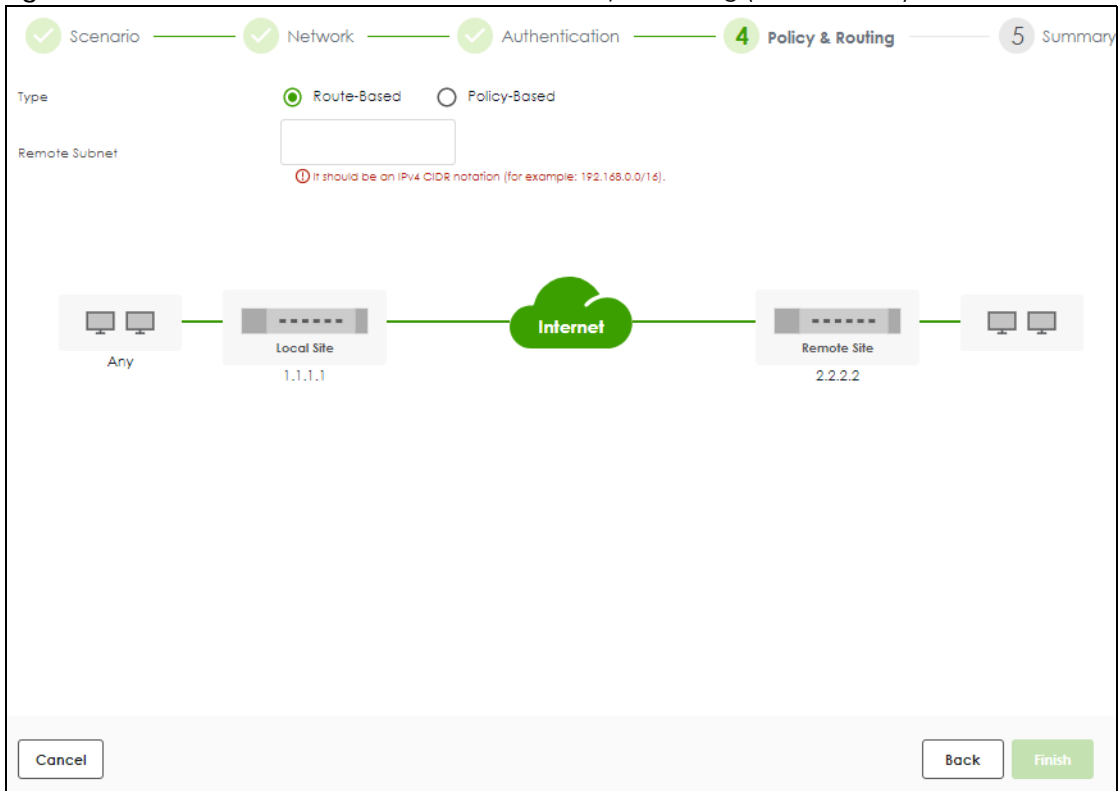

Figure 148 VPN > Site to Site VPN > Add/Edit > Policy & Routing (Policy-Based)

Scenario Network Authentication **4 Policy & Routing** 5 Summary

Type Route-Based Policy-Based

Local Subnet
ⓘ It should be an IPv4 or IPv4 CIDR notation (for example: 192.168.0.0/16 or 192.168.0.0).

Remote Subnet
ⓘ It should be an IPv4 or IPv4 CIDR notation (for example: 192.168.0.0/16 or 192.168.0.0).

Local Site: 1.1.1.1

Remote Site: 2.2.2.2

Internet

Cancel Back Finish

Each field is described in the following table.

Table 100 VPN > Site-to-Site VPN > Add/Edit > Policy & Routing

LABEL	DESCRIPTION
Type	Select Route-Based to create a VPN rule that encrypts traffic based on the static route settings. Select Policy-Based to create a VPN rule that encrypts traffic based on the IPv4 addresses you set in Local Subnet and Remote Subnet .
Local Subnet	Type the IP address of a computer on your network that can use the tunnel. You can also specify a subnet. This must match the remote IP address configured on the remote IPsec device.
Remote Subnet	Type the IP address of a computer behind the remote IPsec device. You can also specify a subnet. This must match the local IP address configured on the remote IPsec device.

12.3.1.5 Summary

Use this screen to view a summary of the VPN tunnel configurations. You can click **Edit** to change the VPN tunnel configuration settings.

Figure 149 VPN > Site to Site VPN > Add/Edit > Summary

Configuration	
Name	test
IKE Version	2
Scenario	wizard
Type	Policy

Network	
Local Site	1.1.1.1
Remote Site	1.1.1.1

Authentication	
Authentication	pre-shared-key

Policy & Routing	
Local Subnet	2.2.2.2
Remote Subnet	3.3.3.3

12.3.2 The Site to Site VPN Add/Edit Screen - Custom

The **Site to Site VPN Add/Edit Gateway** screen allows you to create a new VPN connection policy or edit an existing one. To access this screen, go to the **VPN > Site to Site VPN** screen, and click either the **Add** icon or an **Edit** icon. Select **Custom** in **VPN > Site to Site VPN > Add/Edit > Scenario > Type** to create a customized VPN rule with advanced settings.

See [Section 12.1 on page 187](#) for more information on phase 1 and phase 2 settings; see [Section 12.2 on page 188](#) for more information on IKE SA proposals.

Figure 150 VPN > Site to Site VPN > Add/Edit > Scenario > Type > Custom

Each field is described in the following table.

Table 101 VPN > Site-to-Site VPN > Add/Edit > Scenario > Type > Custom

LABEL	DESCRIPTION
General Settings	
Enable	Slide the switch to the right to activate this VPN connection
Name	Type the name used to identify this rule. You may use 1-31 single-byte characters, including 0-9a-zA-Z, underscores (_), or dashes (-), but the first character cannot be a number. This value is case-sensitive.
IKE Version	Select IKEv1 or IKEv2. IKEv1 applies to IPv4 traffic only. IKEv2 applies to both IPv4 and IPv6 traffic. IKE (Internet Key Exchange) is a protocol used in setting up security associations that allows two parties to send data securely. See Section 12.1 on page 187 for more information on IKEv1 and IKEv2.
Type	Select Route-Based to create a VPN rule that encrypts traffic based on the static route settings. Select Policy-Based to create a VPN rule that encrypts traffic based on the Local and Remote IPv4 addresses you set in Policy in Phase 2 Settings .
Network	
My Address	Type the IP address of a computer on your network that can use the tunnel. You can also specify a subnet. This must match the remote IP address configured on the remote IPsec device.

Table 101 VPN > Site-to-Site VPN > Add/Edit > Scenario > Type > Custom (continued)

LABEL	DESCRIPTION
Peer Gateway Address	<p>Select Domain Name/IP to enter the domain name or the IP address of the remote IPsec router.</p> <p>Select Dynamic Address if the remote IPsec router has a dynamic IP address (and does not use DDNS).</p>
Zone	<p>Select a zone for the IPsec policy.</p>  <p>Go to Security Policy > Policy Control to make sure that a security policy will not block traffic going to the zone you select.</p>
Authentication	
Pre-Shared Key	<p>Select this to have the Zyxel Device and remote IPsec router use a pre-shared key (password) of up to 128 characters to identify each other when they negotiate the IKE SA. Type the pre-shared key in the field to the right. The pre-shared key can be:</p> <ul style="list-style-type: none"> 8 to 128 single-byte characters, including [0-9][a-z][A-Z][{}<>^`+/:!*_#@&=\$\.%~% ;:-"] <p>The Zyxel Device and remote IPsec router must use the same pre-shared key.</p> <p>Click the eye to see the pre-shared key in readable plain text.</p>
Certificate	<p>Alternatively, select Certificate to use one of the Zyxel Device certificates for authentication.</p>
Advanced Settings	
Local ID	<p>Enter one of the followings to identify the Zyxel Device during authentication.</p> <p>IPv4 - the Zyxel Device is identified by an IP address</p> <p>DNS - the Zyxel Device is identified by a domain name</p> <p>E-mail - the Zyxel Device is identified by the string specified in this field</p>
Remote ID	<p>Enter one of the followings to identify the remote IPsec router during authentication.</p> <p>IPv4 - the remote IPsec router is identified by an IP address</p> <p>DNS - the remote IPsec router is identified by a domain name</p> <p>E-mail - the remote IPsec router is identified by the string specified in this field</p> <p>If the Zyxel Device and remote IPsec router use certificates, there is one more choice.</p> <p>Subject Name - the remote IPsec router is identified by the subject name in the certificate</p>
Phase 1 Settings	<p>This establishes a secure tunnel between the Zyxel Device and the peer site.</p>

Table 101 VPN > Site-to-Site VPN > Add/Edit > Scenario > Type > Custom (continued)

LABEL	DESCRIPTION
SA Life Time	<p>Set how often the Zyxel Device renegotiates the IKE SA. A short SA life time increases security, but renegotiation temporarily disconnects the VPN tunnel.</p> <p>The value you set for the SA life time in Phase 1 Settings should be greater than or equal to the value you set for the SA life time in Phase 2 Settings.</p>
Add	Click this to add an entry.
Edit	Select an entry and click this to edit the entry.
Remove	Select an entry and click this to remove the entry.
Proposal	
Encryption	<p>Select which key size and encryption algorithm to use in the IPsec SA. Choices are:</p> <p>des-cbc - a 56-bit key with the DES encryption algorithm</p> <p>3des-cbc - a 168-bit key with the DES encryption algorithm</p> <p>aes128-cbc - a 128-bit key with the AES encryption algorithm</p> <p>aes192-cbc - a 192-bit key with the AES encryption algorithm</p> <p>aes256-cbc - a 256-bit key with the AES encryption algorithm</p> <p>The Zyxel Device and the remote IPsec router must both have at least one proposal that uses the same encryption and the same key.</p> <p>Longer keys are more secure, but require more processing power, resulting in increased latency and decreased throughput.</p>
Authentication	<p>Select which hash algorithm to use to authenticate packet data in the IPsec SA. Choices are hmac-md5, hmac-sha1, hmac-sha256, hmac-sha384 and hmac-sha512. SHA is generally considered stronger than MD5, but it is also slower.</p> <p>The Zyxel Device and the remote IPsec router must both have a proposal that uses the same authentication algorithm.</p>
Diffie-Hellman Groups	<p>Select which Diffie-Hellman key group (DHx) you want to use to create encryption keys. Choices are DH2, DH5, DH14, DH15, DH16, DH19, DH20, DH21, DH28, DH29, and DH30.</p> <p>The longer the key, the more secure the encryption, but also the longer it takes to encrypt and decrypt information. The Zyxel Device and the remote IPsec router must use the same DH key group. See Section 12.2 on page 188 for more information on DH key group.</p> <p>Different operating systems may support different DH key groups. Check your operating system documentation.</p> <ul style="list-style-type: none"> For Windows VPN clients, Zyxel SecuExtender perpetual VPN clients versions 3.8.203.61.32 and earlier support DH1 to DH14. For macOS VPN clients, Zyxel SecuExtender subscription VPN clients versions 1.2.0.7 and later support DH14 to DH21. For Windows VPN clients, Zyxel SecuExtender subscription VPN clients versions 5.6.80.007 and later support DH14 to DH21. Windows versions 7, 10, 11 built-in IKEv2 VPN clients support DH2 by default. macOS versions 14.2 and later built-in IKEv2 VPN clients support DH14 by default. iOS versions 10.15 and later built-in IKEv2 VPN clients support DH14 by default.
Advanced Settings	
DPD Delay	<p>Configure this field if you want the Zyxel Device to make sure the remote IPsec router is there before it transmits data through the IKE SA. The remote IPsec router must support Dead Peer Detection (DPD).</p> <p>Set how many seconds the Zyxel Device will wait before sending a message to the remote IPsec router if there has been no traffic. If the remote IPsec router responds, the Zyxel Device transmits the data. If the remote IPsec router does not respond, the Zyxel Device shuts down the IKE SA.</p> <p>This field applies for IKEv1 only. DPD is always performed when you use IKEv2.</p>

Table 101 VPN > Site-to-Site VPN > Add/Edit > Scenario > Type > Custom (continued)

LABEL	DESCRIPTION
UDP Encapsulation	Enable to encrypt a UDP connection.
Phase 2 Settings	This secures the actual data transmission between the Zyxel Device and the peer site, based on the secure key settings established in Phase 1.
Initiation	Select how Phase 2 of the IPsec connection is established on the Zyxel Device. Auto: Select this to have the Zyxel Device listen for incoming traffic and automatically establish the Phase 2 of the IPsec connection when traffic is detected. Nailed-Up: Select this to have the Zyxel Device initiate Phase 2 of the IPsec connection. The Zyxel Device automatically renegotiates the IPsec SA when the SA lifetime expires, ensuring the continuity of the connection. Responder Only: Select this to have the Zyxel Device wait for the peer site to initiate the Phase 2 of the IPsec connection.
Policy	
Add	Click this to add an entry.
Edit	Select an entry and click this to edit the entry.
Remove	Select an entry and click this to remove the entry.
Local	Enter the address corresponding to the local network.
Remote	Enter the address corresponding to the remote network.
Protocol	Select the protocol required to use this translation. Choices are: TCP, UDP, ICMP, GRE or Any .
Active Protocol	Select which protocol you want to use in the IPsec SA. ESP (RFC 2406) - provides encryption and the same services offered by AH , but its authentication is weaker. The Zyxel Device and remote IPsec router must use the same active protocol.
Encapsulation	Select which type of encapsulation the IPsec SA uses. Tunnel - this mode encrypts the IP header information and the data. The Zyxel Device and remote IPsec router must use the same encapsulation.
SA Life Time	Set how often the Zyxel Device renegotiates the IKE SA. A short SA life time increases security, but renegotiation temporarily disconnects the VPN tunnel. The value you set for the SA life time in Phase 2 Settings should be lesser than or equal to the value you set for the SA life time in Phase 1 Settings .
Add	Click this to add an entry.
Edit	Select an entry and click this to edit the entry.
Remove	Select an entry and click this to remove the entry.
Encryption	Select which key size and encryption algorithm to use in the IPsec SA. Choices are: des-cbc - a 56-bit key with the DES encryption algorithm 3des-cbc - a 168-bit key with the DES encryption algorithm aes128-cbc - a 128-bit key with the AES encryption algorithm aes192-cbc - a 192-bit key with the AES encryption algorithm aes256-cbc - a 256-bit key with the AES encryption algorithm The Zyxel Device and the remote IPsec router must both have at least one proposal that uses use the same encryption and the same key. Longer keys are more secure, but require more processing power, resulting in increased latency and decreased throughput.

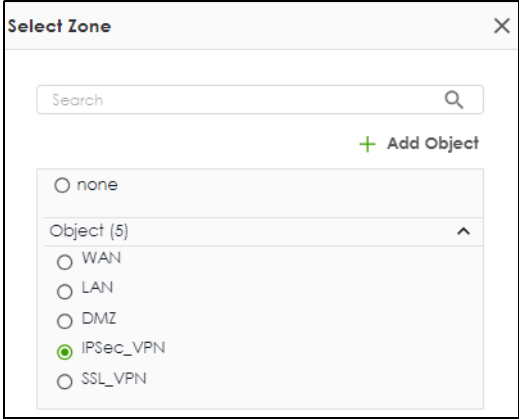
Table 101 VPN > Site-to-Site VPN > Add/Edit > Scenario > Type > Custom (continued)

LABEL	DESCRIPTION
Authentication	Select which hash algorithm to use to authenticate packet data in the IPsec SA. Choices are hmac-md5 , hmac-sha1 , hmac-sha256 , hmac-sha384 and hmac-sha512 . SHA is generally considered stronger than MD5 , but it is also slower. The Zyxel Device and the remote IPsec router must both have a proposal that uses the same authentication algorithm.
Perfect Forward Secrecy (PFS)	Select which Perfect Forward Secrecy (PFS) you want to use to create encryption keys. Choices are DH2 , DH5 , DH14 , DH15 , DH16 , DH19 , DH20 , DH21 , DH28 , DH29 , and DH30 . The longer the key, the more secure the encryption, but also the longer it takes to encrypt and decrypt information. The Zyxel Device and the remote IPsec router must use the same DH key group. See Section 12.2 on page 188 for more information on DH key group.
Advanced Settings	
NAT Rule	This is available if the VPN type is Policy-based .
Add	Click this to add an entry.
Edit	Select an entry and click this to edit the entry.
Remove	Select an entry and click this to remove the entry.
Pri.	Select the priority for the entry. The smaller the number, the higher the priority.
Origin IP	Select the address object that represents the originating destination address. IP address of the sender in the remote network.
Type	SNAT : Select this when there are no overlapping local and remote VPN IP addresses. 1:1 NAT : Select this to avoid overlapping local and remote VPN IP addresses. The peer IPsec router must create identical mirror configurations.
Mapped IP	SNAT : Enter an IP address in the local IP address range to map the sender's source IP address for the VPN rule. 1:1 NAT : Enter an IP address or subnet in the Local IP address range to map the sender's source IP address or subnet for the VPN rule (SNAT). The local IP address range must not conflict with the peer's local IP address range. In the peer IPsec router, the destination IP from the sender is mapped to the local IP address of the receiver (DNAT).
Apply	Click Apply to save your settings to the Zyxel Device.
Cancel	Click Cancel to return to the profile summary page without saving any changes.

12.3.2.1 Policy-Based VPN NAT Advanced Scenarios

The following are application scenarios for SNAT and 1-1 NAT.

SNAT VPN Scenario

Here is an example of SNAT VPN scenario. Use this when there are no overlapping local and remote VPN IP addresses. Map the source IP address of the sender to an IP address in the Local IP address range (in the **Mapped IP** field) for the VPN rule. The headquarters (**HQ**) and branch sites **A** and **B** need to access the remote datacenter (**D**). The source IP addresses of sites **A** and **B** are not in the range of the local policy's IP address (192.168.168.0/24) for Phase 2. NAT rules need to be configured to translate the source IP addresses of sites **A** and **B** to an IP address in the 192.168.168.0/24 range before entering the IPsec tunnel.

Figure 151 Policy Based VPN - SNAT Example Scenario

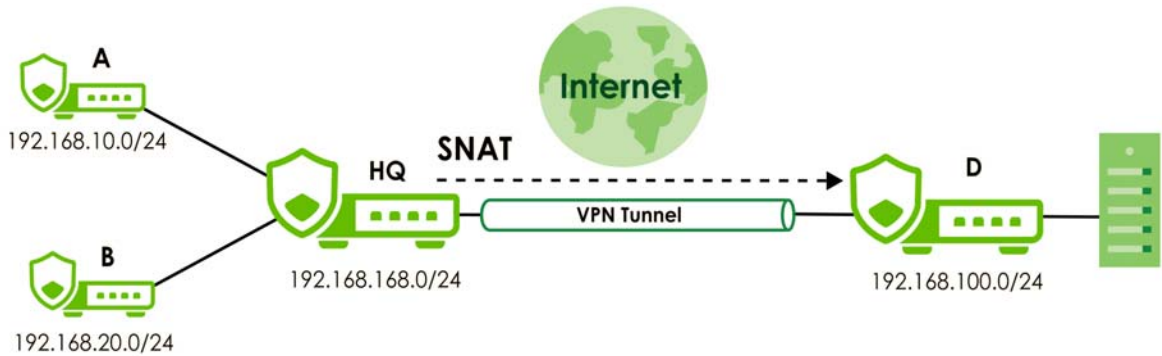

The administrator need to set up VPN policy on both sites.

Table 102 Phase 2 Local/Remote Policy Settings Example

LOCAL POLICY	REMOTE POLICY
192.168.168.0/24	192.168.100.0/24

Table 103 Phase 2 NAT Rule Settings Example

SITE	TYPE	ORIGIN IP	MAPPED IP
Site A	SNAT	192.168.10.0/24	192.168.168.11/32
Site B	SNAT	192.168.20.0/24	192.168.168.12/32

1-1 NAT VPN Scenario

Here is an example of a 1:1 NAT VPN scenario. Use this to avoid overlapping local and remote VPN IP addresses. IPsec router **A** and IPsec router **B** need to access each other, but they have overlapping subnets. To avoid conflicts, both IPsec routers need to create identical 1:1 NAT rules that map their local subnet to a non-overlapping subnet.

In the following example, IPsec router **A** is sending traffic to router **B**. Before data entering the VPN tunnel, the source IP address (set in **Origin IP**) from router **A** is translated to a mapped IP address (set in **Mapped IP**). After data exiting the VPN tunnel, router **B** translates the destination IP address (set in **Mapped IP**) back to the **Origin IP**.

Note: The **Mapped IP** of IPsec router **A** and **B** must not be in conflict.

Figure 152 Policy Based VPN - 1:1 NAT Example Scenario

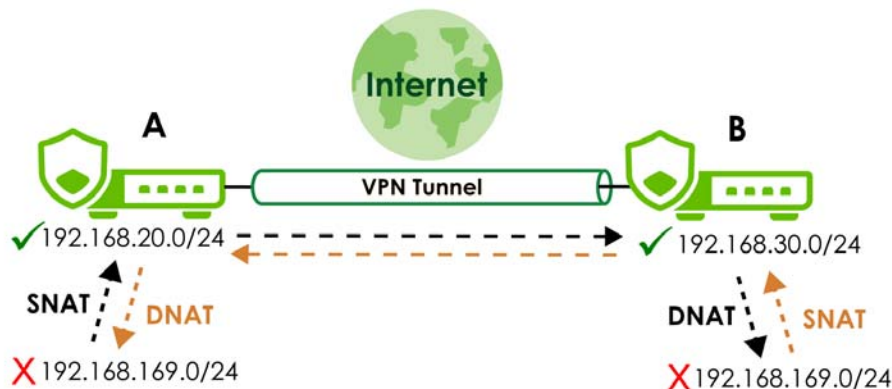

The administrator need to set up VPN policy on both sites.

Table 104 Phase 2 Local/Remote Policy Settings Example

SITE	LOCAL POLICY	REMOTE POLICY
Site A	192.168.20.0/24	192.168.30.0/24
Site B	192.168.30.0/24	192.168.20.0/24

Table 105 Phase 2 NAT Rule Settings Example

SITE	TYPE	ORIGIN IP	MAPPED IP
Site A	1:1 NAT	192.168.169.0/24	192.168.20.0/24
Site B	1:1 NAT	192.168.169.0/24	192.168.30.0/24

12.4 The Remote Access VPN Screen

Configure the settings in this screen to create a new or edit an existing remote access VPN rule to securely access the Zyxel Device local networks from anywhere. See [Section 12.1 on page 187](#) for more information on phase 1 and phase 2 settings; see [Section 12.2 on page 188](#) for more information on IKE SA proposals.

SecuExtender is a Zyxel subscription-based VPN client. A remote access VPN client must have SecuExtender VPN client installed on his device and uses a supported computer operating system.

Make sure the settings configured on the IPsec VPN client matches the settings you configured on the Zyxel Device.

Click **VPN > IPsec VPN > Remote Access VPN** to open the following screen.

Figure 153 VPN > IPsec VPN > Remote Access VPN

General Settings

Zyxel's remote VPN solution uses leading IPsec/IKEV2 (EAP-MSCHAPv2) encryption, supported by SecuExtender VPN Client. You can also use native clients built into Windows, Android, macOS and iOS.

Enable

Get SecuExtender VPN Client Software

VPN Configuration Download for Native VPN Client

Incoming Interface

Interface

Domain Name / IP

NAT Traversal

Zone

Certificate for VPN Validation

Auto

Manual

Clients will use VPN to access

Internet and Local Networks (Full Tunnel)

Auto SNAT

Local Networks Only (Split Tunnel)

Local Network

Client Network

IP Address Pool

First DNS Server ZyWALL

Custom Defined

Second DNS Server

Authentication

Primary Server

Secondary Server

User

Advanced Settings

Phase 1 Settings

SA Life Time (180 - 3000000 Seconds)

[+ Add](#) [Remove](#)

Encryption	Authentication
<input type="checkbox"/> AES128	SHA256

Diffie-Hellman Groups

Phase 2 Settings

SA Life Time (180 - 3000000 Seconds)

[+ Add](#) [Remove](#)

Encryption	Authentication
<input type="checkbox"/> AES128	SHA256

Perfect Forward Secrecy (PFS)

The following table describes the labels in this screen.

Table 106 VPN > IPsec VPN > Remote Access VPN

LABEL	DESCRIPTION
Enable	Click the switch to enable the remote access VPN rule.
Get SecuExtender VPN Client Software	Click to download SecuExtender to your computer. The supported operating systems for SecuExtender are: <ul style="list-style-type: none"> Windows 10 (64-bit) and later versions. macOS 10.15 and later versions.
VPN configuration script download	Click to download a VPN configuration script to send to clients using IPsec VPN clients built into the operating systems. To use the download script, the built-in IPsec VPN clients need to use the following operating systems: <ul style="list-style-type: none"> Clients using Windows 7 and later, iOS and macOS built-in IPsec VPN clients can import the VPN configuration script to configure a remote access VPN rule automatically. Click the link to download the script and send it to them. Clients using Android should download the latest version strongSwan VPN client, then import the script to configure a remote access VPN rule automatically. Click the link to download the script and send it to them. Clients using built-in IPsec VPN clients earlier than Windows 7 cannot use the script. They must configure a remote access VPN rule manually. Send the Pre-Shared Key and the Zyxel Device interface IP or domain name to them.
Incoming Interface	
Interface	Select an interface from the drop-down list box for incoming traffic to your Zyxel Device.
Domain Name/IP	Enter the domain name if you are using DDNS to assign the interface a dynamic IP address (for example, vpn.zyxel.com). Enter the IPv4 address if you are using a static IP address.
NAT Traversal	If the Zyxel Device is behind a NAT router, enter the public IP address or the domain name that is configured and mapped to the Zyxel Device on the NAT router. Note: To allow a site-to-site VPN connection, the NAT router must have the following ports open: UDP 500, 4500.
Zone	Select the security zone into which to add this VPN connection policy. Any security rules or settings configured for the selected zone apply to this VPN connection policy.
Certificate for VPN Validation	
Auto	Select Auto to have the Zyxel Device generate a certificate from the current remote access VPN settings. This is the certificate the Zyxel Device uses to identify itself when setting up the VPN tunnel.
Manual	Select Manual to use an existing certificate from the drop-down list box.
Local Network	
Full Tunnel	Select Full Tunnel to encrypt all traffic through the VPN. Select Allow Client VPN Traffic Through WAN to allow only traffic encrypted by the Zyxel Device from the remote client to the Internet.
Split Tunnel	Select Split Tunnel to only encrypt traffic going to networks behind the Zyxel Device. Enter an IPv4 address in CIDR notation, for example, type 192.168.1.1/24. Traffic going to the Internet from this IP address is encrypted. Traffic going to the Internet from the remote client does not go through the Zyxel Device is not encrypted.
Client Network	

Table 106 VPN > IPsec VPN > Remote Access VPN (continued)

LABEL	DESCRIPTION
IP Address Pool	<p>Enter an IPv4 address in CIDR notation, for example, type 192.168.1.1/24. The IP address pool is used to assign IP addresses to the VPN clients.</p> <p>The SSL VPN IP pool should not overlap with IP addresses on the Zyxel Device's local networks and the SSL user's network.</p>
First DNS Server	<p>Specify the IP address of the DNS server whose information the Zyxel Device sends to the remote users. This allows them to access devices on the local network using domain names instead of IP addresses.</p> <p>ZyWALL- the VPN clients use the IP address of the interface you specified in the SSL VPN rule and the Zyxel Device works as a DNS relay.</p> <p>Custom Defined- enter a static IPv4 address</p>
Second DNS Server	Enter a secondary DNS server IP address that is checked if the first one is unavailable.
Authentication	
Primary/ Secondary Server	Select a specified RADIUS server from the drop-down list box for the Zyxel Device to use for authentication.
User	Select a user or user group to associate the user or user group to this remote access IPsec VPN policy.
Advanced Settings	
SA Life Time	<p>Set how often the Zyxel Device renegotiates the IKE SA. A short SA life time increases security, but renegotiation temporarily disconnects the VPN tunnel.</p> <p>The value you set for the SA life time in Phase 2 Settings should be lesser than or equal to the value you set for the SA life time in Phase 1 Settings.</p>
Add	Click this to add an entry.
Edit	Select an entry and click this to edit the entry.
Remove	Select an entry and click this to remove the entry.
Encryption	<p>Select which key size and encryption algorithm to use in the IPsec SA. Choices are:</p> <p>des-cbc - a 56-bit key with the DES encryption algorithm</p> <p>3des-cbc - a 168-bit key with the DES encryption algorithm</p> <p>aes128-cbc - a 128-bit key with the AES encryption algorithm</p> <p>aes192-cbc - a 192-bit key with the AES encryption algorithm</p> <p>aes256-cbc - a 256-bit key with the AES encryption algorithm</p> <p>The Zyxel Device and the remote IPsec router must both have at least one proposal that uses the same encryption and the same key.</p> <p>Longer keys are more secure, but require more processing power, resulting in increased latency and decreased throughput.</p>
Authentication	<p>Select which hash algorithm to use to authenticate packet data in the IPsec SA. Choices are hmac-md5, hmac-sha1, hmac-sha256, hmac-sha384 and hmac-sha512. SHA is generally considered stronger than MD5, but it is also slower.</p> <p>The Zyxel Device and the remote IPsec router must both have a proposal that uses the same authentication algorithm.</p>

Table 106 VPN > IPsec VPN > Remote Access VPN (continued)

LABEL	DESCRIPTION
Diffie-Hellman Groups	<p>Select which Diffie-Hellman key group (DHx) you want to use to create encryption keys. Choices are DH2, DH5, DH14, DH15, DH16, DH19, DH20, DH21, DH28, DH29, and DH30.</p> <p>The longer the key, the more secure the encryption, but also the longer it takes to encrypt and decrypt information. The Zyxel Device and the remote IPsec router must use the same DH key group. See Section 12.2 on page 188 for more information on DH key group.</p> <p>Different operating systems may support different DH key groups. Check your operating system documentation.</p> <ul style="list-style-type: none"> For Windows VPN clients, Zyxel SecuExtender perpetual VPN clients versions 3.8.203.61.32 and earlier support DH1 to DH14. For macOS VPN clients, Zyxel SecuExtender subscription VPN clients versions 1.2.0.7 and later support DH14 to DH21. For Windows VPN clients, Zyxel SecuExtender subscription VPN clients versions 5.6.80.007 and later support DH14 to DH21. Windows versions 7, 10, 11 built-in IKEv2 VPN clients support DH2 by default. macOS versions 14.2 and later built-in IKEv2 VPN clients support DH14 by default. iOS versions 10.15 and later built-in IKEv2 VPN clients support DH14 by default.
Apply	Click Apply to save your changes back to the Zyxel Device.
Cancel	Click Cancel to return the screen to its last-saved settings.

12.5 Remote Access VPN Setup Example

In this example, user **R** is working from home and needs to access the office network behind the Zyxel Device in the office. An administrator first configures the VPN settings on the Zyxel Device, then he provides user **R** with the necessary VPN authentication details, so that user **R** can establish a VPN connection to the office network from their computer at home.

Figure 154 Remote Access VPN Example Topology

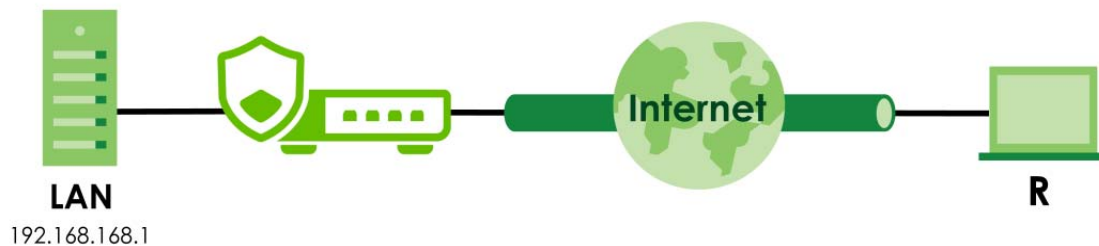

See the following table for VPN types and remote software options.

Table 107 SSL / IKEv2 VPN Comparison

VPN TYPE	FEATURE	HOME USER SOFTWARE	SUPPORTED OPERATING SYSTEMS	AUTHENTICATION REQUIREMENTS
SSL	Provides high security. May have lower connection speed and stability.	OpenVPN Connect	Windows, macOS, Linux, iOS, Android	<ul style="list-style-type: none"> VPN account username and password OVPN configuration file
		SecuExtender	Windows, macOS	<ul style="list-style-type: none"> VPN account username and password

Table 107 SSL / IKEv2 VPN Comparison (continued)

VPN TYPE	FEATURE	HOME USER SOFTWARE	SUPPORTED OPERATING SYSTEMS	AUTHENTICATION REQUIREMENTS
IKEv2	Provides high security, connection speed and stability.	The IPsec VPN Client on Your Computer	Windows, macOS, iOS, and Android (strongSwan)	<ul style="list-style-type: none"> VPN account username and password Configuration file
		SecuExtender	Windows, macOS	<ul style="list-style-type: none"> VPN account username and password

12.5.1 Zyxel Device Setup

Select [SSL](#) or [IKEv2](#) to configure the Zyxel Device in the office. See [Table 107 on page 213](#) for the comparison between two VPN types.

SSL

- 1 Go to **User & Authentication > User/Group > User**, and click **Add** under **User** to create a VPN user account.

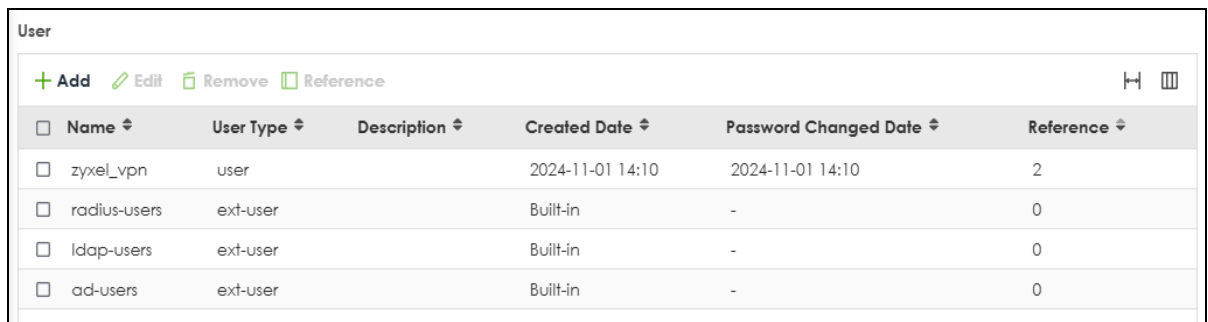

The screenshot shows the 'User' management page. At the top, there are action buttons: '+ Add', 'Edit', 'Remove', and 'Reference'. Below these is a table with the following columns: Name, User Type, Description, Created Date, Password Changed Date, and Reference. The table contains four rows of user data.

Name	User Type	Description	Created Date	Password Changed Date	Reference
zyxel_vpn	user		2024-11-01 14:10	2024-11-01 14:10	2
radius-users	ext-user		Built-in	-	0
ldap-users	ext-user		Built-in	-	0
ad-users	ext-user		Built-in	-	0

- 2 Set a VPN user name and password, then click **Apply** to save your changes. Note down the account name and password for the home user who will use this for future remote access authentication.

The screenshot displays the 'User & Authentication' configuration page for a user named 'zyxel_vpn'. The page is divided into two main sections: 'Profile Management' and 'Two-factor Authentication'. In the 'Profile Management' section, the 'User Name' is 'zyxel_vpn', 'User Type' is 'User', and both 'Password' and 'Retype' fields are masked with dots. There are empty input fields for 'Description', 'Email 1', 'Email 2', and 'Mobile Number'. Under 'Authentication Timeout Settings', 'Use Default Settings' is selected, and both 'Lease Time' and 'Reauthentication Time' are set to 1440 minutes. The 'Two-factor Authentication' section has a toggle switch for 'Enable Two-Factor Authentication for VPN Access' which is currently turned off. A green notification box at the bottom right states 'Some changes were made' and asks 'What do you want to do then?', with 'Cancel' and 'Apply' buttons.

- 3 To configure SSL VPN on the Zyxel Device, go to **VPN > SSL VPN**.

VPN > SSL VPN

General Settings

Zyxel Remote VPN works with the SecuExtender VPN client and is also compatible with the OpenVPN Connect client.

Enable

SSL VPN Configuration Download [Download](#)

Incoming Interface

Interface:

DNS Name: (Optional)

Server Port:

Zone:

Clients will use VPN to access

Internet and Local Networks (Full Tunnel)

Auto SNAT

Local Networks Only (Split Tunnel)

Client Network

IP Address Pool:

First DNS Server: ZyWALL Custom Defined

Second DNS Server:

Authentication

Primary Server:

Secondary Server:

User:

[Advanced Settings](#)

Some changes were made
What do you want to do then?
[Cancel](#) [Apply](#)

Follow the table below to configure the **VPN > SSL VPN** screen.

Table 108 SSL VPN Screen Configuration

LABEL	DESCRIPTION
Enable	Click this to the right to enable SSL VPN.
Interface	Select an interface for incoming traffic to your Zyxel Device.
Clients will use VPN to access	<p>Full Tunnel - Select this to encrypt all traffic through the VPN.</p> <p>Split Tunnel - Select this to only encrypt traffic going to networks behind the Zyxel Device. Enter an IPv4 address in CIDR notation, for example, type IP address 192.168.51.0/24. Traffic going to the Internet from this IP address is encrypted, and not encrypt traffic going to the Internet through the Zyxel Device.</p>
User	Select the user account you created in step 2 to allow SSL VPN access

- Click **Apply** to save the changes.
- To allow the Zyxel Device to access VPN traffic from WAN, go to **Object > Service > Service Group**. Select **Default_Allow_WAN_To_ZyWALL** and click **Edit**.

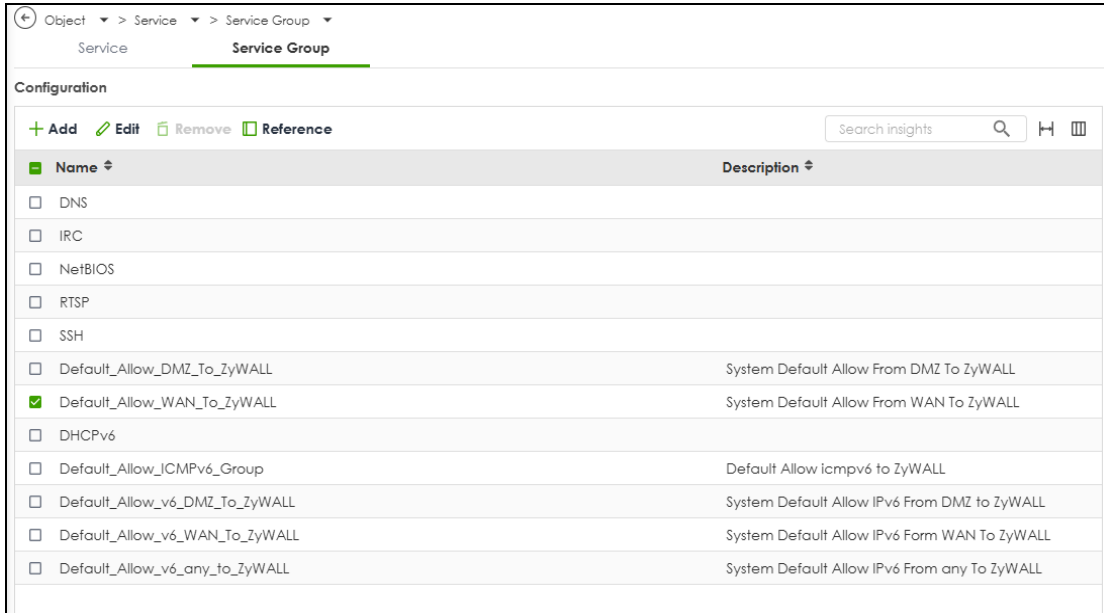

- 6 Search for **SSL VPN** under **Available** and click **>** to add it to the allow list of traffic from the WAN to the Zyxel Device. Then, click **Apply** to save the changes.

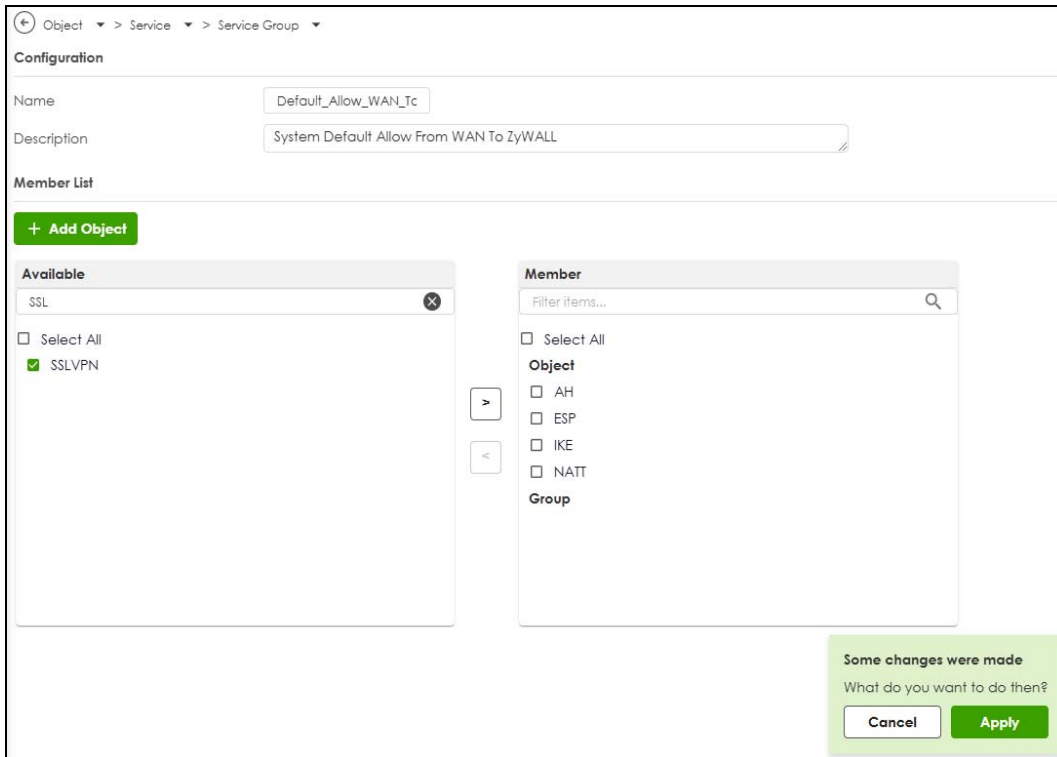

IKEv2

- 1 Go to **User & Authentication > User/Group > User**, and click **Add** under **User** to create a VPN user account.

User						
+ Add Edit Remove Reference						
<input type="checkbox"/>	Name ↕	User Type ↕	Description ↕	Created Date ↕	Password Changed Date ↕	Reference ↕
<input type="checkbox"/>	zyxel_vpn	user		2024-11-01 14:10	2024-11-01 14:10	2
<input type="checkbox"/>	radius-users	ext-user		Built-in	-	0
<input type="checkbox"/>	ldap-users	ext-user		Built-in	-	0
<input type="checkbox"/>	ad-users	ext-user		Built-in	-	0

- Set a VPN user name and password, then click **Apply** to save your changes. Note down the account name and password for future remote access authentication.

User & Authentication > User/Group > User

Profile Management

User Name:

User Type:

Password:

Retype:

Description:

Email 1:

Email 2:

Mobile Number:

Authentication Timeout Settings:
 Use Default Settings
 Use Manual Settings

Lease Time: 1440 minutes

Reauthentication Time: 1440 minutes

Two-factor Authentication

Enable Two-Factor Authentication for VPN Access:

Some changes were made

What do you want to do then?

- To configure IKEv2 VPN on the Zyxel Device, go to **VPN > IPsec VPN > Remote Access VPN** and enable IKEv2 VPN.

Follow the table below to configure the **VPN > IPsec VPN > Remote Access VPN** screen.

Table 109 IKEv2 VPN Screen Configuration

LABEL	DESCRIPTION
Enable	Click this to the right to enable SSL VPN.
Interface	Select an interface for incoming traffic to your Zyxel Device.
Clients will use VPN to access	<p>Internet and Local Networks (Full Tunnel) - Select this to encrypt all traffic through the VPN.</p> <p>Local Networks Only (Split Tunnel) - Select this to only encrypt traffic going to networks behind the Zyxel Device. Enter an IPv4 address in CIDR notation, for example, type IP address 192.168.51.0/24. Traffic going to the Internet from this IP address is encrypted, and not encrypt traffic going to the Internet through the Zyxel Device.</p>
User	Select the user account you created in step 2 to allow IKEv2 VPN access

- 4 Click **Apply** to save your changes.
- 5 Send authentication details to the home user.

12.5.2 Home User Setup

The administrator has now finished setting up the VPN configuration on the Zyxel Device. Now, the home user needs to set up a VPN client software on their computer or mobile device to connect to the office network. See [Table 107 on page 213](#) for VPN software options for home user and more details.

SecuExtender

SecuExtender is a Zyxel subscription-based VPN client.

Home users using SecuExtender need the following:

- The SecuExtender VPN client software: They should get this from the Zyxel Device administrator, who downloads it from the **VPN > IPsec VPN > Remote Access VPN > Get SecuExtender VPN Client Software** screen. Alternatively, you can download it directly from the Zyxel website.
- VPN account username and password: They should get this from the Zyxel Device administrator, who sets it in the **User & Authentication > User/Group > User** screen.

Follow these steps to establish a VPN connection to the office's network through SecuExtender:

- 1 Unzip, install, and open the SecuExtender VPN Client on your computer. Click **Configuration > Get from Server**, then enter the parameters as described below and click **Next**.

LABEL	DESCRIPTION
Gateway Address	Enter the WAN IP address of the Zyxel Device.
Authentication	Set as Login + Password .
Login/Password	Enter the username and password the Zyxel Device administrator gave.

- 2 The following screen appears, click **OK**.

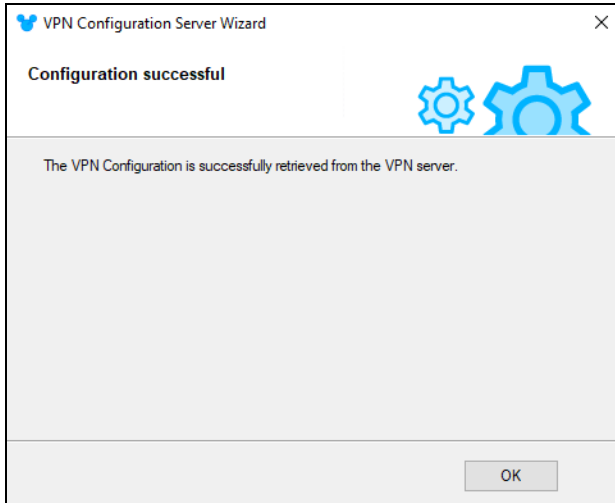

- Right click on the VPN policy you just created, then click **Open tunnel** to establish a remote VPN connection.

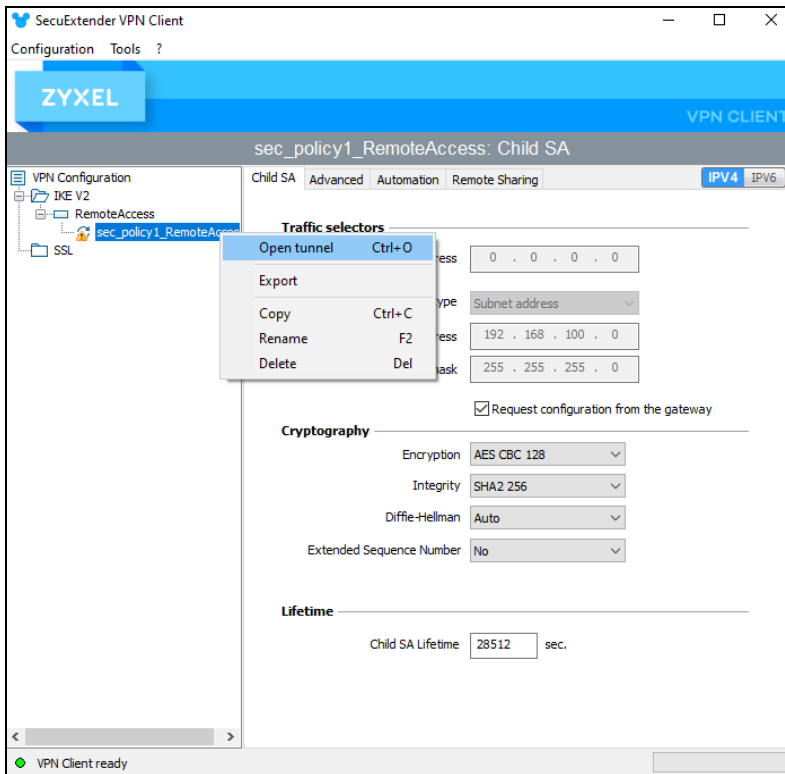

- Re-enter the user name and password, then click **OK**. The icon next to the VPN policy turns green. You can now access the office network through the Zyxel Device.

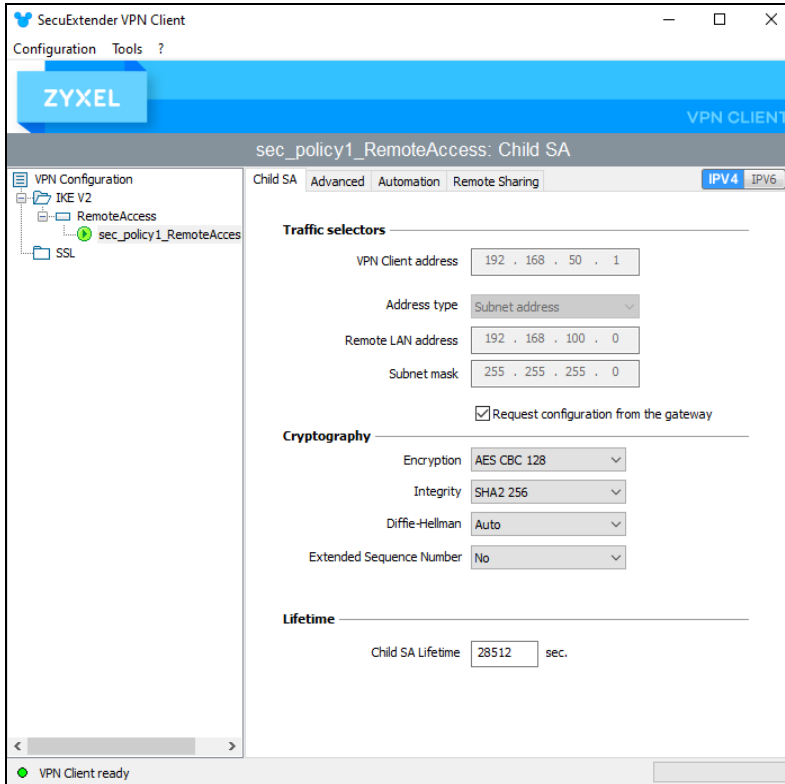

OpenVPN Connect

Follow these steps to establish a VPN connection to the office's network through OpenVPN Connect:

- 1 Home users using OpenVPN Connect need the following:
 - The OpenVPN Connect client software.
 - The VPN account username and password: They should get this from the Zyxel Device administrator, who sets it in the **User & Authentication > User/Group > User** screen.
 - The OVPN configuration file: They should get this from the Zyxel Device administrator, who downloads it from the **VPN > SSL VPN** screen.
- 2 Go to the [OpenVPN Connect](#) website and download the OpenVPN Connect client for your computer's operation system.

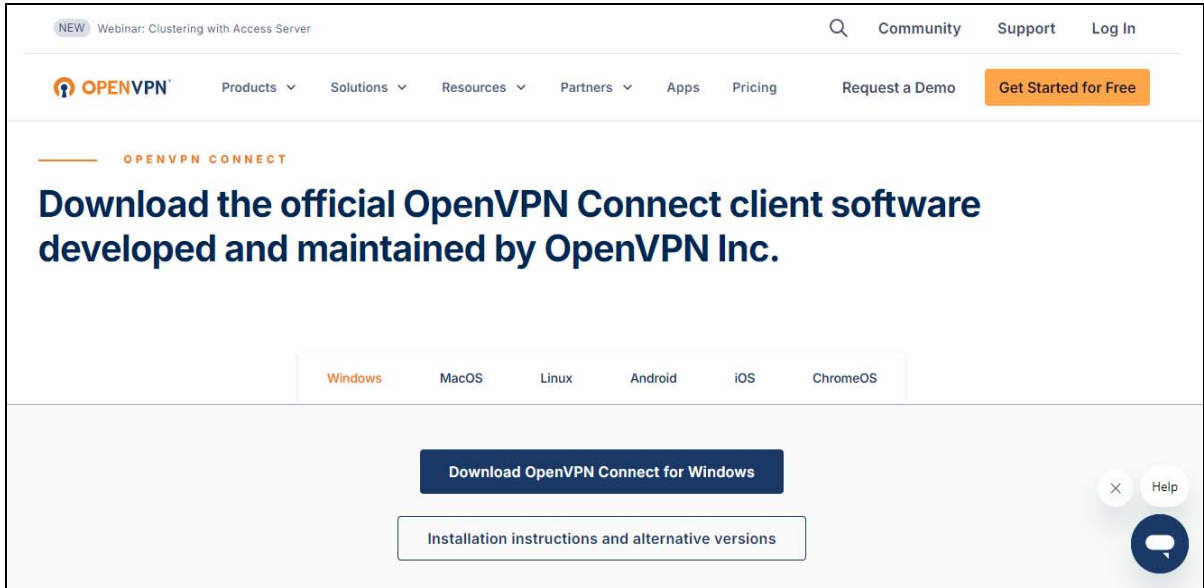

- 3 Run the OpenVPN Connect client on your computer. Click **Browse** and import the .OVPN file provided by Zyxel Device administrator.

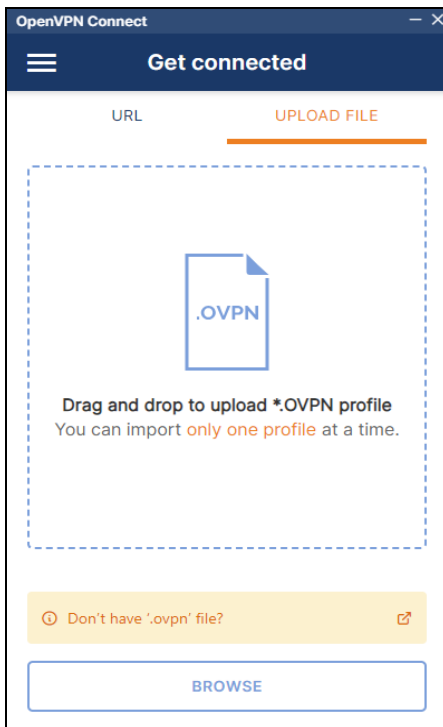

- 4 In the **Username** field, enter the VPN user name the Zyxel Device administrator set. Click **Connect** to connect your computer to the office network.

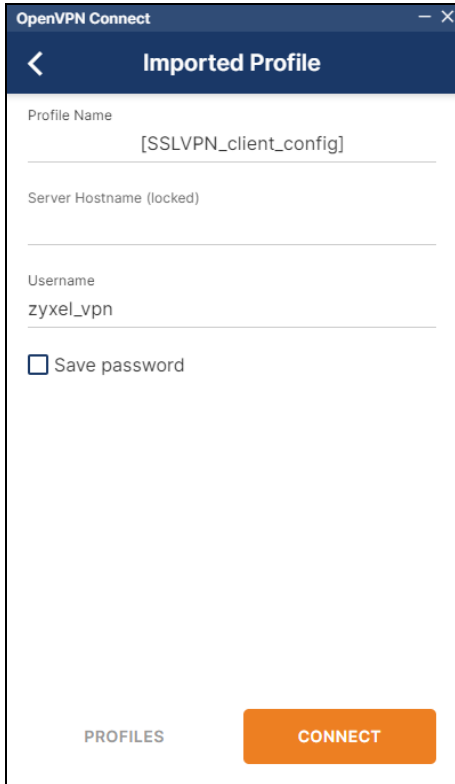

- 5 Enter the VPN user password provided by the Zyxel Device administrator.

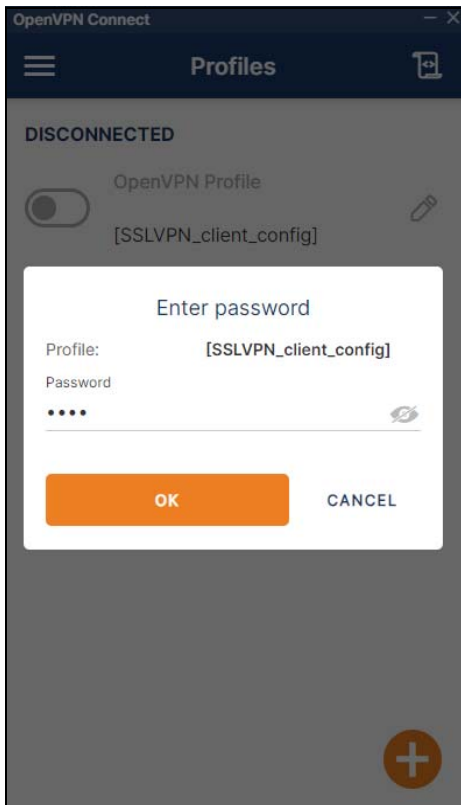

- 6 Your home computer can now access the office network through the Zyxel Device.

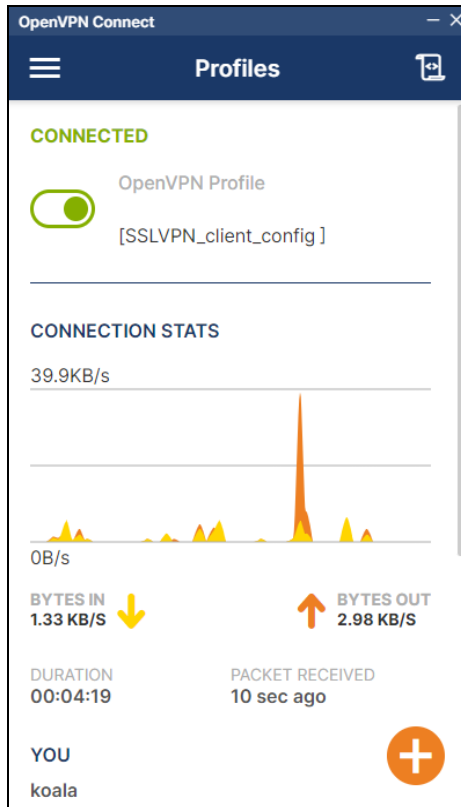

The IPsec VPN Client on Your Computer

Use the built-in VPN client in Windows, macOS, iOS, or Android (strongSwan).

Home users using the IPsec VPN client on their computers need the following:

- Configuration file: They should get this from the Zyxel Device administrator, who downloaded it from the **VPN > IPsec VPN > Remote Access VPN** screen.

Follow these steps to establish a VPN connection to the office's network through the IPsec VPN client on a computer with a Windows operating system:

- 1 Obtain the configuration file, VPN account name and password from the Zyxel Device administrator.
- 2 Unzip and open the configuration file, then double-click on the .bat file to set up the certificate for the VPN connection.

Name	Date modified	Type	Size
Readme	14/11/2024 18:26	Text Document	1 KB
RemoteAccess_Win_RemoteAccess	14/11/2024 18:26	Windows Batch File	3 KB
RemoteAccess_Win_RemoteAccess	14/11/2024 18:26	Security Certificate	1 KB

- 3 A command-line interface will appear, showing the status of the VPN connection. To connect to the office network, click the **Internet access** icon, then click **Connect** next to the **RemoteAccess** network.

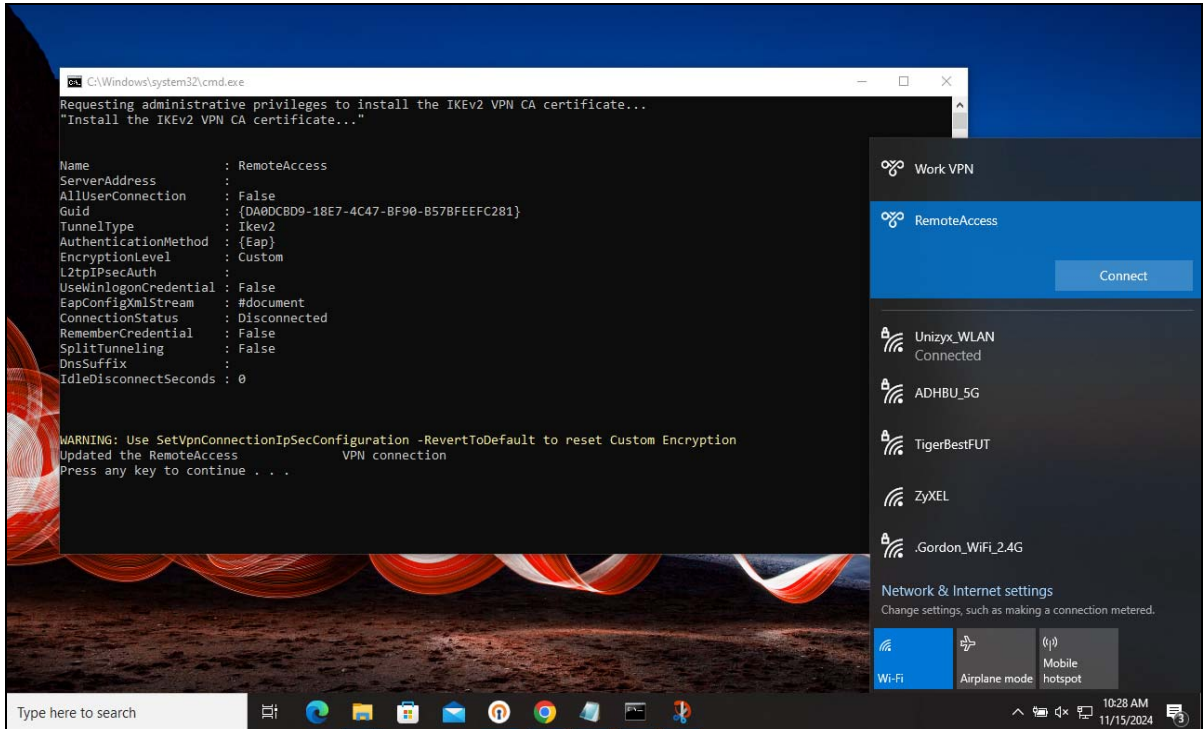

- 4 Enter the username and password provided by the administrator in the pop-up window, then click **OK**.

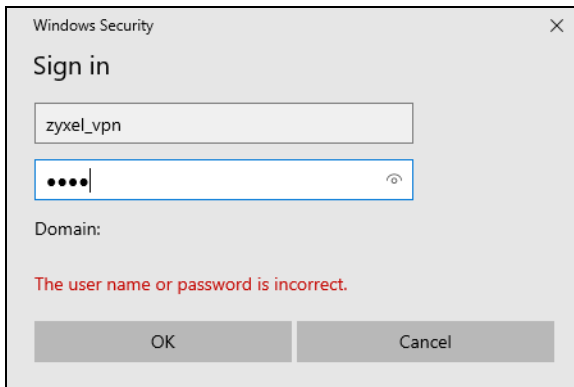

- 5 The following screen indicates you are now connected to the office network.

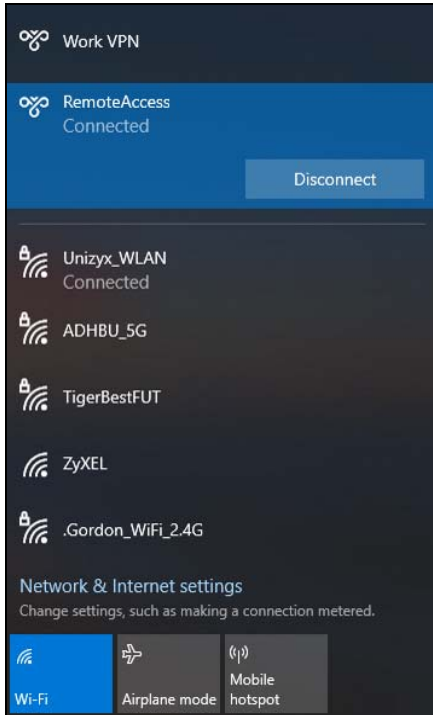

12.5.3 Test the VPN Connection

To test if the home user's computer can successfully connect to the office's network, they should open the Command Prompt and ping the IP address of a device in the LAN. If the connection is successful, the following result will appear.

```
Command Prompt
Microsoft Windows [Version 10.0.19045.5073]
(c) Microsoft Corporation. All rights reserved.

C:\Users\NT03315>ping 192.168.168.1

Pinging 192.168.168.1 with 32 bytes of data:
Reply from 192.168.168.1: bytes=32 time<1ms TTL=64
Reply from 192.168.168.1: bytes=32 time<1ms TTL=64
Reply from 192.168.168.1: bytes=32 time<1ms TTL=64
Reply from 192.168.168.1: bytes=32 time<1ms TTL=64

Ping statistics for 192.168.168.1:
    Packets: Sent = 4, Received = 4, Lost = 0 (0% loss),
    Approximate round trip times in milli-seconds:
        Minimum = 0ms, Maximum = 0ms, Average = 0ms

C:\Users\NT03315>
```

CHAPTER 13

SSL VPN

13.1 Overview

Use SSL VPN to allow users to use a web browser for secure remote user login. The remote users do not need a VPN router or VPN client software.

13.1.1 What You Can Do in this Chapter

Use the **VPN > SSL VPN** screens (see [Section 13.2 on page 229](#)) to configure a SSL access policy.

13.1.2 What You Need to Know

Full Tunnel Mode

In full tunnel mode, a virtual connection is created for remote users with private IP addresses in the same subnet as the local network. This allows them to access network resources in the same way as if they were part of the internal network.

Figure 155 Network Access Mode: Full Tunnel Mode

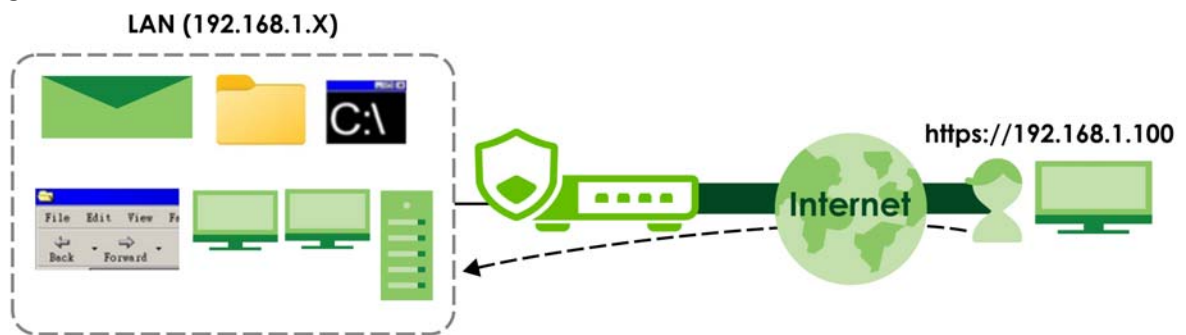

Split Tunnel Mode

In split tunnel mode, only the traffic going to the networks behind the Zyxel Device is encrypted. Traffic going to the Internet from the remote client does not go through the Zyxel Device and is not encrypted.

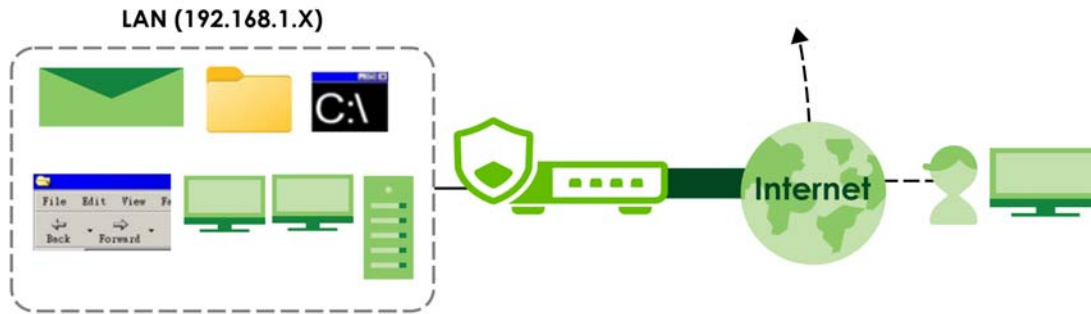
Figure 156 Network Access Mode: Split Tunnel Mode

SSL VPN Policy

An SSL VPN policy allows the Zyxel Device to perform the following tasks:

- limit user access to specific applications or file sharing server on the network.
- allow user access to specific networks.
- assign private IP addresses and provide DNS/WINS server information to remote users to access internal networks.

SSL Access Policy Objects

The SSL access policies reference the following objects. If you update this information, in response to changes, the Zyxel Device automatically propagates the changes through the SSL policies that use the object(s). When you delete an SSL policy, the objects are not removed.

Table 110 Objects

OBJECT TYPE	OBJECT SCREEN	DESCRIPTION
User Accounts	User Account/ User Group	Configure a user account or user group to which you want to apply this SSL access policy.
Application	SSL Application	Configure an SSL application object to specify the type of application and the address of the local computer, server, or web site SSL users are to be able to access.
IP Pool	Address	Configure an address object that defines a range of private IP addresses to assign to user computers so they can access the internal network through a VPN connection.
Server Addresses	Address	Configure address objects for the IP addresses of the DNS and WINS servers that the Zyxel Device sends to the VPN connection users.
VPN Network	Address	Configure an address object to specify which network segment users are allowed to access through a VPN connection.

Please note that you cannot delete an object that is referenced by other settings.

13.2 The SSL VPN Screen

Configure the settings in this screen to create a new or edit an existing SSL access policy.

SecuExtender is a Zyxel subscription-based VPN client. A remote access VPN client must have SecuExtender VPN client installed on his device and uses a supported computer operating system. The supported computer operating systems are:

- Window 10 (64-bit) and later versions.
- macOS 10.15 and later versions.

Make sure the settings configured on the SSL VPN client matches the settings you configured on the Zyxel Device.

Click **VPN > SSL VPN** to open the following screen.

Figure 157 VPN > SSL VPN

Zyxel Remote VPN works with the SecuExtender VPN client and is also compatible with the OpenVPN Connect client.

Enable

SSL VPN Configuration Script Download [Download](#)

Incoming Interface

Interface: any

DNS Name: (Optional)

Server Port: 10443

Local Network

Full Tunnel Split Tunnel

+ Add Edit Remove

Network

No data

Client Network

IP Address Pool: 1.1.1.0/24

First DNS Server: ZyWALL Custom Defined

Second DNS Server:

Authentication

Primary Server: local

Secondary Server: none

User: any

Advanced Settings

^

[Generate Certificate](#)

Some changes were made
What do you want to do then?
[Cancel](#) [Apply](#)

The following table describes the labels in this screen.

Table 111 VPN > SSL VPN

LABEL	DESCRIPTION
Enable	Click the switch to enable the SSL access policy.
Download	Click to download a VPN configuration script to send to clients using SecuExtender VPN client or OpenVPN Connect VPN client. The supported operating systems for SecuExtender are: <ul style="list-style-type: none"> Windows 10 (64-bit) and later versions. macOS 10.15 and later versions.
Incoming Interface	
Interface	Select an interface from the drop-down list box for incoming traffic to your Zyxel Device.
DNS Name	Enter the domain name (for example, vpn.zyxel.com) if you're using DDNS to assign the interface a dynamic IP address.
Server Port	Specify the server port of the Zyxel Device for full tunnel mode SSL VPN access. Leave this field to default settings unless it conflicts with another interface.
Local Network	
Full Tunnel	Select Full Tunnel to encrypt all traffic through the VPN. Select Allow Client VPN Traffic Through WAN to allow only traffic encrypted by the Zyxel Device from the remote client to the Internet.
Split Tunnel	Select Split Tunnel to only encrypt traffic going to networks behind the Zyxel Device. Enter an IPv4 address in CIDR notation, for example, type 192.168.1.1/24. Traffic going to the Internet from this IP address is encrypted. Traffic going to the Internet from the remote client does not go through the Zyxel Device is not encrypted.
Client Network	
IP Address Pool	Enter an IPv4 address in CIDR notation, for example, type 192.168.1.1/24. The IP address pool is used to assign IP addresses to the VPN clients. The SSL VPN IP pool should not overlap with IP addresses on the Zyxel Device's local networks and the SSL user's network.
First DNS Server	Specify the IP address of the DNS server whose information the Zyxel Device sends to the remote users. This allows them to access devices on the local network using domain names instead of IP addresses. ZyWALL- the VPN clients use the IP address of the interface you specified in the SSL VPN rule and the Zyxel Device works as a DNS relay. Custom Defined- enter a static IPv4 address
Second DNS Server	Enter a secondary DNS server IP address that is checked if the first one is unavailable.
Authentication	
Primary/ Secondary Server	Select a specified RADIUS server from the drop-down list box for the Zyxel Device to use for authentication.
User	Select a user or user group to associate the user or user group to this SSL access policy.
Advanced Settings	

Table 111 VPN > SSL VPN (continued)

LABEL	DESCRIPTION
Generate Certificate	<p>Click the button to have the Zyxel Device generate a certificate from the current SSL VPN settings. This is the certificate the Zyxel Device uses to identify itself when setting up the SSL VPN tunnel.</p> <p>If you change the SSL VPN settings, the Generate Certificate button displays. Click Generate Certificate to generate a new certificate from the new SSL VPN settings. Please note that VPN clients cannot connect to the SSL VPN tunnel while the Zyxel Device is generating certificate.</p> <p>If you change the SSL VPN settings and generate a new certificate from the new SSL VPN settings, all connected SSL VPN clients have to update their SSL VPN settings so their SSL VPN settings match the Zyxel Device SSL VPN settings.</p>
Apply	Click Apply to save your changes back to the Zyxel Device.
Cancel	Click Cancel to exit this screen without saving.

CHAPTER 14

Security Policy

14.1 Overview

A security policy is a template of security settings that can be applied to specific traffic at specific times. The policy can be applied:

- to a specific direction of travel of packets (from / to)
- to a specific source and destination address objects
- to a specific type of traffic (services)
- to a specific user or group of users
- at a specific schedule

The policy can be configured:

- to allow or deny traffic that matches the criteria above
- send a log or alert for traffic that matches the criteria above
- to apply the actions configured in the profiles (application patrol, content filter, IDP, anti-malware, email security) to traffic that matches the criteria above

The security policies can also limit the number of user sessions.

The following example shows the Zyxel Device's default security policies behavior for a specific direction of travel of packets. WAN to LAN traffic and how stateful inspection works. A LAN user can initiate an SSH session from within the LAN zone and the Zyxel Device allows the response. However, the Zyxel Device blocks incoming SSH traffic initiated from the WAN zone and destined for the LAN zone.

Figure 158 Default Directional Security Policy Example

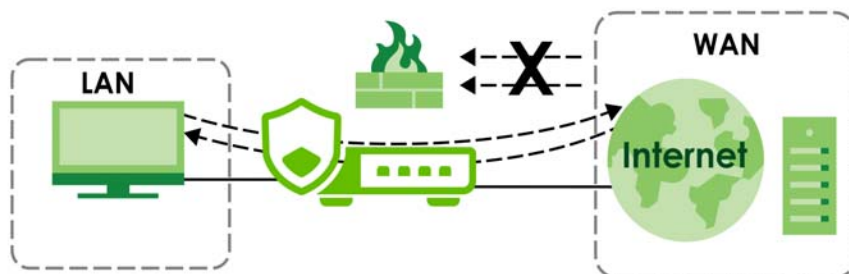

14.2 What You Can Do in this Chapter

- Use the **Policy Control** screens ([Section 14.3 on page 236](#)) to enable or disable policies, asymmetrical routes, and manage and configure policies.

- Use the **DoS Prevention** screens ([Section 14.4 on page 243](#)) to detect traffic with protocol anomalies and take appropriate action.
- Use the **IP Spoofing Prevention** screen ([Section 14.5 on page 249](#)) to bind IP addresses to MAC addresses.
- Use the **Session Control** screen ([Section 14.6 on page 251](#)) to limit the number of concurrent NAT/ Security Policy sessions a client can use.

14.2.1 What You Need to Know

Stateful Inspection

The Zyxel Device uses stateful inspection in its security policies. The Zyxel Device restricts access by screening data packets against defined access rules. It also inspects sessions. For example, traffic from one zone is not allowed unless it is initiated by a computer in another zone first.

Zones

A zone is a group of interfaces. Group the Zyxel Device's interfaces into different zones based on your needs. You can configure security policies for data passing between zones or even between interfaces.

Default Directional Security Policy Behavior

Security Policies can be grouped based on the direction of travel of packets to which they apply. Here is the The Zyxel Device has default Security Policy behavior for traffic going through the Zyxel Device in various directions.

Table 112 Directional Security Policy Behavior

FROM ZONE TO ZONE	BEHAVIOR
From any to Device	DHCP traffic from any interface to the Zyxel Device is allowed.
From LAN1 to any (other than the Zyxel Device)	Traffic from the LAN1 to any of the networks connected to the Zyxel Device is allowed.
From LAN2 to any (other than the Zyxel Device)	Traffic from the LAN2 to any of the networks connected to the Zyxel Device is allowed.
From LAN1 to Device	Traffic from the LAN1 to the Zyxel Device itself is allowed.
From LAN2 to Device	Traffic from the LAN2 to the Zyxel Device itself is allowed.
From WAN to Device	The default services listed in To-Device Policies are allowed from the WAN to the Zyxel Device itself. All other WAN to Zyxel Device traffic is dropped.
From any to any	Traffic that does not match any Security policy is dropped. This includes traffic from the WAN to any of the networks behind the Zyxel Device. This also includes traffic to or from interfaces that are not assigned to a zone (extra-zone traffic).

To-Device Policies

Policies with **Device** as the **To Zone** apply to traffic going to the Zyxel Device itself. By default:

- The Security Policy allows only LAN, or WAN computers to access or manage the Zyxel Device.
- The Zyxel Device allows DHCP traffic from any interface to the Zyxel Device.

- The Zyxel Device drops most packets from the WAN zone to the Zyxel Device itself and generates a log except for AH, ESP, GRE, HTTPS, IKE, NATT.

When you configure a Security Policy rule for packets destined for the Zyxel Device itself, make sure it does not conflict with your service control rule. The Zyxel Device checks the security policy before the service control rules for traffic destined for the Zyxel Device.

A **From Any To Device** direction policy applies to traffic from an interface which is not in a zone.

Global Security Policies

Security Policies with **from any** and/or **to any** as the packet direction are called global Security Policies. The global Security Policies are the only Security Policies that apply to an interface that is not included in a zone. The **from any** policies apply to traffic coming from the interface and the **to any** policies apply to traffic going to the interface.

Security Policy Rule Criteria

The Zyxel Device checks the schedule, user name (user's login name on the Zyxel Device), source IP address and object, destination IP address and object, IP protocol type of network traffic (service) and Security Service profile criteria against the Security Policies (in the order you list them). When the traffic matches a policy, the Zyxel Device takes the action specified in the policy.

User Specific Security Policies

You can specify users or user groups in Security Policies. For example, to allow a specific user from any computer to access a zone by logging in to the Zyxel Device, you can set up a policy based on the user name only. If you also apply a schedule to the Security Policy, the user can only access the network at the scheduled time. A user-aware Security Policy is activated whenever the user logs in to the Zyxel Device and will be disabled after the user logs out of the Zyxel Device.

14.3 The Security Policy Screen

Asymmetrical Routes

If an alternate gateway on the LAN has an IP address in the same subnet as the Zyxel Device's LAN IP address, return traffic may not go through the Zyxel Device. This is called an asymmetrical or "triangle" route. This causes the Zyxel Device to reset the connection, as the connection has not been acknowledged.

You can have the Zyxel Device permit the use of asymmetrical route topology on the network (not reset the connection). However, allowing asymmetrical routes may let traffic from the WAN go directly to the LAN without passing through the Zyxel Device. A better solution is to use virtual interfaces to put the Zyxel Device and the backup gateway on separate subnets. Virtual interfaces allow you to partition your network into logical sections over the same interface. See the chapter about interfaces for more information.

By putting LAN 1 and the alternate gateway (**A** in the figure) in different subnets, all returning network traffic must pass through the Zyxel Device to the LAN. The following steps and figure describe such a scenario.

- 1 A computer on the LAN1 initiates a connection by sending a SYN packet to a receiving server on the WAN.
- 2 The Zyxel Device reroutes the packet to gateway **A**, which is in **Subnet 2**.
- 3 The reply from the WAN goes to the Zyxel Device.
- 4 The Zyxel Device then sends it to the computer on the LAN1 in **Subnet 1**.

Figure 159 Using Virtual Interfaces to Avoid Asymmetrical Routes

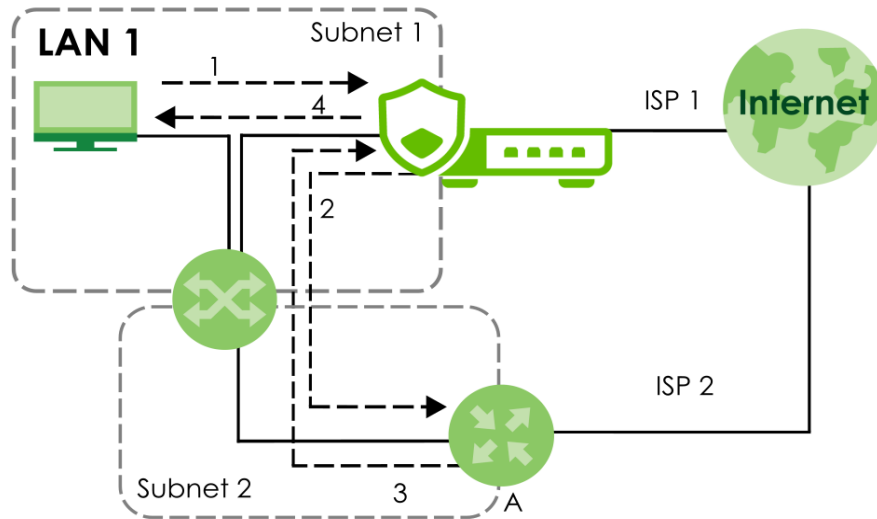

14.3.1 Configuring the Security Policy Control Screen

Click **Security Policy > Policy Control** to open the **Policy Control** screen. Use this screen to enable or disable the security policies and asymmetrical routes, set a maximum number of sessions per host, and display the configured Security Policies. Specify from which zone packets come and to which zone packets travel to display only the policies specific to the selected direction. Note the following.

- Besides configuring the security policies, you also need to configure NAT rules to allow computers on the WAN to access LAN devices.
- The Zyxel Device applies NAT (Destination NAT) settings before applying the security policies. So for example, if you configure a NAT entry that sends WAN traffic to a LAN IP address, when you configure a corresponding security policy to allow the traffic, you need to set the LAN IP address as the destination.
- The ordering of your policies is very important as policies are applied in sequence.

The following screen shows the **Policy Control** summary screen.

Figure 160 Security Policy > Policy Control

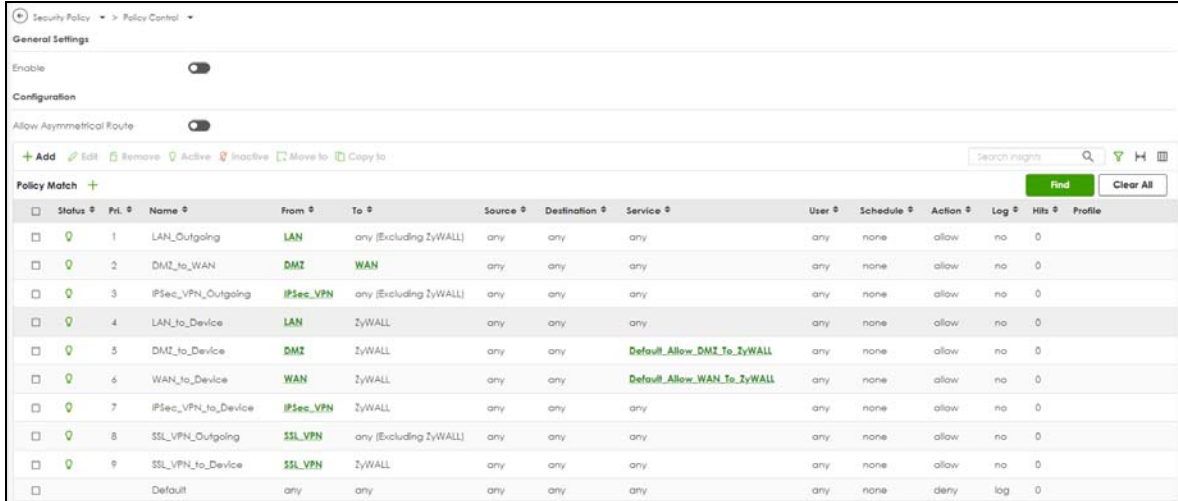



The following table describes the labels in this screen.

Table 113 Security Policy > Policy Control

LABEL	DESCRIPTION
General Settings	Enable or disable the policy control feature on the Zyxel Device.
Allow Asymmetrical Route	<p>If an alternate gateway on the LAN has an IP address in the same subnet as the Zyxel Device's LAN IP address, return traffic may not go through the Zyxel Device. This is called an asymmetrical or "triangle" route. This causes the Zyxel Device to reset the connection, as the connection has not been acknowledged.</p> <p>Select this check box to have the Zyxel Device permit the use of asymmetrical route topology on the network (not reset the connection).</p> <p>Note: Allowing asymmetrical routes may let traffic from the WAN go directly to the LAN without passing through the Zyxel Device. A better solution is to use virtual interfaces to put the Zyxel Device and the backup gateway on separate subnets.</p>
Add	Click this to create a new entry. Select an entry and click Add to create a new entry after the selected entry.
Edit	Double-click an entry or select it and click Edit to open a screen where you can modify the entry's settings.
Remove	To remove an entry, select it and click Remove . The Zyxel Device confirms if you want to remove it before doing so.
Active	To turn on an entry, select it and click Activate .
Inactive	To turn off an entry, select it and click Inactivate .
Move to	<p>To change a policy's position in the numbered list, select the policy and click Move to display a field to type a number for where you want to put that policy and press [ENTER] to move the policy to the number that you typed.</p> <p>The ordering of your policies is important as they are applied in order of their numbering.</p>
Copy to	<p>You can create a new policy by copying an existing one to a new position, and then editing it. Select an existing policy and click Copy to display a field to type a number for where you want to put that policy, then press [ENTER] to copy the policy to the number that you typed.</p> <p>After copying it, edit it to change it from the one copied.</p>
Search	Type an item in the search box, then click this to display all sessions in the table below according to the item you typed.

Table 113 Security Policy > Policy Control (continued)

LABEL	DESCRIPTION
Clear All	Click this to remove all items found in the search.
Filter	<p>Click the Filter icon , click + to expand Policy Match, pick a filter, then click Find to display specific sessions according to the filter selected. You may select multiple filters, but just one of each type, configured one at a time.</p> 
The following read-only fields summarize the policies you have created that apply to traffic traveling in the selected packet direction.	
Status	This icon is lit when the entry is active and dimmed when the entry is inactive.
Priority	This is the position of your Security Policy in the global policy list (including all through-Zyxel Device and to-Zyxel Device policies). The ordering of your policies is important as policies are applied in sequence. Default displays for the default Security Policy behavior that the Zyxel Device performs on traffic that does not match any other Security Policy.
Name	This is the name of the Security policy.
From / To	<p>This is the direction of travel of packets. Select from which zone the packets come and to which zone they go.</p> <p>Security policies are grouped based on the direction of travel of packets to which they apply. For example, from LAN to LAN means packets traveling from a computer or subnet on the LAN to either another computer or subnet on the LAN.</p> <p>From any displays all the security policies for traffic going to the selected To Zone.</p> <p>To any displays all the security policies for traffic coming from the selected From Zone.</p> <p>From any to any displays all of the security policies.</p> <p>To ZyWALL policies are for traffic that is destined for the Zyxel Device and control which computers can manage the Zyxel Device.</p>
Source	This displays the IPv4 source address object, including geographic address and FQDN (group) objects, to which this Security Policy applies.
Destination	This displays the IPv4 destination address object, including geographic address and FQDN (group) objects, to which this Security Policy applies.
Service	This displays the service object to which this security policy applies.
User	This is the user name or user group name to which this security policy applies.
Schedule	This field tells you the schedule object that the policy uses. none means the policy is active at all times if enabled.
Action	This field displays whether the security policy silently discards packets without notification (deny), permits the passage of packets (allow) or drops packets with notification (reject)
Log	Select whether to have the Zyxel Device generate a log (log), log and alert (log alert) or not (no) when the policy is matched to the criteria listed above.
Profile	This field shows you which security service profiles (application patrol, content filter and SSL inspection) apply to the policy control rule. Click the icon to edit the profile directly.

14.3.2 The Policy Control Add/Edit Screen

In the **Policy Control** screen, click the **Edit** or **Add** icon to display the **Policy Control Edit or Add** screen.

Figure 161 Security Policy > Policy Control > Add

The following table describes the labels in this screen.

Table 114 Security Policy > Policy Control > Add

LABEL	DESCRIPTION
Enable	Select this check box to activate the policy control.
Name	Type a name with 1 to 30 single-byte characters to identify the policy, including a-zA-Z0-9. Special characters and spaces are not allowed.
Description	Enter a descriptive name of 1 to 30 single-byte characters for the policy, including spaces and 0-9a-zA-Z!"#\$%()*+,-/;:=?@_&.<>[\]^'{} } are not allowed.
From To	For through-Zyxel Device policies, select the direction of travel of packets to which the policy applies. any means all interfaces. ZyWALL means packets destined for the Zyxel Device itself.
Source	Select an IPv4 address or address group object, including geographic address and FQDN (group) objects, to apply the policy to traffic coming from it. Select any to apply the policy to all traffic coming from IPv4 addresses. Note: If you select an FQDN address with a wildcard in this field, the rule might not be applied because an FQDN with a wildcard cannot cache IP addresses using DNS queries on the Zyxel Device.

Table 114 Security Policy > Policy Control > Add (continued)

LABEL	DESCRIPTION
Destination	Select an IPv4 address or address group, including geographic address and FQDN (group) objects, to apply the policy to traffic going to it. Select any to apply the policy to all traffic going to IPv4 addresses.
Service	Select a service or service group from the drop-down list box.
User	This field is not available when you are configuring a to-Zyxel Device policy. Select a user name or user group to which to apply the policy. The Security Policy is activated only when the specified user logs into the system and the policy will be disabled when the user logs out. Otherwise, select any and there is no need for user logging. Note: If you specified a source IP address (group) instead of any in the field below, the user's IP address should be within the IP address range.
Schedule	Select a schedule that defines when the policy applies. Otherwise, select none and the policy is always effective.
Action	Use the drop-down list box to select what the Security Policy is to do with packets that match this policy. Select deny to silently discard the packets without sending a TCP reset packet or an ICMP destination-unreachable message to the sender. Select reject to discard the packets and send a TCP reset packet or an ICMP destination-unreachable message to the sender. Select allow to permit the passage of the packets.
Log matched traffic	Select whether to have the Zyxel Device generate a log (log), log and alert (log alert) or not (no) when the policy is matched to the criteria listed above.
Profile	Use this section to apply anti-x profiles (created in the Security Services screens) to traffic that matches the criteria above. You must have created a profile first; otherwise none displays. Use Log to generate a log (log), log and alert (log alert) or not (no) for all traffic that matches criteria in the profile.
Application Patrol	Select an Application Patrol profile from the list box; none displays if no profiles have been created in the Security Service > App Patrol screen.
Content Filter	Select a Content Filter profile from the list box; none displays if no profiles have been created in the Security Service > Content Filter screen.
SSL Inspection	Select an SSL Inspection profile from the list box; none displays if no profiles have been created in the Security Service > SSL Inspection screen.
Apply	Click Apply to save your changes back to the Zyxel Device.
Cancel	Click Cancel to return the screen to its last-saved settings.

14.3.3 Example: Allow a Server to Ping the Zyxel Device Without Creating Logs

A server on the LAN pings the Zyxel Device every 15 seconds to check if the Zyxel Device is connected to the Internet. The Zyxel Device creates a log every time the server pings it. You want to allow the server to ping the Zyxel Device without creating so many logs.

This example uses the parameters given below.

Table 115 Address Object Configuration Example

NAME	ADDRESS TYPE	IP ADDRESS
Server	Host	2.2.2.2

Table 116 Security Policy Configuration Example

NAME	FROM	TO	SOURCE	DESTINATION	SERVICE	ACTION	LOG
LAN_to_Device	LAN	ZyWALL	Server	Any	Ping	Allow	No

- 1 Go to **Object > Address > Address** and click **Add**.
- 2 Configure the settings using the parameters given in [Table 115 on page 242](#). Click **Apply** to save your changes.

Configuration









Name

Description

Address Type

IP Address

- 3 Go to **Security Policy > Policy Control** and click **Add**.
- 4 Configure the settings using the parameters given in [Table 116 on page 242](#). Set **Log** to **no** so when the server pings the Zyxel Device, the Zyxel Device will not create logs. Click **Apply** to save your changes.

Configuration	
Enable	<input checked="" type="checkbox"/>
Name	LAN_to_Device
Description	<input type="text"/>
From	LAN 
To	ZyWALL 
Source	Server 
Destination	any 
Service	PING 
User	any 
Schedule	none 
Action	allow 
Log	no 

14.4 DoS Prevention Overview

DoS attacks can flood your Internet connection with invalid packets and connection request, using so much bandwidth and so many resources that Internet access becomes unavailable. The goal of DoS attacks is not to steal information, but to disable a device or network on the Internet.

DoS prevention protects against anomalies based on violations of protocol standards (RFCs – Requests for Comments) and abnormal flows such as port scans. This section introduces DoS prevention profiles and applying a DoS prevention profile to a traffic direction.

Traffic Anomalies

Traffic anomaly policies look for abnormal behavior or events such as port scanning, sweeping or network flooding. They operate at OSI layer-3 and layer-4. Traffic anomaly policies may be updated when you upload new firmware.

Note: First, create a DoS prevention profile in the In the **Security Policy > DoS Prevention > Profile** screen. Then, apply the profile to traffic originating from a specific zone in the **Security Policy > DoS Prevention > DoS Prevention Policy** screen.

14.4.1 The DoS Prevention Policy Screen

Click **Security Policy > DoS Prevention > DoS Prevention Policy** to display the next screen.

Figure 162 Security Policy > DoS Prevention > DoS Prevention Policy

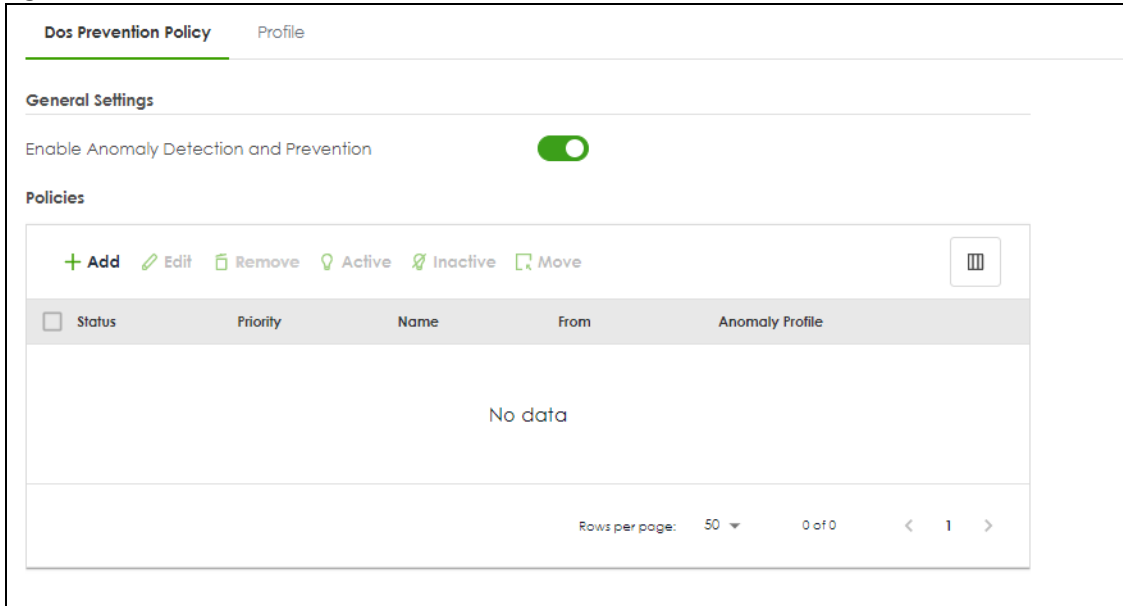

The following table describes the labels in this screen.

Table 117 Security Policy > DoS Prevention > DoS Prevention Policy

LABEL	DESCRIPTION
General Settings	
Enable Anomaly Detection and Prevention	Select this to enable traffic anomaly and protocol anomaly detection and prevention.
Add	Select an entry and click Add to append a new row beneath the one selected. ADP policies are applied in order (Priority) shown in this screen
Edit	Select an entry and click this to be able to modify it.
Remove	Select an entry and click this to delete it.
Active	To turn on an entry, select it and click Activate .
Inactive	To turn off an entry, select it and click Inactivate .
Move	To change an entry's position in the numbered list, select it and click Move to display a field to type a number for where you want to put that entry and press [ENTER] to move the entry to the number that you typed.
Status	The activate (light bulb) icon is lit when the entry is active and dimmed when the entry is inactive.
Priority	This is the rank in the list of anomaly profile policies. The list is applied in order of priority.
Name	This is the name of the anomaly profile policy.

Table 117 Security Policy > DoS Prevention > DoS Prevention Policy

LABEL	DESCRIPTION
From	<p>This is the direction of travel of packets to which an anomaly profile is bound. Traffic direction is defined by the zone the traffic is coming from.</p> <p>Use the From field to specify the zone from which the traffic is coming. Select ZyWALL to specify traffic coming from the Zyxel Device itself.</p> <p>From LAN means packets traveling from a computer on one LAN subnet to a computer on another subnet via the Zyxel Device's LAN1 zone interfaces. The Zyxel Device does not check packets traveling from a LAN computer to another LAN computer on the same subnet.</p> <p>From WAN means packets that come in from the WAN zone and the Zyxel Device routes back out through the WAN zone.</p> <p>Note: Depending on your network topology and traffic load, applying every packet direction to an anomaly profile may affect the Zyxel Device's performance.</p>
Anomaly Profile	<p>An anomaly profile is a set of anomaly policies with configured activation, log and action settings. This field shows which anomaly profile is bound to which traffic direction. Select an ADP profile to apply to the entry's traffic direction. Configure the ADP profiles in the ADP profile screens.</p>

14.4.2 The DoS Prevention Profile Screen

Create new DoS prevention profiles in the **Security Policy > DoS Prevention > Profile** screens.

When creating DoS prevention profiles, you may find that certain policies are triggering too many false positives or false negatives. A false positive is when valid traffic is flagged as an attack. A false negative is when invalid traffic is wrongly allowed to pass through the Zyxel Device. As each network is different, false positives and false negatives are common on initial DoS prevention deployment.

To counter this, you could create a 'monitor profile' that creates logs, but all actions are disabled. Observe the logs over time and try to eliminate the causes of the false alarms. When you're satisfied that they have been reduced to an acceptable level, you could then create an 'in-line profile' whereby you configure appropriate actions to be taken when a packet matches a policy.

DoS prevention profiles consist of traffic anomaly profiles. To create a new profile, click **Add**. Type a new profile name, enable or disable individual policies and then edit the default log options and actions.

Click **Security Policy > DoS Prevention > Profile** to view the following screen.

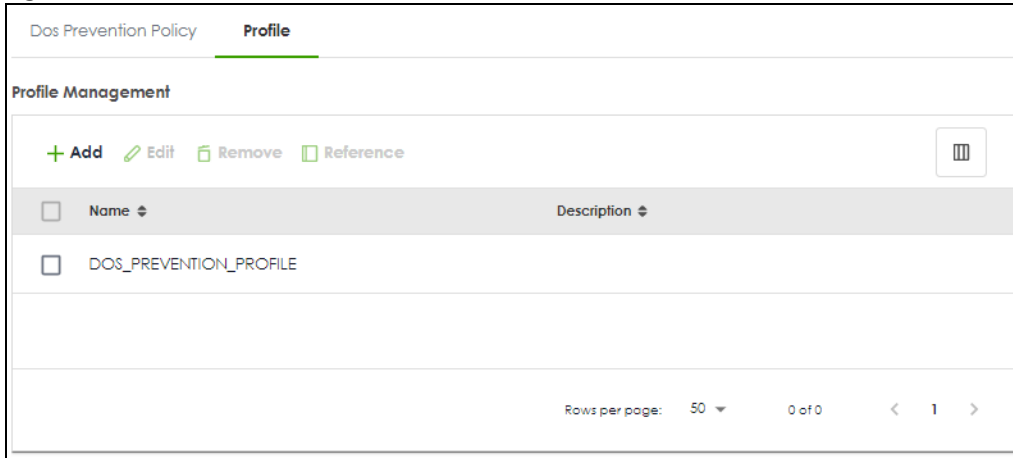
Figure 163 Security Policy > ADP > Profile

The following table describes the labels in this screen.

Table 118 Security Policy > DoS Prevention > Profile

LABEL	DESCRIPTION
Profile Management	Create ADP profiles here and then apply them in the Security Policy > DoS Prevention > DoS Prevention Policy screen.
Add	Click Add to create a new profile.
Edit	Select an entry and click this to be able to modify it.
Remove	Select an entry and click this to delete it.
Reference	Select an entry and click Reference to check which settings use the entry.
Name	This is the name of the profile you created.
Description	This is the description of the profile you created.

14.4.3 The Dos Prevention Profile Add/Edit Screen

DoS prevention looks for abnormal behavior such as scan or flooding attempts. In the **Security Policy > DoS Prevention > Profile** screen, click the **Edit** or **Add** icon to create or edit an existing profile.

Figure 164 Security Policy > DoS Prevention > Profile > Add/Edit

General Settings

*Name

Description

Scan Detection

Sensitivity

*Block Period (1-3600 seconds)

Active
 Inactive
 Log
 Action

☰

<input type="checkbox"/> Status	Name	Log	Action
<input type="checkbox"/>	(portscan) IP Protocol Scan	log	block
<input type="checkbox"/>	(portscan) TCP Portscan	log	block
<input type="checkbox"/>	(portscan) UDP Portscan	log	block
<input type="checkbox"/>	(Sweep) ICMP Sweep	log	block
<input type="checkbox"/>	(Sweep) IP Protocol Sweep	log	block
<input type="checkbox"/>	(Sweep) TCP Sweep	log	block
<input type="checkbox"/>	(sweep) UDP Sweep	log	block

Rows per page: 50 | 1-7 of 7 | < 1 >

Flood Detection

*Block Period (1-3600 seconds)

Edit
 Active
 Inactive
 Log
 Action

☰

<input type="checkbox"/> Status	Name	Log	Action	Threshold
<input type="checkbox"/>	(flood) ICMP Flood	log	block	1000
<input type="checkbox"/>	(flood) IP Flood	log	block	1000
<input type="checkbox"/>	(flood) TCP Flood	log	block	1000
<input type="checkbox"/>	(flood) UDP Flood	log	block	1000

Rows per page: 50 | 1-4 of 4 | < 1 >

Some changes were made

What do you want to do then?

The following table describes the labels in this screen.

Table 119 Security Policy > DoS Prevention > Profile > Add/Edit

LABEL	DESCRIPTION
Name	<p>A name is automatically generated that you can edit. The name must be the same in the DoS Prevention screens for the same DoS prevention profile. You may use 1-31 alphanumeric characters, underscores(_), or dashes (-), but the first character cannot be a number. This value is case-sensitive. These are valid, unique profile names:</p> <ul style="list-style-type: none"> • MyProfile • mYProfile • Mymy12_3-4 <p>These are invalid profile names:</p> <ul style="list-style-type: none"> • 1mYProfile • My Profile • MyProfile? • Whatalongprofilename123456789012
Description	<p>In addition to the name, type additional information to help you identify this DoS prevention profile.</p>
Scan/Flood Detection	<p>Scan detection, such as port scanning, tries to find attacks where an attacker scans device(s) to determine what types of network protocols or services a device supports.</p> <p>Flood detection tries to find attacks that saturate a network with useless data, use up all available bandwidth, and so aim to make communications on the network impossible.</p>
Sensitivity (Scan detection only)	<p>Select a sensitivity level so as to reduce false positives in your network. If you choose low sensitivity, then scan thresholds and sample times are set low, so you will have fewer logs and false positives; however some traffic anomaly attacks may not be detected.</p> <p>If you choose high sensitivity, then scan thresholds and sample times are set high, so most traffic anomaly attacks will be detected; however you will have more logs and false positives.</p>
Block Period	<p>Specify for how many seconds the Zyxel Device blocks all packets from being sent to the victim (destination) of a detected anomaly attack. Flood Detection applies blocking to the destination IP address and Scan Detection applies blocking to the source IP address.</p>
Edit (Flood Detection only)	<p>Select an entry and click this to be able to modify it.</p>
Active	<p>To turn on an entry, select it and click Activate.</p>
Inactive	<p>To turn off an entry, select it and click Inactivate.</p>
Log	<p>To edit an item's log option, select it and use the Log icon. Select whether to have the Zyxel Device generate a log (log), log and alert (log alert) or neither (no) when traffic matches this anomaly policy.</p>
Action	<p>To edit what action the Zyxel Device takes when a packet matches a policy, select the policy and use the Action icon.</p> <p>None: The Zyxel Device takes no action when a packet matches the policy.</p> <p>Block: The Zyxel Device silently drops packets that matches the policy. Neither sender nor receiver are notified.</p>
Status	<p>The activate (light bulb) icon is lit when the entry is active and dimmed when the entry is inactive.</p>
Name	<p>This is the name of the anomaly policy. Click the Name column heading to sort in ascending or descending order according to the protocol anomaly policy name.</p>

Table 119 Security Policy > DoS Prevention > Profile > Add/Edit (continued)

LABEL	DESCRIPTION
Log	These are the log options. To edit this, select an item and use the Log icon.
Action	This is the action the Zyxel Device should take when a packet matches a policy. To edit this, select an item and use the Action icon.
Threshold (pkt/sec)	(Flood detection only.) Select a suitable threshold level (the number of packets per second that match the flood detection criteria) for your network. If you choose a low threshold, most traffic anomaly attacks will be detected, but you may have more logs and false positives. If you choose a high threshold, some traffic anomaly attacks may not be detected, but you will have fewer logs and false positives.
Apply	Click Apply to save your changes back to the Zyxel Device.
Cancel	Click Cancel to return the screen to its last-saved settings.

14.5 IP Spoofing Prevention Overview

Trusted IP/MAC Pair

IP address to MAC address binding helps ensure that only the intended devices get to use privileged IP addresses. The Zyxel Device uses DHCP to assign IP addresses and records the MAC address it assigned to each IP address. The Zyxel Device then checks incoming connection attempts against this list. A user cannot manually assign another IP to his computer and use it to connect to the Zyxel Device.

Suppose you configure access privileges for IP address 192.168.1.27 and use static DHCP to assign it to Tim's computer's MAC address of 12:34:56:78:90:AB. IP/MAC binding drops traffic from any computer trying to use IP address 192.168.1.27 with another MAC address.

Figure 165 Trusted IP/MAC Pair Example

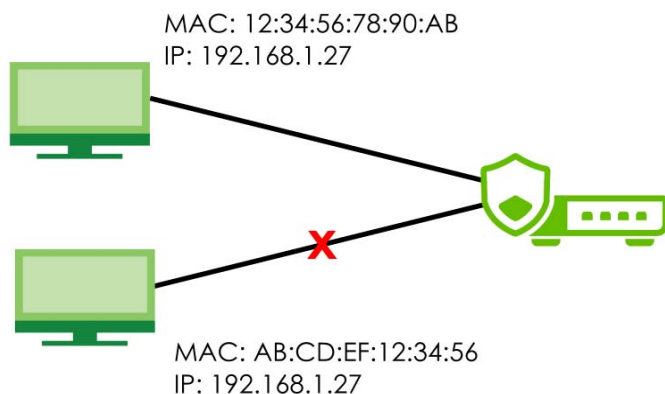

14.5.1 The IP Spoofing Prevention Screen

Click **Security Policy > IP Spoofing Prevention** to display the **IP Spoofing Prevention** screen. Use this screen to configure an interface's IP to MAC address binding settings.

Figure 166 Security Policy > IP Spoofing Prevention

Source IP Spoofing Prevention

Enable

Log

Enable Interface

Trusted IP/MAC Pair ⓘ

Include DHCP Leasing Entries

+ Add

Interface ↕	IP Address ↕	MAC Address ↕	Description ↕
<input type="checkbox"/> ge3	1.1.1.1	11:55:33:ee:33:66	

Trusted IP ⓘ

+ Add

Search insights

Object Name ↕	Description ↕
<input type="checkbox"/> CathyObject	

Some changes were made
What do you want to do then?

The following table describes the labels in this screen.

Table 120 Security Policy > IP Spoofing Prevention

LABEL	DESCRIPTION
Source IP Spoofing Prevention	
Enable	Click to slide the switch to the right to enable IP spoofing prevention.
Log	Select whether to have the Zyxel Device generate a log (log), log and alert (log alert) or neither (no) if a device connected to this interface attempts to use an IP address that is bound to another device's MAC address.
Enable Interface	Select the interface to enforce links between specific IP addresses and specific MAC addresses on this interface. This stops anyone else from manually using a bound IP address on another device connected to this interface. Use this to make use only the intended users get to use specific IP addresses.
Trusted IP/MAC Pair	
Include DHCP Leasing Entries	Enable this to allow traffic from devices that is listed in the current DHCP table. To manage the list of DHCP-assigned IP addresses, click Include DHCP Leasing Entries to go to the Network > DHCP Table screen.
Add	Click this to create a new entry.
Remove	Select an entry and click this to delete it.
Interface	This field displays the name of the interface within the Zyxel Device.
IP Address	This is the IP address that the Zyxel Device assigns to a device with the entry's MAC address.
MAC Address	This is the MAC address of the device to which the Zyxel Device assigns the entry's IP address.
Description	This helps identify the entry.
Trusted IP	
Add	Click this to create a new entry.
Edit	Select an entry and click this to be able to modify it.
Remove	Select an entry and click this to delete it.
Object Name	This is the name of the IP address object to allow traffic.

Table 120 Security Policy > IP Spoofing Prevention (continued)

LABEL	DESCRIPTION
Description	This is the description of the profile you created.
Apply	Click Apply to save your changes back to the Zyxel Device.
Cancel	Click Cancel to return the screen to its last-saved settings.

14.5.2 The Trusted IP Add / Edit Screen

In the **Security Policy > IP Spoofing Prevention** screen, click the **Edit** or **Add** icon to create or edit an existing profile.

Figure 167 Security Policy > IP Spoofing Prevention > Trusted IP Add/Edit

The screenshot shows the 'Trusted IP' configuration screen. It has a title bar 'Trusted IP'. Below it are two input fields: 'Object Name' with the value 'RFC1918_3' and a green edit icon, and 'Description' which is empty. At the bottom right, there is a green notification box with the text 'Some changes were made' and 'What do you want to do then?'. Below the notification are two buttons: 'Cancel' and 'Apply'.

The following table describes the labels in this screen.

Table 121 Security Policy > IP Spoofing Prevention > Trusted IP Add/Edit

LABEL	DESCRIPTION
Trusted IP	
Add	Click this to create a new entry.
Edit	Select an entry and click this to be able to modify it.
Remove	Select an entry and click this to delete it.
Object Name	Select an IP address object to allow traffic from all devices with that IP address.
Description	This helps identify the entry.
Apply	Click Apply to save your changes back to the Zyxel Device.
Cancel	Click Cancel to return the screen to its last-saved settings.

14.6 The Session Control Screen

Click **Security Policy > Session Control** to display the **Session Control** screen. Use this screen to limit the number of concurrent NAT/Security Policy sessions a client can use. You can apply a default limit for all users and individual limits for specific users, addresses, or both. The individual limit takes priority if you apply both.

Figure 168 Security Policy > Session Control



The following table describes the labels in this screen.

Table 122 Security Policy > Session Control

LABEL	DESCRIPTION
General Settings	
Session Control	Click to slide the switch to the right to enable session control.
Default Session per Host	Use this field to set a common limit to the number of concurrent NAT/Security Policy sessions each client computer can have. '0' means unlimited. If only a few clients use peer to peer applications, you can raise this number to improve their performance. With heavy peer to peer application use, lower this number to ensure no single client uses too many of the available NAT sessions. Create rules below to apply other limits for specific users or addresses.
Add	Click this to create a new entry. Select an entry and click Add to create a new entry after the selected entry.
Edit	Double-click an entry or select it and click Edit to open a screen where you can modify the entry's settings.
Remove	To remove an entry, select it and click Remove . The Zyxel Device confirms you want to remove it before doing so.
Activate	To turn on an entry, select it and click Activate .
Inactivate	To turn off an entry, select it and click Inactivate .
Move to	To change a rule's position in the numbered list, select the rule and click Move to to display a field to type a number for where you want to put that rule and press [ENTER] to move the rule to the number that you typed. The ordering of your rules is important as they are applied in order of their priority number.
Status	This icon is lit when the entry is active and dimmed when the entry is inactive.
Priority	This is the priority of a session limit rule. Rules are applied according to priority number.
User	This is the user name or user group name to which this session limit rule applies.
Source IP	This is the IP address of the host to which this session limit rule applies.
Description	This is the information configured to help you identify the rule.
Limit	This is how many concurrent sessions this user or address is allowed to have.
Apply	Click Apply to save your changes back to the Zyxel Device.
Cancel	Click Cancel to return the screen to its last-saved settings.

14.6.1 The Session Control Add/Edit Screen

Click **Security Policy > Session Control** and the **Add** or **Edit** icon to display the **Add or Edit** screen. Use this screen to configure rules that define a session limit for specific users or addresses.

Figure 169 Security Policy > Session Control > Edit

The following table describes the labels in this screen.

Table 123 Security Policy > Session Control > Add/Edit

LABEL	DESCRIPTION
Enable	Click to slide the switch to the right to turn on this session limit rule.
Description	Enter information to help you identify this rule. Use up to 60 printable ASCII characters. Spaces are allowed.
User	<p>Select a user name or user group to which to apply the rule. The rule is activated only when the specified user logs into the system and the rule will be disabled when the user logs out.</p> <p>Otherwise, select any and there is no need for user logging.</p> <div data-bbox="495 1066 1063 1549" style="border: 1px solid black; padding: 5px;"> <p>Select User ✕</p> <p>Search <input type="text" value=""/></p> <p style="text-align: center;">+ Add Object + Add Group</p> <p><input checked="" type="radio"/> any (default)</p> <p>Object (6) ^</p> <ul style="list-style-type: none"> <input type="radio"/> radius-users <input type="radio"/> ldap-users <input type="radio"/> ad-users <input type="radio"/> admin <input type="radio"/> John <input type="radio"/> Cathy <p>Group (0) ^</p> </div> <p>Note: If you specified an IP address (or address group) instead of any in the field below, the user's IP address should be within the IP address range.</p>

Table 123 Security Policy > Session Control > Add/Edit (continued)

LABEL	DESCRIPTION
Address	<p>Select the IPv4/IPv6 source address (range) or address group, including geographic address (group) object, to which this rule applies. Select any to apply the rule to all IPv4 source addresses.</p> <div data-bbox="500 348 1060 898" style="border: 1px solid black; padding: 5px;"> <p>Select Address ✕</p> <p>Search <input type="text"/></p> <p style="text-align: center;">+ Add Object + Add Group</p> <p><input checked="" type="radio"/> any (default)</p> <p><input type="radio"/> user defined</p> <hr/> <p>Object (6) ^</p> <p><input type="radio"/> IP6to4-Relay</p> <p><input type="radio"/> LAN1_SUBNET</p> <p><input type="radio"/> LAN2_SUBNET</p> <p><input type="radio"/> RFC1918_1</p> <p><input type="radio"/> RFC1918_2</p> <p><input type="radio"/> RFC1918_3</p> <hr/> <p>Group (0) ^</p> </div>
Session Limit per Host	<p>Use this field to set a limit to the number of concurrent NAT/Security Policy sessions this rule's users or addresses can have.</p> <p>For this rule's users and addresses, this setting overrides the Default Session per Host setting in the general Security Policy Session Control screen.</p>
Apply	Click Apply to save your customized settings and exit this screen.
Cancel	Click Cancel to exit this screen without saving.

14.7 Security Policy Example Applications

Suppose you decide to block LAN users from using IRC (Internet Relay Chat) through the Internet. To do this, you would configure a LAN to WAN Security Policy that blocks IRC traffic from any source IP address from going to any destination address. You do not need to specify a schedule since you need the Security Policy to always be in effect. The following figure shows the results of this policy.

Figure 170 Blocking All LAN to WAN IRC Traffic Example

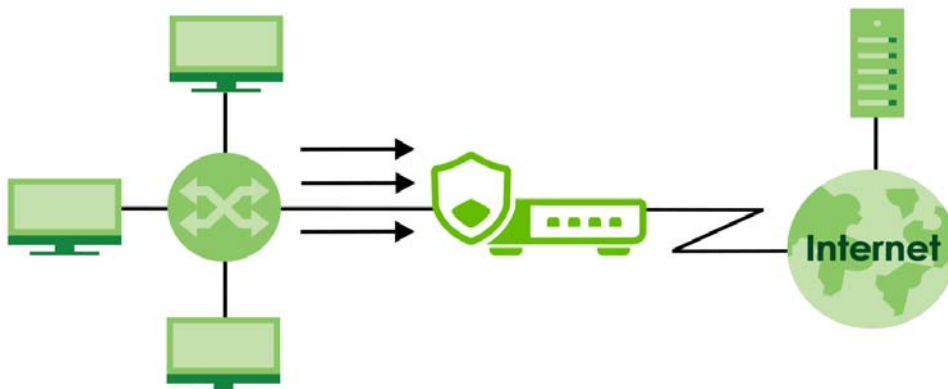

Your Security Policy would have the following settings.

Table 124 Blocking All LAN to WAN IRC Traffic Example

#	USER	SOURCE	DESTINATION	SCHEDULE	SERVICE	ACTION
1	Any	Any	Any	Any	IRC	Deny
2	Any	Any	Any	Any	Any	Allow

- The first row blocks LAN access to the IRC service on the WAN.
- The second row is the Security Policy's default policy that allows all LAN1 to WAN traffic.

The Zyxel Device applies the security policies in order. So for this example, when the Zyxel Device receives traffic from the LAN, it checks it against the first policy. If the traffic matches (if it is IRC traffic) the security policy takes the action in the policy (drop) and stops checking the subsequent security policies. Any traffic that does not match the first security policy will match the second security policy and the Zyxel Device forwards it.

Now suppose you need to let the CEO use IRC. You configure a LAN1 to WAN security policy that allows IRC traffic from the IP address of the CEO's computer. You can also configure a LAN to WAN policy that allows IRC traffic from any computer through which the CEO logs into the Zyxel Device with his/her user name. In order to make sure that the CEO's computer always uses the same IP address, make sure it either:

- Has a static IP address,
or
- You configure a static DHCP entry for it so the Zyxel Device always assigns it the same IP address.

Now you configure a LAN1 to WAN security policy that allows IRC traffic from the IP address of the CEO's computer (172.16.1.7 for example) to go to any destination address. You do not need to specify a schedule since you want the security policy to always be in effect. The following figure shows the results of your two custom policies.

Figure 171 Limited LAN to WAN IRC Traffic Example

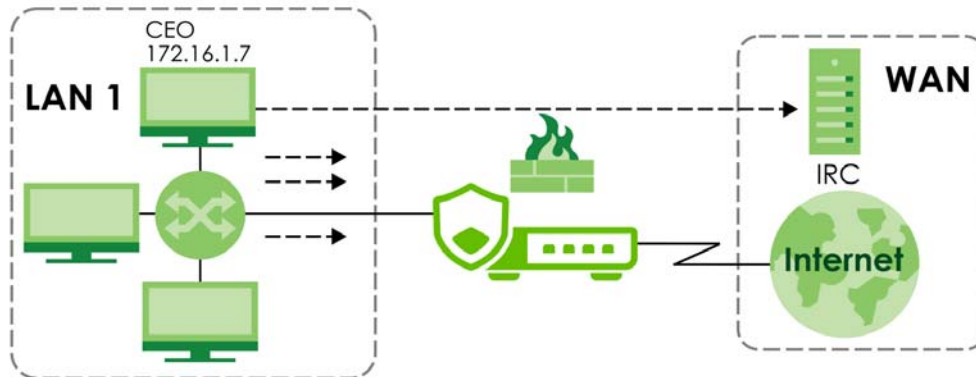

Your security policy would have the following configuration.

Table 125 Limited LAN1 to WAN IRC Traffic Example 1

#	USER	SOURCE	DESTINATION	SCHEDULE	SERVICE	ACTION
1	Any	172.16.1.7	Any	Any	IRC	Allow

Table 125 Limited LAN1 to WAN IRC Traffic Example 1 (continued)

#	USER	SOURCE	DESTINATION	SCHEDULE	SERVICE	ACTION
2	Any	Any	Any	Any	IRC	Deny
3	Any	Any	Any	Any	Any	Allow

- The first row allows the LAN1 computer at IP address 172.16.1.7 to access the IRC service on the WAN.
- The second row blocks LAN1 access to the IRC service on the WAN.
- The third row is the default policy of allowing all traffic from the LAN1 to go to the WAN.

Alternatively, you configure a LAN1 to WAN policy with the CEO's user name (say CEO) to allow IRC traffic from any source IP address to go to any destination address.

Your Security Policy would have the following settings.

Table 126 Limited LAN1 to WAN IRC Traffic Example 2

#	USER	SOURCE	DESTINATION	SCHEDULE	SERVICE	ACTION
1	CEO	Any	Any	Any	IRC	Allow
2	Any	Any	Any	Any	IRC	Deny
3	Any	Any	Any	Any	Any	Allow

- The first row allows any LAN1 computer to access the IRC service on the WAN by logging into the Zyxel Device with the CEO's user name.
- The second row blocks LAN1 access to the IRC service on the WAN.
- The third row is the default policy of allowing allows all traffic from the LAN1 to go to the WAN.

The policy for the CEO must come before the policy that blocks all LAN1 to WAN IRC traffic. If the policy that blocks all LAN1 to WAN IRC traffic came first, the CEO's IRC traffic would match that policy and the Zyxel Device would drop it and not check any other security policies.

CHAPTER 15

Object

15.1 Address/Geo IP Overview

Address objects can represent a single IP address or a range of IP addresses. Address groups are composed of address objects and other address groups.

- The **Address** screen ([Section 15.1.2 on page 257](#)) provides a summary of all addresses in the Zyxel Device. Use the **Address Add/Edit** screen to create a new address or edit an existing one.
- Use the **Address Group** summary screen ([Section 15.1.3 on page 260](#)) and the **Address Group Add/Edit** screen, to maintain address groups in the Zyxel Device.
- Use the **Geo IP** screen ([Section 15.1.4 on page 263](#)) to update the database of country-to-IP address mappings and to manually configure country-to-IP address mappings.

15.1.1 What You Need To Know

Address objects and address groups are used in policy routes, security policies, application patrol, content filtering, and VPN connection policies. For example, addresses are used to specify where content restrictions apply in content filtering. Please see the respective sections for more information about how address objects and address groups are used in each one.

Address groups are composed of address objects and address groups. The sequence of members in the address group is not important.

15.1.2 Address Summary Screen

The address screens are used to create, maintain, and remove addresses.

The **Address** screen provides a summary of all addresses in the Zyxel Device. To access this screen, click **Object > Address > Address**. Click a column's heading cell to sort the table entries by that column's criteria. Click the heading cell again to reverse the sort order.

Figure 172 Object > Address > Address

Name ↑	Type	Address	Reference
<input type="checkbox"/> IP6to4-Relay	HOST	192.88.99.1	0
<input type="checkbox"/> LAN1_SUBNET	INTERFACE SUBNET	ge3	0
<input type="checkbox"/> LAN2_SUBNET	INTERFACE SUBNET	ge4	0
<input type="checkbox"/> RFC1918_1	SUBNET	10.0.0.0/8	0
<input type="checkbox"/> RFC1918_2	SUBNET	172.16.0.0/12	0
<input type="checkbox"/> RFC1918_3	SUBNET	192.168.0.0/16	0

The following table describes the labels in this screen. See [Section 15.1.2.1 on page 258](#) for more information as well.

Table 127 Object > Address > Address

LABEL	DESCRIPTION
IPv4 Address Configuration	
Add	Click this to create a new entry.
Edit	Double-click an entry or select it and click Edit to be able to modify the entry's settings.
Remove	To remove an entry, select it and click Remove . The Zyxel Device confirms you want to remove it before doing so.
Reference	Select an entry and click Reference to check which settings use the entry.
Name	This field displays the configured name of each address object.
Type	This field displays the type of each address object. " INTERFACE " means the object uses the settings of one of the Zyxel Device's interfaces.
Address	This field displays the IPv4 addresses represented by each address object. If the object's settings are based on one of the Zyxel Device's interfaces, the name of the interface displays first followed by the object's current address settings.
Reference	This displays the number of times an object reference is used in a profile.

15.1.2.1 IPv4 Address Add/Edit Screen

The **Object > Address > Address > Add/Edit** screen allows you to create a new address or edit an existing one. To access this screen, go to the **Address** screen (see [Section 15.1.2 on page 257](#)), and click either the **Add** icon or an **Edit** icon in the **IPv4 Address Configuration** section.

Figure 173 Object > Address > Address > Add/Edit

The screenshot shows a configuration window titled 'Configuration'. It contains the following fields:

- *Name:** Config1
- Description:** (empty text box)
- Address Type:** HOST (dropdown menu)
- *IP Address:** 0.0.0.0

At the bottom right, there is a green notification box with the text: "Some changes were made. What do you want to do then?". Below this text are two buttons: "Cancel" and "Apply".

The following table describes the labels in this screen.

Table 128 Object > Address > Address > Add/Edit

LABEL	DESCRIPTION
Name	Type the name used to refer to the address. You may use 2-30 single-byte characters, including 0-9a-zA-Z, underscores(_), or dashes (-), but the first character cannot be a number. This value is case-sensitive.
Description	Enter the description associated with the zone, if any. You can use 1 to 30 single-byte characters, including 0-9a-zA-Z. Special characters are not allowed
Address Type	<p>Select the type of address you want to create.</p> <ul style="list-style-type: none"> HOST - the object uses an IP Address to define a host address. RANGE - the object uses a range address defined by a Starting IP Address and an Ending IP Address. SUBNET - the object uses a network address defined by a Network IP address and Netmask subnet mask. INTERFACE IP - the object uses the IP address of one of the Zyxel Device's interfaces. INTERFACE SUBNET - the object uses the subnet mask of one of the Zyxel Device's interfaces. INTERFACE GATEWAY - the object uses the gateway IP address of one of the Zyxel Device's interfaces. GEOGRAPHY - the object uses the IP addresses of a country to represent a country. FQDN - the object uses the Fully Qualified Domain Name (FQDN) to represent a website. An FQDN consists of a host and domain name. For example, 'www.zyxel.com.tw' is a fully qualified domain name, where 'www' is the host, 'zyxel' is the third-level domain, 'com' is the second-level domain, and "tw" is the top level domain. <p>Note: The Zyxel Device automatically updates address objects that are based on an interface's IP address, subnet, or gateway if the interface's IP address settings change. For example, if you change 1's IP address, the Zyxel Device automatically updates the corresponding interface-based, LAN subnet address object.</p>
IP Address	This field is only available if the Address Type is HOST . This field cannot be blank. Enter the IP address that this address object represents.
Starting IP Address	This field is only available if the Address Type is RANGE . This field cannot be blank. Enter the beginning of the range of IP addresses that this address object represents.

Table 128 Object > Address > Address > Add/Edit

LABEL	DESCRIPTION
Ending IP Address	This field is only available if the Address Type is RANGE . This field cannot be blank. Enter the end of the range of IP address that this address object represents.
Network	This field is only available if the Address Type is SUBNET , in which case this field cannot be blank. Enter the IP address of the network that this address object represents.
Netmask	This field is only available if the Address Type is SUBNET , in which case this field cannot be blank. Enter the subnet mask of the network that this address object represents. Use dotted decimal format.
Interface	If you selected INTERFACE IP , INTERFACE SUBNET , or INTERFACE GATEWAY as the Address Type , use this field to select the interface of the network that this address object represents.
Region	If you selected GEOGRAPHY as the Address Type , use this field to select a country or continent. A GEOGRAPHY object uses the data from the country-to-IP/continent-to-IP address database. Go to the Object > Address > Geo IP screen to configure the custom country-to-IP/continent-to-IP address mappings for a GEOGRAPHY object.
FQDN	This field is only available if the Address Type is FQDN , in which case this field cannot be blank. Enter the FQDN of the website that this address object represents. You can enter a wildcard in the first position. For example, <code>*.zyxel.com</code> . Click Test to check if the FQDN you entered is valid and to view the result of the DNS query. The Test button is disabled if you enter a FQDN with a wildcard.
Expire cache by TTL	Enable this to automatically clear the cache when the duration for storing a DNS record in the DNS cache has expired. Disable this if you want to keep the DNS record in the DNS cache after it has expired.
IPv4 Cache List You must first configure IPv4 FQDN objects in this screen.	
IP Address	This field displays the mapping of the FQDN to an IP address. This is the IP address of a host.
TTL	Time to Live (TTL) shows the number of seconds remaining before the DNS record expires. If the Expire cache by TTL option is disabled, the DNS record will not be cleared from the IPv4 Cache List when the TTL expires. The IPv4 Cache List will be updated if the following conditions are met. <ul style="list-style-type: none"> • The FQDN does not include a wildcard, and • Two minutes after all the TTL (Time To Live) values have expired.
Apply	Click Apply to save your customized settings and exit this screen.
Cancel	Click Cancel to return the screen to its last-saved settings.

15.1.3 Address Group Summary Screen

The **Address Group** screen provides a summary of all address groups. To access this screen, click **Object > Address > Address Group**. Click a column's heading cell to sort the table entries by that column's criteria. Click the heading cell again to reverse the sort order.

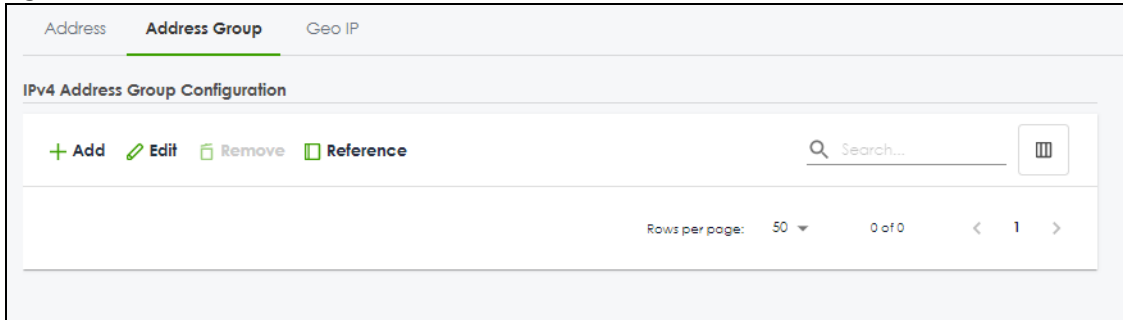
Figure 174 Object > Address > Address Group

The following table describes the labels in this screen. See [Section 15.1.3.1 on page 261](#) for more information as well.

Table 129 Object > Address > Address Group

LABEL	DESCRIPTION
IPv4 Address Group Configuration	
Add	Click this to create a new entry.
Edit	Select an entry and click Edit to be able to modify the entry's settings.
Remove	To remove an entry, select it and click Remove . The Zyxel Device confirms you want to remove it before doing so.
Reference	Select an entry and click Reference to check which settings use the entry.
Name	This field displays the name of each address group.
Description	This field displays the description of each address group, if any.
Reference	This displays the number of times an object reference is used in a profile.

15.1.3.1 Address Group Add/Edit Screen

The **Address Group Add/Edit** screen allows you to create a new address group or edit an existing one. To access this screen, go to the **Address Group** screen (see [Section 15.1.3 on page 260](#)), and click either the **Add** icon or an **Edit** icon in the **IPv4 Address Group Configuration** section.

Figure 175 IPv4 Address Group > Add

The following table describes the labels in this screen.

Table 130 IPv4 Address Group > Add

LABEL	DESCRIPTION
Name	Enter a name for the address group. You may use 2-30 single-byte characters, including 0-9a-zA-Z, underscores(_), or dashes (-), but the first character cannot be a number. This value is case-sensitive.
Description	You can use 1 to 30 single-byte characters, including 0-9a-zA-Z!"#\$%&'()*+,-./:;=?@_&.<>[\]{} ^' are not allowed.
Add Object	Click this button to create an address object. See Section 15.1.2.1 on page 258 for more information on configuring an address object.
Search	Type an item in the search box, then click this to display all address objects in the table below according to the item you typed.
Select All	Select this to select all address objects and address groups in the table.
Member List	The list on the left displays the names of the address and address group objects that have been added to the address group. The order of members is not important. Select items from this list that you want to be members and move them to the list on the right. Move any members you do not want included to the list on the left. Note: Only objects of the same address type can be added to a address group.
Apply	Click Apply to save your customized settings and exit this screen.
Cancel	Click Cancel to return the screen to its last-saved settings.

15.1.4 Geo IP Summary Screen

Use this screen to update the database of country-to-IP and continent-to-IP address mappings and manually configure custom country-to-IP and continent-to-IP address mappings in geographic address objects. You can then use geographic address objects in security policies to forward or deny traffic to whole countries or regions.

Click a column's heading cell to sort the table entries by that column's criteria. Click the heading cell again to reverse the sort order.

Figure 176 Object > Address > Geo IP

The screenshot shows the 'Geo IP' configuration page. At the top, there are navigation tabs for 'Address', 'Address Group', and 'Geo IP'. Below the tabs, the 'Country Database Update' section shows the latest and current versions (both 20220426) and an 'Update Now' button. An 'Auto Update' toggle is currently off. The 'Custom IPv4 to Geography Rules' section has an input field with '1.1.1.1' and a green 'IPv4 to Geography' button, with 'Australia' listed as the mapped location. Below this is a table with columns for Name, Geolocation, Type, and IPv4 Address, which is currently empty with a 'No data' message. The 'Region vs. Continent' section at the bottom contains a table with columns for Region and Continent, listing Algeria, Angola, Benin, and Botswana, all mapped to Africa.

Region	Continent
Algeria	Africa
Angola	Africa
Benin	Africa
Botswana	Africa

Figure 177 Object > Address > Geo IP > Region vs. Continent

Region	Continent
Afghanistan	Asia
Aland Islands	Europe
Albania	Europe
Algeria	Africa
American Samoa	Oceania
Andorra	Europe
Angola	Africa
Anguilla	North America
Antarctica	Antarctica
Antigua and Barbuda	North America
Argentina	South America
Armenia	Asia
Aruba	North America
Australia	Oceania
Austria	Europe
Azerbaijan	Asia
Bahamas	North America
Bahrain	Asia
Bangladesh	Asia
Barbados	North America
Belarus	Europe
Belgium	Europe
Belize	North America
Benin	Africa
Bermuda	North America
Bhutan	Asia
Bolivia	South America
Bonaire, Sint Eustatius, and Saba	North America
Bosnia and Herzegovina	Europe
Botswana	Africa
Bouvet Island	Antarctica
Brazil	South America
British Indian Ocean Territory	Asia
Brunei	Asia
Bulgaria	Europe
Burkina Faso	Africa
Burundi	Africa
Cambodia	Asia
Cameroon	Africa
Canada	North America
Cape Verde	Africa
Cayman Islands	North America
Central African Republic	Africa
Chad	Africa
Chile	South America
China	Asia
Christmas Island	Asia
Cocos (Keeling) Islands	Asia
Colombia	South America

The following table describes the labels in this screen.

Table 131 Object > Address/Geo IP > Geo IP

LABEL	DESCRIPTION
Country Database Update	
Latest Version	This is the latest country-to-IP address database version.
Current Version	This is the country-to-IP address database version currently on the Zyxel Device.
Update Now	Click this to check for the latest country-to-IP address database version. The latest version is downloaded to the Zyxel Device and replaces the current version if it is newer. There are logs to show the update status.
Auto Update	If you want the Zyxel Device to check weekly for the latest country-to-IP address database version, select the checkbox, choose a day and time each week and then click Apply .
Custom IPv4 to Geography Rules	Enter an IP address, then click the IPv4 to Geography button to query which country this IP address belongs to.
Add	Click this to create a new entry.
Edit	Select an entry and click Edit to be able to modify the entry's settings.
Remove	To remove an entry, select it and click Remove . The Zyxel Device confirms you want to remove it before doing so.
Name	This field displays the name of the entry.
Geolocation	This field displays the name of the country or region that is associated with this IP address.
Type	This field displays whether this address object is HOST , RANGE or SUBNET .
IPv4 Address	This field displays the IPv4/IPv6 addresses represented by the type of address object.
Region vs. Continent	
Region vs. Continent	Enter a country or continent name in the Search field to query which continent this country belongs to or which countries belong to the continent.

15.1.4.1 Add Custom IPv4 Address to Geography Screen

This screen allows you to create a new geography-to-IP address mapping. To access this screen, go to the **Geo IP** screen (see [Section 15.1.4 on page 263](#)), and click the **Add** icon in the **Custom IPv4 to Geography Rules** section.

Figure 178 Geo IP > Add

Object > Address > Geo IP

Configuration

Name: Senegal

Region vs. Continent: Region Continent

Geolocation: Africa

Address Type: HOST

IP Address: 0.0.0.0

Some changes were made
What do you want to do then?
Cancel Apply

The following table describes the labels in this screen.

Table 132 Geo IP > Add

LABEL	DESCRIPTION
Name	Enter a name for the address group. You may use 2-30 single-byte characters, including 0-9a-zA-Z, underscores(_), or dashes (-), but the first character cannot be a number. This value is case-sensitive.
Region	Select the country or continent that maps to this IP address.
Address Type	Select the type of address you want to create. Choices are: HOST , RANGE , CIDR .
IP Address	This field is only available if the Address Type is HOST . This field cannot be blank. Enter the IP address that this address object represents.
IP Starting Address	This field is only available if the Address Type is RANGE . This field cannot be blank. Enter the beginning of the range of IP addresses that this address object represents.
IP Ending Address	This field is only available if the Address Type is RANGE . This field cannot be blank. Enter the end of the range of IP address that this address object represents.
Network / Netmask	These fields are only available if the IPv4 Address Type is SUBNET . They cannot be blank. Enter the network IP and subnet mask that defines the IPv4 subnet.
Apply	Click Apply to save your customized settings and exit this screen.
Cancel	Click Cancel to return the screen to its last-saved settings.

15.2 Service Overview

Use service objects to define TCP applications, UDP applications, and ICMP messages. You can also create service groups to refer to multiple service objects in other features.

- Use the **Service** screens ([Section 15.2.2 on page 268](#)) to view and configure the Zyxel Device's list of services and their definitions.
- Use the **Service Group** screens ([Section 15.2.2 on page 268](#)) to view and configure the Zyxel Device's list of service groups.

15.2.1 What You Need to Know

IP Protocols

IP protocols are based on the eight-bit protocol field in the IP header. This field represents the next-level protocol that is sent in this packet. This section discusses three of the most common IP protocols.

Computers use Transmission Control Protocol (TCP, IP protocol 6) and User Datagram Protocol (UDP, IP protocol 17) to exchange data with each other. TCP guarantees reliable delivery but is slower and more complex. Some uses are FTP, HTTP, SMTP, and TELNET. UDP is simpler and faster but is less reliable. Some uses are DHCP, DNS, RIP, and SNMP.

TCP creates connections between computers to exchange data. Once the connection is established, the computers exchange data. If data arrives out of sequence or is missing, TCP puts it in sequence or waits for the data to be re-transmitted. Then, the connection is terminated.

In contrast, computers use UDP to send short messages to each other. There is no guarantee that the messages arrive in sequence or that the messages arrive at all.

Both TCP and UDP use ports to identify the source and destination. Each port is a 16-bit number. Some port numbers have been standardized and are used by low-level system processes; many others have no particular meaning.

Unlike TCP and UDP, Internet Control Message Protocol (ICMP, IP protocol 1) is mainly used to send error messages or to investigate problems. For example, ICMP is used to send the response if a computer cannot be reached. Another use is ping. ICMP does not guarantee delivery, but networks often treat ICMP messages differently, sometimes looking at the message itself to decide where to send it.

Service Objects and Service Groups

Use service objects to define IP protocols.

- TCP applications
- UDP applications
- ICMP messages
- user-defined services (for other types of IP protocols)

These objects are used in policy routes and security policies.

Use service groups when you want to create the same rule for several services, instead of creating separate rules for each service. Service groups may consist of services and other service groups. The sequence of members in the service group is not important.

Reference

Use **Reference** in a screen to view which configuration settings reference to the object.

For example, go to **Object > Service**. select an entry, then click **Reference** to open the **References** screen. The **References** screen displays which settings are using the selected entry.

Figure 179 Reference

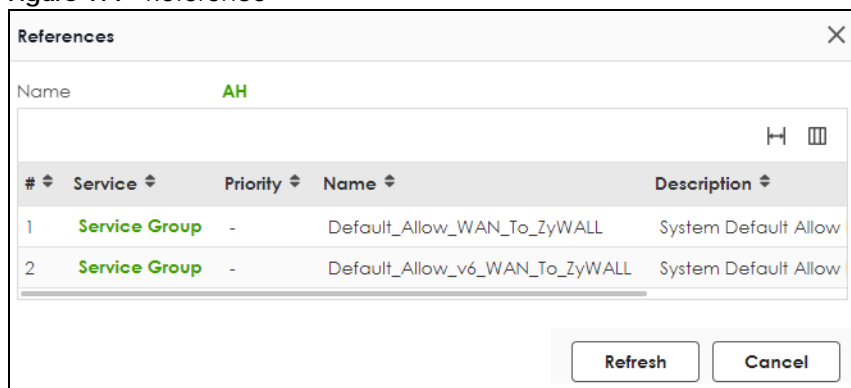

This table describes the fields in this screen.

Table 133 References

LABEL	DESCRIPTION
Name	This identifies the object for which the configuration settings that use it are displayed. Click the object's name to display the object's configuration screen in the main window.
#	This field is a sequential value, and it is not associated with any entry.

Table 133 References

LABEL	DESCRIPTION
Service	This is the type of setting that references the selected object. Click a service's name to display the service's configuration screen in the main window.
Priority	If it is applicable, this field displays the referencing configuration item's position in its list; otherwise - displays.
Name	This field identifies the configuration item that references the object.
Description	If the referencing configuration has a description configured, it displays here.
Refresh	Click this to update the information in this screen.
Cancel	Click this to close the screen.

15.2.2 The Service Summary Screen

The **Service** summary screen provides a summary of all services and their definitions. In addition, this screen allows you to add, edit, and remove services.

To access this screen, log in to the Web Configurator, and click **Object > Service > Service**. Click a column's heading cell to sort the table entries by that column's criteria. Click the heading cell again to reverse the sort order.

Figure 180 Object > Service > Service

Service		Service Group	
Configuration			
+ Add ✎ Edit 🗑 Remove 🔍 Reference			
<input type="text" value="Search..."/>			
Name ↑	Content	Reference	
<input type="checkbox"/> AH	Protocol=51	2	
<input type="checkbox"/> AIM	TCP=5190	0	
<input type="checkbox"/> AUTH	TCP=113	0	
<input type="checkbox"/> Any_TCP	TCP=1-65535	0	
<input type="checkbox"/> Any_UDP	UDP=1-65535	0	
<input type="checkbox"/> BGP	TCP=179	0	
<input type="checkbox"/> BONJOUR	UDP=5353	0	
<input type="checkbox"/> BOOTP_CLIENT	UDP=68	0	
<input type="checkbox"/> BOOTP_SERVER	UDP=67	0	
<input type="checkbox"/> CAPWAP-CONTROL	UDP=5246	0	
<input type="checkbox"/> CAPWAP-DATA	UDP=5247	0	
<input type="checkbox"/> CU_SEEME_TCP1	TCP=7648	1	
<input type="checkbox"/> CU_SEEME_TCP2	TCP=24032	1	
<input type="checkbox"/> CU_SEEME_UDP1	UDP=7648	1	
<input type="checkbox"/> CU_SEEME_UDP2	UDP=24032	1	
<input type="checkbox"/> DHCPv6_CLIENT	UDP=546	1	

The following table describes the labels in this screen.

Table 134 Object > Service > Service

LABEL	DESCRIPTION
Add	Click this to create a new entry.
Edit	Double-click an entry or select it and click Edit to be able to modify the entry's settings.
Remove	To remove an entry, select it and click Remove . The Zyxel Device confirms you want to remove it before doing so.
Reference	Select an entry and click Reference to check which settings use the entry.
Name	This field displays the name of each service.
Content	This field displays a description of each service.
Reference	This displays the number of times an object reference is used in a profile.

15.2.2.1 The Service Add/Edit Screen

The **Service Add/Edit** screen allows you to create a new service or edit an existing one. To access this screen, go to the **Service** screen (see [Section 15.2.2 on page 268](#)), and click either the **Add** icon or an **Edit** icon.

Figure 181 Object > Service > Service > Add/Edit

The screenshot shows a configuration form with the following fields and error messages:

- Name:** A text input field with a red border and an error message: "The value in this field is invalid. It must begin with a letter and cannot exceed 30 characters. The valid characters are [0-9][a-z][^~!@#%&*+,-./].".
- Description:** A text input field.
- IP Protocol:** A dropdown menu currently set to "TCP".
- *Starting Port:** A text input field with a red border and an error message: "The minimum value for this field is 1.". A range indicator "[1..65535]" is shown to the right.
- Ending Port:** A text input field with a range indicator "[1..65535]" to its right.

At the bottom right, a green notification box contains the text: "Some changes were made. What do you want to do then?" with two buttons: "Cancel" and "Apply".

The following table describes the labels in this screen.

Table 135 Object > Service > Service > Add/Edit

LABEL	DESCRIPTION
Name	Type the name used to refer to the service. You may use 1-30 single-byte characters, including 0-9a-zA-Z!"#\$%&'()*+,-./:;=?@_ , but the first character cannot be a number. &.<>[\]{ ^ are not allowed. This value is case-sensitive.
Description	Type the description used to refer to the service. You may use 1-30 single-byte characters, including 0-9a-zA-Z!"#\$%&'()*+,-./:;=?@_ , but the first character cannot be a number. &.<>[\]{ ^ are not allowed.
IP Protocol	Select the protocol the service uses. Choices are: TCP , UDP , ICMP , ICMPv6 , and User Defined .
Starting Port	This field appears if the IP Protocol is TCP or UDP . Specify the port number(s) used by this service.
Ending Port	If you fill in one of these fields, the service uses that port. If you fill in both fields, the service uses the range of ports.
ICMP Type	This field appears if the IP Protocol is ICMP or ICMPv6 . Select the ICMP message used by this service. This field displays the message text, not the message number.
IP Protocol Number	This field appears if the IP Protocol is User Defined . Enter the number of the next-level protocol (IP protocol). Allowed values are 1 - 255.
Apply	Click Apply to save your customized settings and exit this screen.
Cancel	Click Cancel to return the screen to its last-saved settings.

15.2.3 The Service Group Summary Screen

The **Service Group** summary screen provides a summary of all service groups. In addition, this screen allows you to add, edit, and remove service groups.

Note: If you want to access the Zyxel Device using **HTTP**, **HTTPS**, and/or **SSH**, you must add them in the **Object > Service > Service Group > Default_Allow_WAN_To_ZyWALL** service group, which is used in the **WAN_to_Device** security policy.

To access this screen, click **Object > Service > Service Group**.

Figure 182 Object > Service > Service Group

Service		Service Group	
Family	Name ↑	Description	Reference
<input type="checkbox"/>	CU-SEEME		0
<input type="checkbox"/>	DHCPv6		0
<input type="checkbox"/>	DNS		2
<input type="checkbox"/>	Default_Allow_DMZ_To_ZyWALL	System Default Allow From DMZ ...	0
<input type="checkbox"/>	Default_Allow_ICMPv6_Group	Default Allow icmpv6 to ZyWALL	1
<input type="checkbox"/>	Default_Allow_WAN_To_ZyWALL	System Default Allow From WAN ...	0
<input type="checkbox"/>	Default_Allow_v6_DMZ_To_ZyWALL	System Default Allow IPv6 From ...	0
<input type="checkbox"/>	Default_Allow_v6_WAN_To_ZyW...	System Default Allow IPv6 Form ...	0
<input type="checkbox"/>	Default_Allow_v6_any_to_ZyWALL	System Default Allow IPv6 From ...	0
<input type="checkbox"/>	IRC		0
<input type="checkbox"/>	NetBIOS		2
<input type="checkbox"/>	ROADRUNNER		0
<input type="checkbox"/>	RTSP		0
<input type="checkbox"/>	SNMP		0
<input type="checkbox"/>	SNMP-TRAPS		0
<input type="checkbox"/>	SSH		0

Rows per page: 50 ▼ 1-16 of 16 < 1 >

The following table describes the labels in this screen. See [Section 15.2.3.1 on page 272](#) for more information as well.

Table 136 Object > Service > Service Group

LABEL	DESCRIPTION
Add	Click this to create a new entry.
Edit	Double-click an entry or select it and click Edit to be able to modify the entry's settings.
Remove	To remove an entry, select it and click Remove . The Zyxel Device confirms you want to remove it before doing so.
Reference	Select an entry and click Reference to check which settings use the entry.
Name	This field displays the name of each service group. By default, the Zyxel Device uses services starting with "Default_Allow_" in the security policies to allow certain services to connect to the Zyxel Device.
Description	This field displays the description of each service group, if any.
Reference	This displays the number of times an object reference is used in a profile.

15.2.3.1 The Service Group Add/Edit Screen

The **Service Group Add/Edit** screen allows you to create a new service group or edit an existing one. To access this screen, go to the **Service Group** screen (see [Section 15.2.3 on page 271](#)), and click either the **Add** icon or an **Edit** icon.

Figure 183 Object > Service > Service Group > Add/Edit

Object > Service > Service Group

Configuration

Name

! It cannot exceed 30 characters. The valid characters are [0-9][a-z][A-Z][-,].

Description

Member List

+ Add Object

Available

Filter items...

Select All

Object

- AH
- AUTH
- Any-TCP
- Any-UDP
- BGP
- BONJOUR
- CAPWAP-CONTROL
- CAPWAP-DATA
- DHCP-CLIENT

Member

Filter items...

Select All

Object

Group

Some changes were made
What do you want to do then?

The following table describes the labels in this screen.

Table 137 Object > Service > Service Group > Edit

LABEL	DESCRIPTION
Name	Type the name used to refer to the service group. You may use 1-30 single-byte characters, including 0-9a-zA-Z!"#\$%()*+,-/;=?@_ , but the first character cannot be a number. &.<>[\]{}^' are not allowed. This value is case-sensitive.
Description	Type the description used to refer to the service group. You may use 1-30 single-byte characters, including 0-9a-zA-Z!"#\$%()*+,-/;=?@_ , but the first character cannot be a number. &.<>[\]{}^' are not allowed.
Add Object	Click this button to create an address object. See Section 15.1.2.1 on page 258 for more information on configuring an address object.
Search	Type an item in the search box, then click this to display all address objects in the table below according to the item you typed.
Select All	Select this to select all address objects and address groups in the table.
Member List	This list displays the names of the service and service group objects that have been added to the service group. The order of members is not important. Select items from the list on the left that you want to be members and move them to the list on the right. Move any members you do not want included to the list on the left.
Apply	Click Apply to save your customized settings and exit this screen.
Cancel	Click Cancel to return the screen to its last-saved settings.

15.3 Zone Overview

Set up zones to configure network security and network policies in the Zyxel Device. A zone is a group of interfaces and/or VPN tunnels. The Zyxel Device uses zones instead of interfaces in many security and policy settings, such as Security Policy rules, Security Service, and remote management.

Zones cannot overlap. Each Ethernet interface, VLAN interface, bridge interface, PPPoE/PPTP interface and VPN tunnel can be assigned to at most one zone. Virtual interfaces are automatically assigned to the same zone as the interface on which they run.

Figure 184 Example: Zones

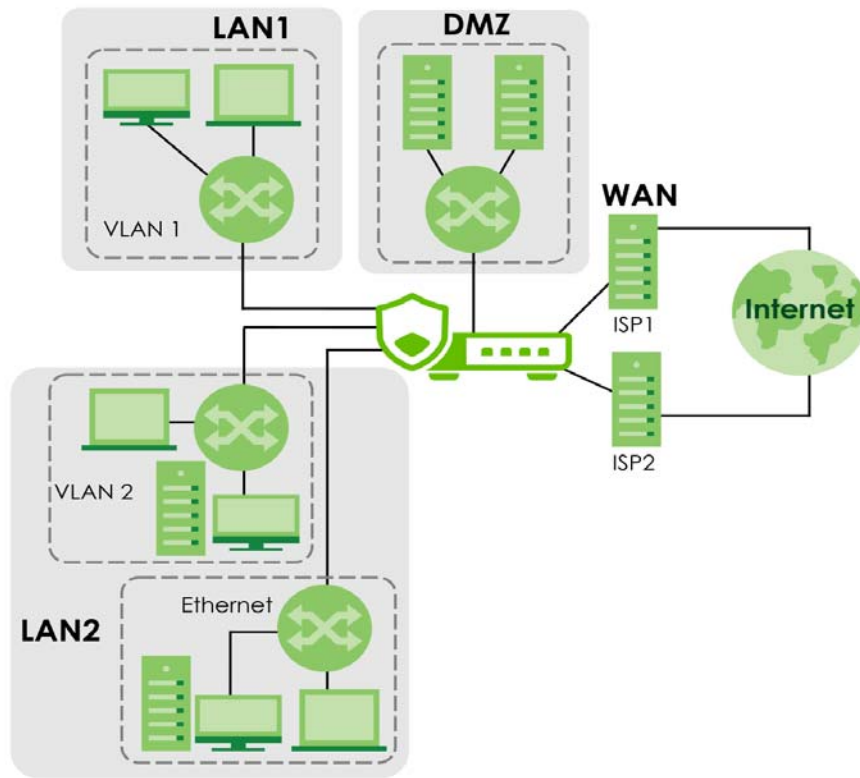

Use the **Zone** screens (see [Section 15.4.2 on page 277](#)) to manage the Zyxel Device's zones.

15.3.1 What You Need to Know

Zones effectively divide traffic into three types--intra-zone traffic, inter-zone traffic, and extra-zone traffic.

Intra-zone Traffic

- Intra-zone traffic is traffic between interfaces or VPN tunnels in the same zone. For example, in [Figure 184 on page 274](#), traffic between VLAN 2 and the Ethernet is intra-zone traffic.

Inter-zone Traffic

Inter-zone traffic is traffic between interfaces or VPN tunnels in different zones. For example, in [Figure 184 on page 274](#), traffic between VLAN 1 and the Internet is inter-zone traffic. This is the normal case when zone-based security and policy settings apply.

Extra-zone Traffic

- Extra-zone traffic is traffic to or from any interface or VPN tunnel that is not assigned to a zone. For example, in [Figure 184 on page 274](#), traffic to or from computer C is extra-zone traffic.
- Some zone-based security and policy settings may apply to extra-zone traffic, especially if you can set the zone attribute in them to **Any** or **All**. See the specific feature for more information.

15.3.2 The Zone Screen

The **Zone** screen provides a summary of all zones. In addition, this screen allows you to add, edit, and remove zones. To access this screen, click **Object > Zone**.

Figure 185 Object > Zone

Name ↑	Members	Description	Reference
<input type="checkbox"/> DMZ		Default DMZ zone	
<input type="checkbox"/> IPSec_VPN		Default IPSec_VPN zone	
<input type="checkbox"/> LAN	ge3, ge4	Default LAN zone	
<input type="checkbox"/> WAN	ge1, ge2	Default WAN zone	

The following table describes the labels in this screen.

Table 138 Object > Zone

LABEL	DESCRIPTION
User Configuration	The Zyxel Device comes with pre-configured system default zones that you cannot delete. You can create your own zones by clicking Add .
Add	Click this to create a new, user-configured zone.
Edit	Double-click an entry or select it and click Edit to open a screen where you can modify the entry's settings.
Remove	To remove a user-configured trunk, select it and click Remove . The Zyxel Device confirms you want to remove it before doing so.
Reference	Select an entry and click Reference to check which settings use the entry.
Name	This field displays the name of the zone.
Members	This field displays the names of the interfaces that belong to each zone.
Description	This field displays the description of the zone.
Reference	This field displays the number of times an Object Reference is used in a policy.

15.3.2.1 Zone Edit

The **Zone Edit** screen allows you to add or edit a zone. To access this screen, go to the **Zone** screen (see [Section 15.4.2 on page 277](#)), and click the **Add** icon or an **Edit** icon.

Figure 186 Object > Zone > Add

The following table describes the labels in this screen.

Table 139 Object > Zone > Add/Edit

LABEL	DESCRIPTION
Name	For a system default zone, the name is read only. For a user-configured zone, type the name used to refer to the zone. You may use 2-30 single-byte characters, including 0-9a-zA-Z_-, but the first character cannot be a number. This value is case-sensitive.
Description	Enter the description associated with the zone, if any. You can use 1 to 30 single-byte characters, including 0-9a-zA-Z!"#\$%&'()*+,-/;:=?@_&.<[\\{ }^'are not allowed.
Search	Type an item in the search box, then click this to display all address objects in the table below according to the item you typed.
Select All	Select this to select all address objects and address groups in the table.
Member List	The list on the left displays the interfaces and VPN tunnels that do not belong to any zone. Select the interfaces and VPN tunnels that you want to add to the zone you are editing, and click the right arrow button to add them. The list on the right displays the interfaces and VPN tunnels that belong to the zone. Select any interfaces that you want to remove from the zone, and click the left arrow button to remove them.
Apply	Click Apply to save your customized settings and exit this screen.
Cancel	Click Cancel to return the screen to its last-saved settings.

15.4 Schedule Overview

Use schedules to set up one-time and recurring schedules for policy routes, security policies, application patrol, and content filtering. The Zyxel Device supports one-time and recurring schedules. One-time schedules are effective only once, while recurring schedules usually repeat. Both types of schedules are based on the current date and time in the Zyxel Device.

Note: Schedules are based on the Zyxel Device's current date and time.

- Use the **Schedule** summary screen ([Section 15.4.2 on page 277](#)) to see a list of all schedules in the Zyxel Device.
- Use the **One-Time Schedule Add/Edit** screen ([Section 15.4.2.1 on page 278](#)) to create or edit a one-time schedule.
- Use the **Recurring Schedule Add/Edit** screen ([Section 15.4.2.2 on page 280](#)) to create or edit a recurring schedule.
- Use the **Schedule Group** screen ([Section 15.4.3 on page 281](#)) to merge individual schedule objects as one object.

15.4.1 What You Need to Know

One-time Schedules

One-time schedules begin on a specific start date and time and end on a specific stop date and time. One-time schedules are useful for long holidays and vacation periods.

Recurring Schedules

Recurring schedules begin at a specific start time and end at a specific stop time on selected days of the week (Sunday, Monday, Tuesday, Wednesday, Thursday, Friday, and Saturday). Recurring schedules always begin and end in the same day. Recurring schedules are useful for defining the workday and off-work hours.

15.4.2 The Schedule Screen

The **Schedule** screen provides a summary of all schedules in the Zyxel Device. To access this screen, click **Object > Schedule**.

Figure 187 Object > Schedule

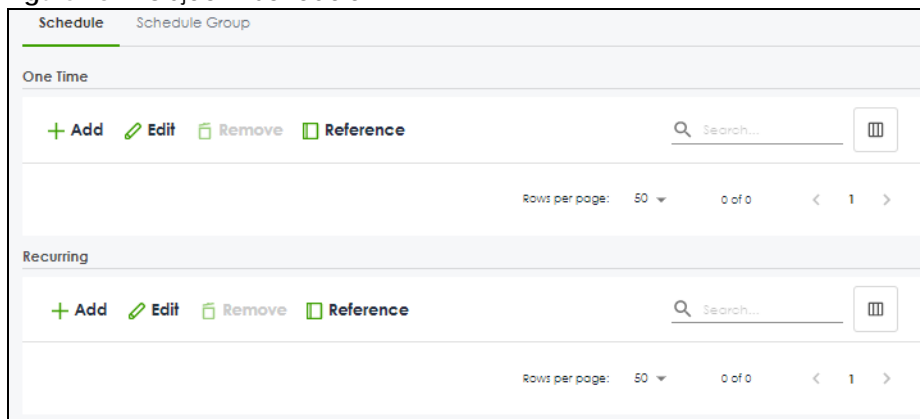

The following table describes the labels in this screen. See [Section 15.4.2.1 on page 278](#) and [Section 15.4.2.2 on page 280](#) for more information as well.

Table 140 Object > Schedule

LABEL	DESCRIPTION
One Time	
Add	Click this to create a new entry.
Edit	Double-click an entry or select it and click Edit to be able to modify the entry's settings.
Remove	To remove an entry, select it and click Remove . The Zyxel Device confirms you want to remove it before doing so.
Reference	Select an entry and click Reference to check which settings use the entry.
Name	This field displays the name of the schedule, which is used to refer to the schedule.
Start Day / Time	This field displays the date and time at which the schedule begins.
Stop Day / Time	This field displays the date and time at which the schedule ends.
Reference	This displays the number of times an object reference is used in a profile.
Recurring	
Add	Click this to create a new entry.
Edit	Double-click an entry or select it and click Edit to be able to modify the entry's settings.
Remove	To remove an entry, select it and click Remove . The Zyxel Device confirms you want to remove it before doing so.
Reference	Select an entry and click Reference to check which settings use the entry.
Name	This field displays the name of the schedule, which is used to refer to the schedule.
Start Time	This field displays the time at which the schedule begins.
Stop Time	This field displays the time at which the schedule ends.
Reference	This displays the number of times an object reference is used in a profile.

15.4.2.1 The One-Time Schedule Add/Edit Screen

The **One-Time Schedule Add/Edit** screen allows you to define a one-time schedule or edit an existing one. To access this screen, go to the **Schedule** screen (see [Section 15.4.2 on page 277](#)), and click either the **Add** icon or an **Edit** icon in the **One Time** section.

Figure 188 Object > Schedule > Edit (One Time)

The following table describes the labels in this screen.

Table 141 Object > Schedule > Edit (One Time)

LABEL	DESCRIPTION
Configuration	
Name	Type the name used to refer to the one-time schedule. You may use 2-30 single-byte characters, including 0-9a-zA-Z, underscores(_), or dashes (-), but the first character cannot be a number. This value is case-sensitive.
Description	Type a description used to identify the one-time schedule. You may use 1-30 single-byte characters, including 0-9a-zA-Z'()+,./:=?;!*#@\$_%-"
Day Time	
Start	Specify the year, month, and day when the schedule begins. <ul style="list-style-type: none"> • Year - 1900 - 2999 • Month - 1 - 12 • Day - 1 - 31 (it is not possible to specify illegal dates, such as February 31.) Specify the hour and minute when the schedule begins. <ul style="list-style-type: none"> • Hour - 1-12 AM/PM • Minute - 0 - 59
Stop	Specify the year, month, and day when the schedule ends. <ul style="list-style-type: none"> • Year - 1900 - 2999 • Month - 1 - 12 • Day - 1 - 31 (it is not possible to specify illegal dates, such as February 31.) Specify the hour and minute when the schedule ends. <ul style="list-style-type: none"> • Hour - 1-12 AM/PM • Minute - 0 - 59
Apply	Click Apply to save your customized settings and exit this screen.
Cancel	Click Cancel to return the screen to its last-saved settings.

15.4.2.2 The Recurring Schedule Add/Edit Screen

The **Recurring Schedule Add/Edit** screen allows you to define a recurring schedule or edit an existing one. To access this screen, go to the **Schedule** screen (see [Section 15.4.2 on page 277](#)), and click either the **Add** icon or an **Edit** icon in the **Recurring** section.

Figure 189 Object > Schedule > Edit (Recurring)

The **Year**, **Month**, and **Day** columns are not used in recurring schedules and are disabled in this screen. The following table describes the remaining labels in this screen.

Table 142 Object > Schedule > Edit (Recurring)

LABEL	DESCRIPTION
Configuration	
Name	Type the name used to refer to the recurring schedule. You may use 2-30 single-byte characters, including 0-9a-zA-Z, underscores(_), or dashes (-), but the first character cannot be a number. This value is case-sensitive.
Description	Type a description used to identify the one-time schedule. You may use 1-30 single-byte characters, including 0-9a-zA-Z'()+,/:=?:!*#@\$_%-"
Date Time	
StartTime	Specify the hour and minute when the schedule begins each day. Then, select each day of the week the recurring schedule is effective. <ul style="list-style-type: none"> • Hour - 1-12 AM/PM • Minute - 0 - 59
StopTime	Specify the hour and minute when the schedule ends each day. Then, select each day of the week the recurring schedule is effective. <ul style="list-style-type: none"> • Hour - 1-12 AM/PM • Minute - 0 - 59
Apply	Click Apply to save your customized settings and exit this screen.
Cancel	Click Cancel to return the screen to its last-saved settings.

15.4.3 The Schedule Group Screen

The **Schedule Group** screen provides a summary of all groups of schedules in the Zyxel Device. To access this screen, click **Object > Schedule > Schedule Group**.

Figure 190 Object > Schedule > Schedule Group

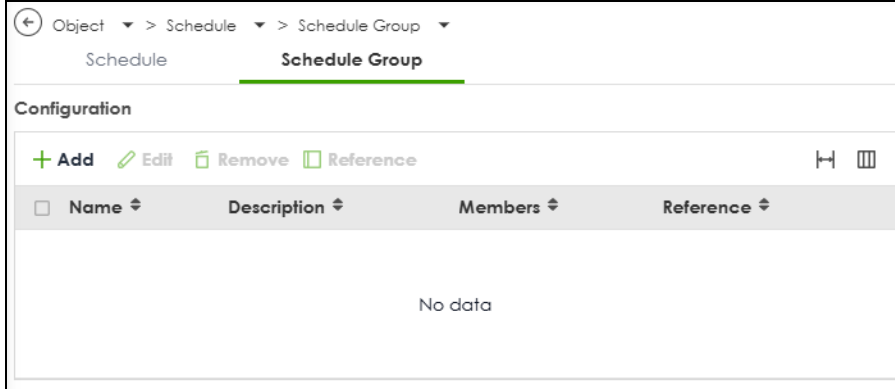

The following table describes the fields in the above screen.

Table 143 Object > Schedule > Schedule Group

LABEL	DESCRIPTION
Configuration	
Add	Click this to create a new entry.
Edit	Double-click an entry or select it and click Edit to be able to modify the entry's settings.
Remove	To remove an entry, select it and click Remove . The Zyxel Device confirms you want to remove it before doing so.
Reference	Select an entry and click Reference to check which settings use the entry.
Name	This field displays the name of the schedule group, which is used to refer to the schedule.
Description	This field displays the description of the schedule group.
Members	This field lists the members in the schedule group. Each member is separated by a comma.
Reference	This displays the number of times an object reference is used in a profile.

15.4.3.1 The Schedule Group Add/Edit Screen

The **Schedule Group Add/Edit** screen allows you to define a schedule group or edit an existing one. To access this screen, go to the **Schedule** screen (see), and click either the **Add** icon or an **Edit** icon in the **Schedule Group** section.

Figure 191 Object > Schedule > Schedule Group > Add

The following table describes the fields in the above screen.

Table 144 Object > Schedule > Schedule Group > Add

LABEL	DESCRIPTION
Group Members	
Name	Type the name used to refer to the recurring schedule. You may use 2-30 single-byte characters, including 0-9a-zA-Z, underscores(_), or dashes (-), but the first character cannot be a number. This value is case-sensitive.
Description	Enter a description of the service group, if any. You can use 1 to 30 single-byte characters, special characters and spaces are allowed.
Member List	
Add Object	Click this button to create an address object. See Section 15.1.2.1 on page 258 for more information on configuring an address object.
Search	Type an item in the search box, then click this to display all address objects in the table below according to the item you typed.
Select All	Select this to select all address objects and address groups in the table.
Member List	This list displays the names of the service and service group objects that have been added to the service group. The order of members is not important. Select items from the list on the left that you want to be members and move them to the list on the right. Move any members you do not want included to the list on the left.
Apply	Click Apply to save your customized settings and exit this screen.
Cancel	Click Cancel to return the screen to its last-saved settings.

CHAPTER 16

Application Patrol

16.1 Overview

Application patrol provides a convenient way to manage the use of various applications on the network. It manages general protocols (for example, HTTP and FTP) and instant messenger (IM), peer-to-peer (P2P), Voice over IP (VoIP), and streaming (RSTP) applications. You can even control the use of a particular application's individual features (like text messaging, voice, video conferencing, and file transfers).

If a license has expired, you will see a reminder in this screen. You need to renew the license in order to keep using the feature. Click **Buy Now** to go to Marketplace to purchase a new license. Click **See Details** to go to the Zyxel web page to find more information on licenses for your Zyxel Device.

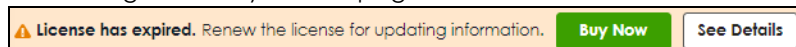

16.1.1 What You Can Do in this Chapter

- Use the **App Patrol** summary screen (see [Section 16.2 on page 284](#)) to manage the application patrol profiles. You can also view license registration and signature information.
- Use the **App Patrol Add/Edit** screens (see [Section 16.2.1 on page 286](#)) to set actions for application categories and for specific applications within the category.

16.1.2 What You Need to Know

If you want to use a service, make sure both the Security Policy and application patrol allow the service's packets to go through the Zyxel Device.

Note: The Zyxel Device checks secure policies before it checks application patrol rules for traffic going through the Zyxel Device.

Application patrol examines every TCP and UDP connection passing through the Zyxel Device and identifies what application is using the connection. Then, you can specify whether or not the Zyxel Device continues to route the connection. Traffic not recognized by the application patrol signatures is ignored.

Application Profiles & Policies

An application patrol profile is a group of categories of application patrol signatures. For each profile, you can specify the default action the Zyxel Device takes once a packet matches a signature (forward, drop, or reject a service's connections and/or create a log alert).

Use policies to link profiles to traffic flows based on criteria such as source zone, destination zone, source address, destination address, schedule, user.

Classification of Applications

There are two ways the Zyxel Device can identify the application. The first is called auto. The Zyxel Device looks at the IP payload (OSI level-7 inspection) and attempts to match it with known patterns for specific applications. Usually, this occurs at the beginning of a connection, when the payload is more consistent across connections, and the Zyxel Device examines several packets to make sure the match is correct. Before confirmation, packets are forwarded by App Patrol with no action taken. The number of packets inspected before confirmation varies by signature.

Note: The Zyxel Device allows the first eight packets to go through the security policy, regardless of the application patrol policy for the application. The Zyxel Device examines these first eight packets to identify the application.

The second approach is called service ports. The Zyxel Device uses only OSI level-4 information, such as ports, to identify what application is using the connection. This approach is available in case the Zyxel Device identifies a lot of "false positives" for a particular application.

Custom Ports for SIP and the SIP ALG

Configuring application patrol to use custom port numbers for SIP traffic also configures the SIP ALG to use the same port numbers for SIP traffic. Likewise, configuring the SIP ALG to use custom port numbers for SIP traffic also configures application patrol to use the same port numbers for SIP traffic.

16.2 Application Patrol Profile

Use the application patrol screens to customize action and log settings for a group of application patrol signatures. You then link a profile to a policy. Use this screen to create an application patrol profile, and view signature information. It also lists the details about the signature set the Zyxel Device is using.

Note: You must register for the AppPatrol signature service (at least the trial) before you can use it.

A profile is an application object(s) or application group(s) that has customized action and log settings.

Click **Security Service > App Patrol** to open the following screen.

Click the **Application Patrol** icon for more information on the Zyxel Device's security features.

Figure 192 Security Service > App Patrol

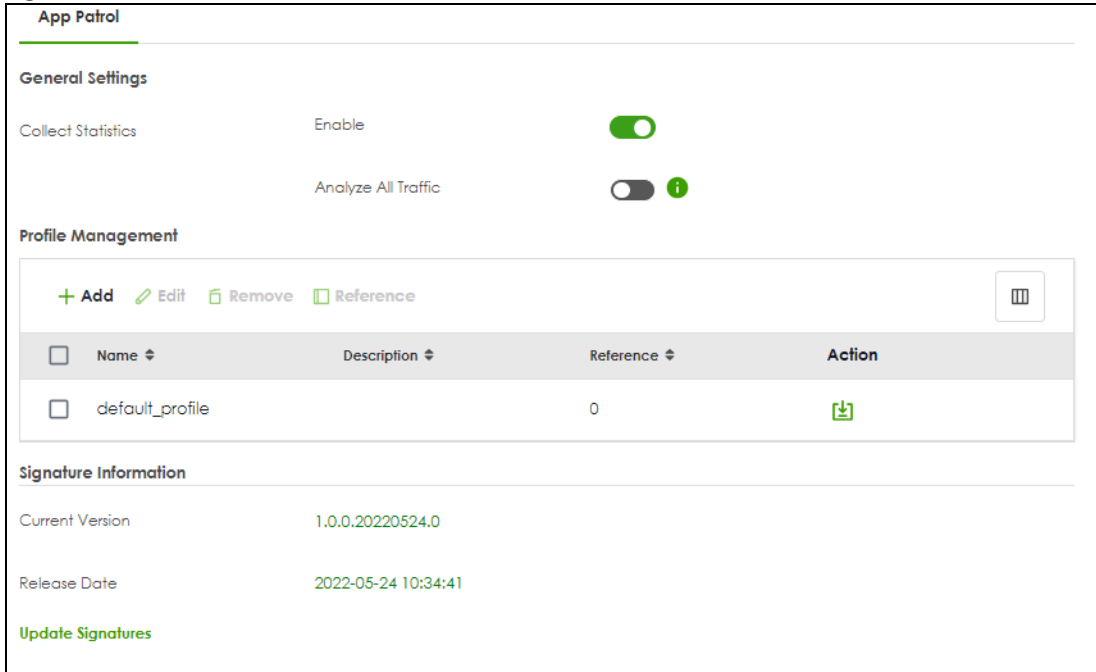

The following table describes the labels in this screen.

Table 145 Security Service > App Patrol

LABEL	DESCRIPTION
Collect Statistics	
Enable	Enable to have the Zyxel Device collect app patrol statistics. All of the statistics are erased if you restart the Zyxel Device or click Flush Data in Security Statistics > App Patrol .
Analyze All Traffic	Enable to have the Zyxel Device collect app patrol statistics from all Zyxel Device traffic. Disable to have the Zyxel Device only collect app patrol statistics from the traffic that matches the policy control rules with app patrol profiles applied. For example, if you create an app patrol profile and apply it to the policy control rule LAN_Outgoing , the Zyxel Device will only collect app patrol statistics from the traffic that matches the policy control rule LAN_Outgoing .
Add	Click this to create a new entry. Select an entry and click Add to create a new entry after the selected entry.
Edit	Select an entry and click Edit to open a screen where you can modify the entry's settings.
Remove	Select an entry and click Remove to delete the selected entry.
Reference	Select an entry and click Reference to check which settings use the entry.
Name	This displays the name of the profile created.
Description	This displays the description of the App Patrol Profile.
Reference	This displays the number of times an object reference is used in a profile.
Action	Click this icon to apply the entry to a policy control rule. Go to the Security Policy > Policy Control screen to check the result.
Signature Information	The following fields display information on the current signature set that the Zyxel Device is using.
Current Version	This field displays the App Patrol signature set version number.

Table 145 Security Service > App Patrol

LABEL	DESCRIPTION
Released Date	This field displays the date and time the set was released.
Update Signatures	Click this link to go to the screen you can use to download signatures from the update server.

16.2.1 Application Patrol Profile > Add/Edit - Application Management

Use this screen to configure profile settings. Click **Security Service > App Patrol > Add/Edit** to open the following screen.

Figure 193 Security Service > App Patrol > Add/Edit > Application Management

Security Services > App Patrol

General Settings

Name: APP7858

Description:

Application Management

+ Add Remove Active Inactive Log More

Priority	Status	Category	Application
1	Active	Antivirus	360 Safeguard - 360 Total Secu
2	Active	Audio/Video	BBC Player





Some changes were made
What do you want to do then?
Cancel Apply

The following table describes the labels in this screen.

Table 146 Security Service > App Patrol > Add/Edit > Application Management

LABEL	DESCRIPTION
General Settings	
Name	Type the name of the profile. You may use 1-31 alphanumeric characters, underscores (_), or dashes (-), but the first character cannot be a number. This value is case-sensitive. These are valid, unique profile names: <ul style="list-style-type: none"> MyProfile mYProfile Mymy12_3-4 These are invalid profile names: <ul style="list-style-type: none"> 1mYProfile My Profile MyProfile? Whatalongprofilename123456789012
Description	Type a description for the profile rule to help identify the purpose of rule. You may use 1-31 alphanumeric characters, underscores (_), or dashes (-), but the first character cannot be a number. This value is case-sensitive. This field is optional.
Add	Click Add to create a new profile.

Table 146 Security Service > App Patrol > Add/Edit > Application Management

LABEL	DESCRIPTION
Remove	To remove a profile, select it and click Remove . The Zyxel Device confirms you want to remove it before doing so.
Active	To turn on an entry, select it and click Active . The Status light changes accordingly.
Inactive	To turn off an entry, select it and click Inactive . The Status light changes accordingly.
Edit	Select an entry and click this icon to modify it. 
Remove	Select an entry and click this icon to delete it. 
Save Changes	Click this icon to save the changes in this row. 
Cancel Changes	Click this icon to cancel the changes in this row. 
Log	Select whether to have the Zyxel Device generate a log (log), log and alert (log alert) or neither (no) by default when traffic matches a signature in this category.
Action	Select the default action for all signatures in this category. forward - the Zyxel Device routes packets that matches these signatures. drop - the Zyxel Device silently drops packets that matches these signatures without sending a TCP RST or ICMP host unreachable message to both the sender and receiver. reject - the Zyxel Device drops packets that matches these signatures and sends a TCP RST or ICMP host unreachable message to both the sender and receiver.
Priority	This field is a sequential value showing the number of the profile. The ordering of your profiles is important as profiles are applied in sequence.
Status	
Category	This field displays the category type of the application.
Application	This field displays the application name or numbers of applications included in the policy.
Log	Select whether to have the Zyxel Device generate a log (log), log and alert (log alert) or neither (no) by default when traffic matches a signature in this category.
Action	Select the default action for all signatures in this category. forward - the Zyxel Device routes packets that matches these signatures. drop - the Zyxel Device silently drops packets that matches these signatures without notification. reject - the Zyxel Device drops packets that matches these signatures and sends notification.
Apply	Click Apply to save your settings to the Zyxel Device.
Cancel	Click Cancel to return to the profile summary page without saving any changes.

16.3 Example: Block an Application

In this example, you want to block clients on the Zyxel Device LAN from accessing a specific application (for example, TikTok). You also want to receive a log and an alert when traffic going out from the LAN tries to access TikTok.

Create an **App Patrol** profile that includes TikTok,. Then apply it to the **LAN_Outgoing** security policy. Clients on the Zyxel Device LAN will be blocked from accessing TikTok.

Figure 194 App Patrol Tutorial Example

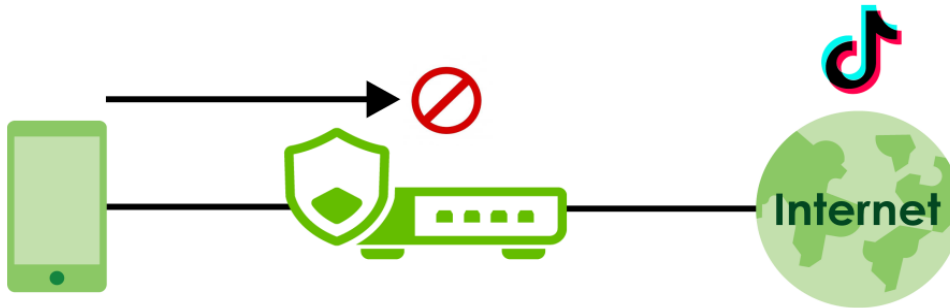

This example uses the parameters listed below.

Table 147 App Patrol Profile Configuration Example

PROFILE NAME	APPLICATION	ACTION	LOG
BlockMedia	TikTok	Reject	Log Alert

Table 148 Security Policy Configuration Example

TO	FROM	LOG	APP PATROL PROFILE
WAN	LAN	By Profile	BlockMedia

- 1 Go to **Security Service > App Patrol** and click **Add**.
- 2 In the following screen, enter the profile name using the parameter given in [Table 147 on page 288](#). Click **Add** under **Application Management** to open the **Add Application** screen.

- 3 Search for TikTok in **Category and Application** and select the checkbox. Set **Log** to **Log Alert** and **Action** to **Reject**. Click **Add** to save your changes.

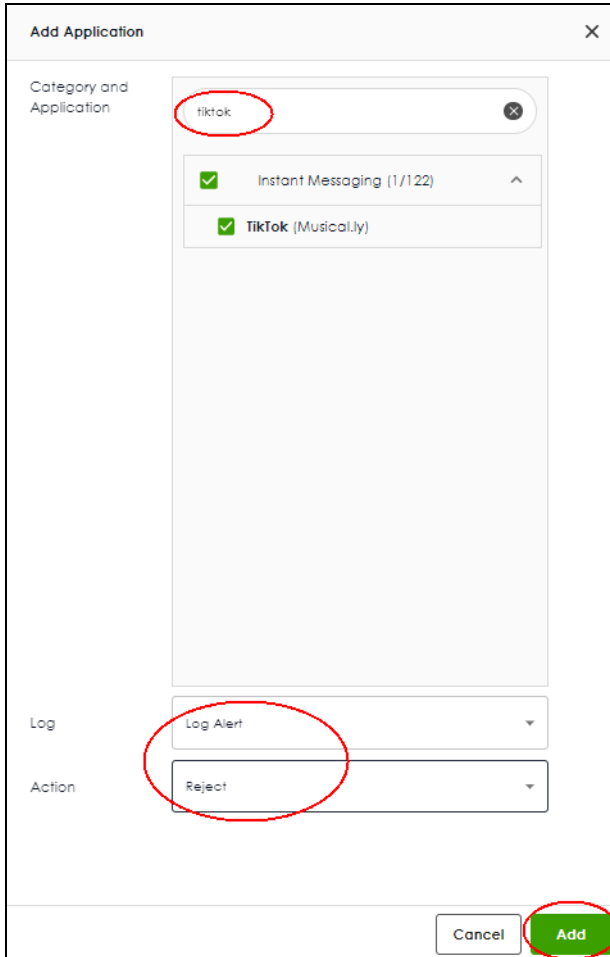

- 4 Click **Apply** to save the app patrol profile.

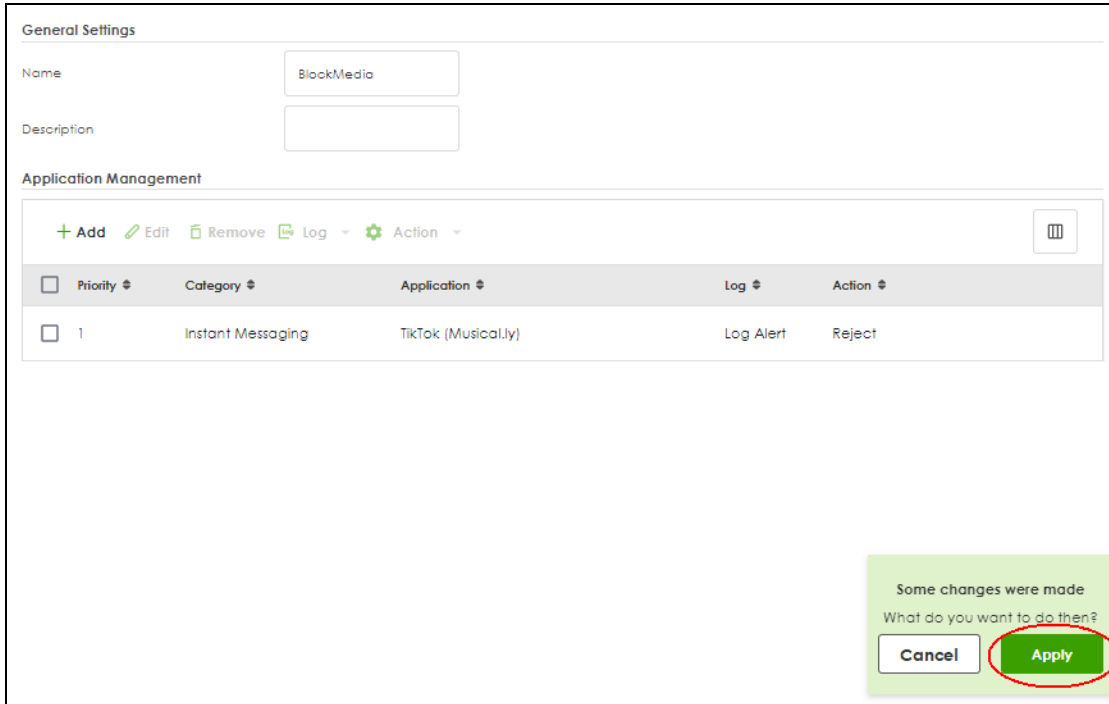

5 Go to Security Policy > Policy Control. Select LAN_Outgoing then click Edit.

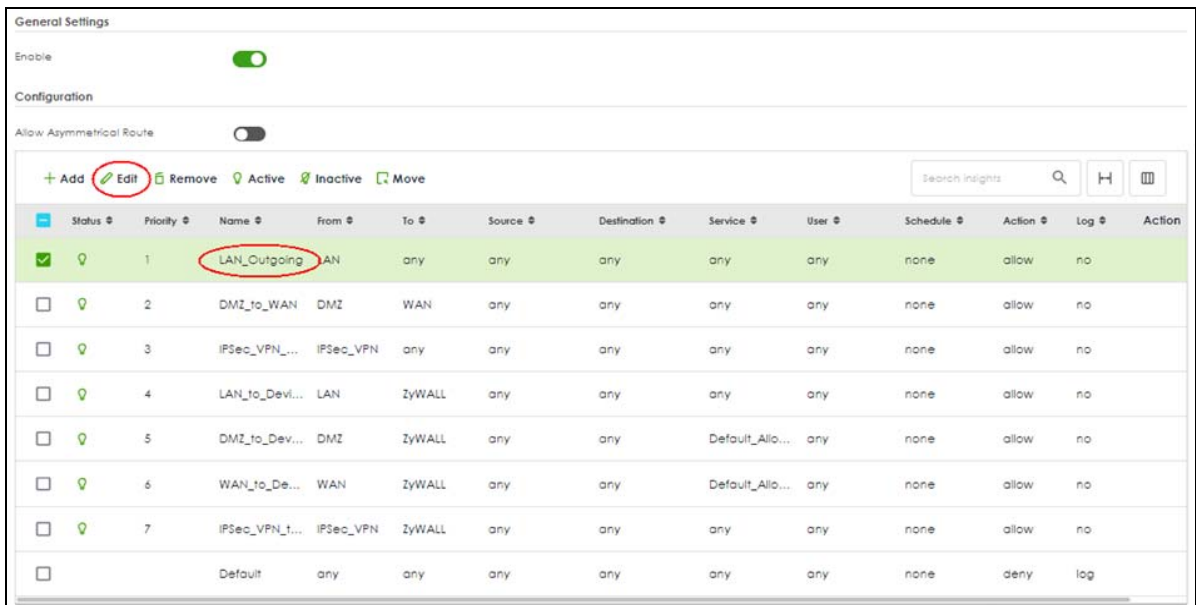

6 Set Application Patrol to BlockMedia and Log to by profile. Click Apply to save your changes.

Configuration

Enable

Name LAN_Outgoing

Description

From LAN 

To any 

Source any 

Destination any 

Service any 

User any 

Schedule none 

Action allow ▼

Log no ▼

Profile

Application Patrol	<input type="text" value="BlockMedia"/>	Log	<input type="text" value="by profile"/>
Content Filter	<input type="text" value="none"/>	Log	<input type="text" value="by profile"/>
SSL Inspection	<input type="text" value="none"/>	Log	<input type="text" value="by profile"/>

Some changes were made
What do you want to do then?

- 7 You can check the result in the **Policy Control** screen. Mouse-over the icon under the **Action** column to check that the **BlockMedia** profile has been applied to the **LAN_Outgoing** security policy. You can also check the logs in **Log & Report > Log / Events**. The Zyxel Device will create logs if the clients on the Zyxel Device LAN try to access TikTok.

General Settings

Enable

Configuration

Allow Asymmetrical Route

+ Add Edit Remove Active Inactive Move

Search Insights

<input type="checkbox"/>	Status	Priority	Name	From	To	Source	Destination	Service	User	Schedule	Action	Log	Action
<input type="checkbox"/>	Active	1	LAN_Outgoing	LAN	any	any	any	any	any	none	allow	no	
<input type="checkbox"/>	Active	2	DMZ_to_WAN	DMZ	WAN	any	any	any	any	none	allow	no	
<input type="checkbox"/>	Active	3	IPSec_VPN_Outgoing	IPSec_VPN	any	any	any	any	any	none	allow	no	
<input type="checkbox"/>	Active	4	LAN_to_Device	LAN	ZyWALL	any	any	any	any	none	allow	no	
<input type="checkbox"/>	Active	5	DMZ_to_Device	DMZ	ZyWALL	any	any	Default_Alo...	any	none	allow	no	
<input type="checkbox"/>	Active	6	WAN_to_Device	WAN	ZyWALL	any	any	Default_Alo...	any	none	allow	no	
<input type="checkbox"/>	Active	7	IPSec_VPN_to_Device	IPSec_VPN	ZyWALL	any	any	any	any	none	allow	no	
<input type="checkbox"/>			Default	any	any	any	any	any	any	none	allow	log	

CHAPTER 17

Content Filtering

17.1 Overview

Use the content filter feature to control access to specific web sites or web content.

If a license has expired, you will see a reminder in this screen. You need to renew the license in order to keep using the feature. Click **Buy Now** to go to Marketplace to purchase a new license. Click **See Details** to go to the Zyxel web page to find more information on licenses for your Zyxel Device.

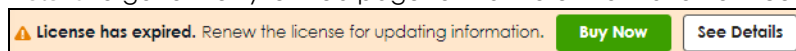

17.1.1 What You Can Do in this Chapter

- Use the **Content Filtering** screens ([Section 17.2 on page 296](#)) to set up web content filtering profiles.
- Use **Content Filtering Allow List** ([Section 17.2.2 on page 311](#)) to create a common list of good (allowed) web site addresses.
- Use **Content Filtering Block List** ([Section 17.2.3 on page 312](#)) to create a common list of bad (blocked) web site addresses.
- Use **Content Filtering Blocked URL keywords** ([Section 17.2.4 on page 313](#)) to create a common list of bad (blocked) URL keywords.

17.1.2 What You Need to Know

HTTP(S) Traffic Scan

The HTTP(S) Traffic Scan allows the Zyxel Device to block access to specific websites, by inspecting the URL or Server Name Indication (SNI) that the user's web browser sends to the web server.

HTTP(S) Traffic Scanning Process

- 1 The Zyxel Device Content Filter detects an HTTP(S) connection, and inspects the website sent.
- 2 If the website contains prohibited material, the HTTP(S) request is redirected to a block page.

Note: If the user's web browser is using encryption, then you must enable SSL Inspection for HTTP(S) Traffic Scan to work.

Content Filtering Policies

A content filter policy allows you to do the following.

- Use schedule objects to define when to apply a content filter profile.

- Use address and/or user/group objects to define to whose web access to apply the content filter profile.
- Apply a content filter profile that you have custom-tailored.

Content Filtering Profiles

A content filtering profile conveniently stores your custom settings for the following features.

- **Category-based Blocking**
The Zyxel Device can block access to particular categories of web site content, such as pornography or racial intolerance.
- **Customize Web Site Access**
You can specify URLs to which the Zyxel Device blocks access. You can alternatively block access to all URLs except ones that you specify. You can also have the Zyxel Device block access to URLs that contain particular keywords.

HTTP(S) Traffic Scanning Configuration Guidelines

When the Zyxel Device receives an HTTP request, the content filter searches for a policy that matches the source address and time (schedule). The content filter checks the policies in order (based on the policy numbers). When a matching policy is found, the content filter allows or blocks the request depending on the settings of the filtering profile specified by the policy. Some requests may not match any policy. The Zyxel Device allows the request if the default policy is not set to block. The Zyxel Device blocks the request if the default policy is set to block.

HTTPS Domain Filter

HTTPS Domain Filter works with the Content Filter category feature to identify HTTPS traffic and take appropriate action. SSL Inspection identifies HTTPS traffic for all Security Service traffic and has higher priority than HTTPS Domain Filter. HTTPS Domain Filter only identifies keywords in the domain name of an URL and matches it to a category. For example, if the keyword is 'picture' and the URL is <http://www.google.com/picture/index.htm>, then HTTPS Domain Filter cannot identify 'picture' because that keyword is not in the domain name 'www.google.com'. However, SSL Inspection can identify 'picture' in the URL <http://www.google.com/picture/index.htm>.

Keyword Blocking URL Checking

The Zyxel Device checks the URL's domain name (or IP address) and file path separately when performing keyword blocking.

The URL's domain name or IP address is the characters that come before the first slash in the URL. For example, with the URL www.zyxel.com.tw/news/pressroom.php, the domain name is www.zyxel.com.tw.

The file path is the characters that come after the first slash in the URL. For example, with the URL www.zyxel.com.tw/news/pressroom.php, the file path is [news/pressroom.php](http://www.zyxel.com.tw/news/pressroom.php).

Since the Zyxel Device checks the URL's domain name (or IP address) and file path separately, it will not find items that go across the two. For example, with the URL www.zyxel.com.tw/news/pressroom.php, the Zyxel Device would find "tw" in the domain name (www.zyxel.com.tw). It would also find "news" in the file path ([news/pressroom.php](http://www.zyxel.com.tw/news/pressroom.php)) but it would not find "tw/news".

DNS Domain Scan

The DNS Domain Scan allows the Zyxel Device to block access to specific websites by inspecting DNS queries made by users on your network. If the website in the DNS query contains prohibited material, then the Zyxel Device replies to the DNS query with a IP address that points to the block page. Unlike the HTTP(S) Traffic Scan, the DNS Domain Scan works if the user is using TLS 1.3 with ESNI.

DNS Domain Scan Process

- 1 A user enters a URL into their web browser.
- 2 The user's computer sends a DNS query for the URL.
- 3 The DNS Domain Scan inspects the website in the DNS query packet.

If the website contains prohibited material, the DNS reply is redirected to a block page. [Finding Out More](#)

- 4 See [Section 17.3 on page 315](#) for content filtering background/technical information.

External Category-Based Content Filtering Server

When you register for and enable the external content filtering service, your Zyxel Device accesses an external database that has millions of web sites categorized based on content. You can have the Zyxel Device block, block and/or log access to web sites based on these categories.

External Content Filtering Server Lookup Procedure

The content filtering lookup process is described below.

Figure 195 Content Filtering Lookup Procedure



- 1 A computer behind the Zyxel Device tries to access a web site.
- 2 The Zyxel Device looks up the web site in its cache. If an attempt to access the web site was made in the past, a record of that web site's category will be in the Zyxel Device's cache. The Zyxel Device blocks, blocks and logs or just logs the request based on your configuration.
- 3 If the Zyxel Device has no record of the web site, it queries the external content filtering database.
- 4 The external content filtering server sends the category information back to the Zyxel Device, which then blocks and/or logs access to the web site based on the settings in the content filter profile. The web site's address and category are then stored in the Zyxel Device's content filter cache.

17.2 Content Filtering General Screen

Click **Security Services > Content Filtering > General** to open the **Content Filtering** screen. Use this screen to enable HTTP(S), DNS domain scanning, test website categories and view / create content filter policies.

Figure 196 Security Service > Content Filtering_General

Security Services > Content Filtering

General Settings

For HTTP(S) traffic scan

HTTPS Domain Filter Enable

Enable Block Page

Blocked Site

Denied Access Message

Redirect URL

For DNS Domain scan

Enable DNS Domain scan

Blocked Domain

Redirect IP

Category Server is unavailable

Action

Log

Collect Statistics

Test Web Site Category

URL to test

If you think the category is incorrect, click this link to submit a request to review it.

Profile Management

+ Add Edit Remove Reference

Search insights

Name	Description	Reference
<input type="checkbox"/> BPP	Business Productivity Protection	0
<input type="checkbox"/> CIP	Children's Internet Protection	0

The following table describes the labels in this screen.

Table 149 Security Service > Content Filtering > General

LABEL	DESCRIPTION
For HTTP(S) traffic scan	
Enable	Select this check box to have the Zyxel Device block HTTPS web pages using the cloud category service. In an HTTPS connection, the Zyxel Device can extract the Server Name Indication (SNI) from a client request, check if it matches a category in the cloud content filter and then take appropriate action. The keyword match is for the domain name only.
Enable Block Page	Use this field to have the Zyxel Device display a warning page instead of a blank page when an HTTPS connection is redirected.

Table 149 Security Service > Content Filtering > General (continued)

LABEL	DESCRIPTION
Denied Access Message	<p>Enter a message to be displayed when content filter blocks access to a web page. Use up to 127 characters (0-9a-zA-Z;/?:@&=#\$\._!~*()%,"). For example, "Access to this web page is not allowed. Please contact the network administrator".</p> <p>It is also possible to leave this field blank if you have a URL specified in the Redirect URL field. In this case if the content filter blocks access to a web page, the Zyxel Device just opens the web page you specified without showing a denied access message.</p>
Redirect URL	<p>Enter the URL of the web page to which you want to send users when their web access is blocked by content filter. The web page you specify here opens in a new frame below the denied access message.</p> <p>Use "http://" or "https://" followed by up to 262 characters (0-9a-zA-Z;/?:@&=#\$\._!~*()%,"). For example, http://192.168.1.17/blocked access.</p>
For DNS Domain scan	
Enable DNS Domain scan	Select this to have the Zyxel Device inspect DNS queries made by users on your network.
Blocked Domain	<p>This is the URL of the web page to which you want to send users when their web access is blocked by DNS content filtering. The web page you specify here opens in a new frame below the denied access message.</p> <p>Select default to send users to the default web page when their web access is blocked by DNS content filter.</p> <p>Select custom-defined to send users to the web page you set when their web access is blocked by DNS content filter. Use "http://" followed by up to 255 characters (0-9 a-z A-Z;/?:@&=#\$\._!~*()%) in quotes. For example, http://192.168.2.17/blocked access.</p>
Category Server is unavailable	<p>Select Pass to allow users to access any requested web page if the external content filtering database is unavailable.</p> <p>Select Block to block access to any requested web page if the external content filtering database is unavailable.</p> <p>The following are possible causes for the external content filtering server not being available:</p> <ul style="list-style-type: none"> • There is no response from the external content filtering server within the time period specified in the Content Filter Server Unavailable Timeout field. • The Zyxel Device is not able to resolve the domain name of the external content filtering database. • There is an error response from the external content filtering database. This can be caused by an expired content filtering registration (External content filtering's license key is invalid"). <p>Select Log to record attempts to access web pages that occur when the external content filtering database is unavailable.</p>
Collect Statistics	Enable to have the Zyxel Device collect content filtering statistics. All of the statistics are erased if you restart the Zyxel Device or click Flush Data in Security Statistics > Content Filter .
Test Web Site Category	
URL to test	<p>Enter a web site URL in the text box.</p> <p>When content filtering is active, you should see the web page's category. The query fails if content filtering is not active.</p> <p>Content Filterilg can query a category by full URL string (for example, http://www.google.com/picture/index.html), but HTTPS domain filter can only query a category by domain name (www.google.com), so the category may be different in the query result. URL to test displays both results in the test.</p>

Table 149 Security Service > Content Filtering > General (continued)

LABEL	DESCRIPTION
If you think the category is incorrect, click this link to submit a request to review it.	Click this link to see the category recorded in the Zyxel Device's content filtering database for the web page you specified (if the database has an entry for it).
Profile Management	
Add	Click Add to create a new content filter rule.
Edit	Click Edit to make changes to a content filter rule.
Remove	Click Remove to delete a content filter rule.
Reference	Select an entry and click Reference to check which settings use the entry.
Name	This column lists the names of the content filter profile rule.
Description	This column lists the description of the content filter profile rule.
Reference	This shows the number of references this profile uses.
Action	Click this icon to apply the entry to a policy control rule. Go to the Security Policy > Policy Control screen to check the result.
Apply	Click Apply to save your changes back to the Zyxel Device.
Cancel	Click Cancel to return the screen to its last-saved settings.

17.2.1 Content Filtering Add Profile

Click **Security Service > Content Filtering > Add or Edit** to open the following screen.

Figure 197 Security Service > Content Filter > Add Profile (General & Managed Categories)

The following table describes the labels in this part of the screen.

Table 150 Security Service > Content Filtering > Add Profile (General & Managed Categories)

LABEL	DESCRIPTION
Name	Enter a descriptive name for this content filtering profile name. You may use 1-31 alphanumeric characters, special characters -_@\$. / are allowed, but the first character cannot be a number. This value is case-sensitive.
Description	Enter a description for the content filtering profile rule to help identify the purpose of rule. You may use 1-31 alphanumeric characters, underscores(_), or dashes (-), but the first character cannot be a number. This value is case-sensitive. This field is optional.
Action	Select pass to allow users to access web pages that match the other categories that you select below. Select block to prevent users from accessing web pages that match the other categories that you select below. When external database content filtering blocks access to a web page, it displays the denied access message that you configured in the Content Filter General screen along with the category of the blocked web page.

Table 150 Security Service > Content Filtering > Add Profile (General & Managed Categories)

LABEL	DESCRIPTION
Log	<p>A log at the alert level is a log for serious events that may need more immediate attention. For example, you may want to know right away if there are clients in your networks that try to access adult topics or drugs related web pages.</p> <p>Set the action to block. Then select log to have the Zyxel Device generate logs at the info level or select log alert to have the Zyxel Device generate logs at the alert level.</p> <p>Select no if you don't want the Zyxel Device to generate logs.</p>
Log allowed traffic	Enable to generate logs when users access web pages that match the categories you allow.
SSL V3 or previous version Connection	
Drop	Select this to have the Zyxel Device block HTTPS web pages using SSL V3 or a previous version.
Drop Log	<p>A log at the alert level is a log for serious events that may need more immediate attention. For example, you may want to know right away if there are clients in your networks that try to access adult topics or drugs related web pages.</p> <p>When the Zyxel Device blocks HTTPS web pages using SSL V3 or a previous version,</p> <ul style="list-style-type: none"> • Select no to not generate logs. • Select log to have the Zyxel Device generate logs at the info level. • Select log alert to have the Zyxel Device generate logs at the alert level.
Managed Categories	<p>These are categories of web pages based on their content. Select categories in this section to control access to specific types of Internet content.</p> <p>You must have the Category Service content filtering license to filter these categories. See the next table for category details.</p>
Select All Categories	Select this check box to restrict access to all site categories listed below.
Clear All Categories	Select this check box to clear the selected categories below.
Apply	Click Apply to save your changes back to the Zyxel Device.
Reset	Click Reset to exit this screen without saving your changes.

The following table describes the managed categories.

Table 151 Managed Category Descriptions

CATEGORY	DESCRIPTION
Adult Topics	Web pages that contain content or themes that are generally considered unsuitable for children.
Alcohol	<p>Web pages that mainly sell, promote, or advocate the use of alcohol, such as beer, wine, and liquor.</p> <p>This category also includes cocktail recipes and home-brewing instructions.</p>
Anonymizing Utilities	<p>Web pages that result in anonymous web browsing without the explicit intent to provide such a service.</p> <p>This category includes URL translators, web-page caching, and other utilities that might function as anonymizers, but without the express purpose of bypassing filtering software.</p> <p>This category does not include text translation.</p>
Art Culture Heritage	<p>Web pages that contain virtual art galleries, artist sites (including sculpture and photography), museums, ethnic customs, and country customs.</p> <p>This category does not include online photograph albums.</p>

Table 151 Managed Category Descriptions (continued)

CATEGORY	DESCRIPTION
Auctions Classifieds	<p>Web pages that provide online bidding and selling of items or services.</p> <p>This category includes web pages that focus on bidding and sales.</p> <p>This category does not include classified advertisements such as real estate postings, personal ads, or companies marketing their auctions.</p>
Blogs/Wiki	<p>Web pages containing dynamic content, which often changes because users can post or edit content at any time.</p> <p>This category covers the risks with dynamic content that might range from harmless to offensive.</p>
Business	<p>Web pages that provide business-related information, such as corporate overviews or business planning and strategies.</p> <p>This category also includes information, services, or products that help other businesses plan, manage, and market their enterprises, and multi-level marketing.</p> <p>This category does not include personal pages and web-hosting web pages.</p>
Chat	<p>Web pages that provide web-based, real-time social messaging in public and private chat rooms. This category includes IRC.</p> <p>This category does not include instant messaging.</p>
Computing Internet	<p>Web pages containing reviews, information, buyer's guides of computers, computer parts and accessories, computer software and internet companies, industry news and magazines, and pay-to-surf sites.</p>
Consumer Protection	<p>Websites that try to rob or cheat consumers.</p> <p>Some examples of their activities include selling counterfeit products, selling products that were originally provided for free, or improperly using the brand of another company. This category also includes sites where many consumers reported being cheated or not receiving services.</p> <p>This category does not include phishing, which tries to perpetrate fraud or theft by stealing account information.</p>
Content Server	<p>URLs for servers that host images, media files, or JavaScript for one or more sites and are intended to speed up content retrieval for existing web servers, such as Apache.</p> <p>This category includes domain-level and sub-domain-level URLs that function as content servers.</p> <p>This category does not include:</p> <ul style="list-style-type: none"> • Web pages for businesses that provide the content servers • Web pages that allow users to browse photographs. See the Media Sharing category. • URLs for servers that serve only advertisements. See the Web Ads category.
Controversial Opinions	<p>Web pages that contain opinions that are likely to offend political or social sensibilities and incite controversy. Much of this content is at the extremes of public opinion.</p> <p>This category does not include opinion or language clearly intended to promote hate or discrimination.</p>
Cult Occult	<p>Sites relating to non-traditional religious practices considered to be false, unorthodox, extremist, or coercive.</p>
Dating Personals	<p>Web pages that provide networking for online dating, matchmaking, escort services, or introductions to potential spouses.</p> <p>This category does not include sites that provide social networking that might include dating, but are not specific to dating.</p>

Table 151 Managed Category Descriptions (continued)

CATEGORY	DESCRIPTION
Dating Social Networking	<p>Web pages that focus on social interaction such as online dating, friendship, school reunions, pen-pals, escort services, or introductions to potential spouses.</p> <p>This category does not include wedding-related content, dating tips, or related marketing.</p>
Digital Postcards	<p>Web pages that allow people to send and receive digital postcards and greeting cards via the Internet.</p>
Discrimination	<p>Web pages, which provide information that explicitly encourages the oppression or discrimination of a specific group of individuals.</p> <p>This category does not include jokes and humor, unless the focus of the entire site is considered discriminatory.</p>
Drugs	<p>Websites that provide information on the purchase, manufacture, and use of illegal or recreational drugs.</p> <p>This category does not include sites with exclusive health or political themes.</p>
Education Reference	<p>Web pages devoted to academic-related content such as academic subjects (mathematics, history), school or university web pages, and education administration pages (school boards, teacher curriculum).</p>
Entertainment	<p>Web pages that provide information about cinema, theater, music, television, infotainment, entertainment industry gossip-news, and sites about celebrities such as actors and musicians.</p> <p>This category also includes sites where the content is devoted to providing entertainment on the web, such as horoscopes or fan clubs.</p>
Extreme	<p>Web pages that provide content considered gory, perverse, or horrific.</p>
Fashion Beauty	<p>Web pages that market clothing, cosmetics, jewelry, and other fashion-oriented products, accessories, or services.</p> <p>This category also includes product reviews, comparisons, and general consumer information, and services such as hair salons, tanning salons, tattoo studios, and body-piercing studios.</p> <p>This category does not include fashion-related content such as modeling or celebrity fashion unless the site focuses on marketing the product line.</p>
Finance Banking	<p>Web pages that provide financial information or access to online financial accounts.</p> <p>This category includes stock information (but not stock trading), home finance, and government-related financial information.</p>
For Kids	<p>Web pages that are family-safe, specifically for children of approximate ages ten and under.</p> <p>This category can also be used as an exception to allow web pages that do not pose a risk to children, or to access sites that have a primary educational or recreational focus for children, but are in other categories such as Games, Humor/Comics, Recreation/Hobbies, or Entertainment.</p>
Forum Bulletin Boards	<p>Web pages that provide access (http://) to Usenet newsgroups or hold discussions and post user-generated content, such as real-time message posting for an interest group. This category also includes archives of files uploaded to newsgroups.</p> <p>This category does not include message forums with a business or technical support focus.</p>
Gambling	<p>Web pages that allow users to wager or place bets online, or provide gambling software that allows online betting, such as casino games, betting pools, sports betting, and lotteries.</p> <p>This category does not include web pages related to gambling that do not allow betting online.</p>

Table 151 Managed Category Descriptions (continued)

CATEGORY	DESCRIPTION
Gambling Related	<p>Web pages that offer information about gambling, without providing the means to gamble.</p> <p>This category includes casino-related web pages that do not offer online gambling, gambling links, tips, sports picks, lottery results, and horse, car, or boat racing.</p>
Game Cartoon Violence	<p>Web pages that provide fantasy or fictitious representations of violence within the context of games, comics, cartoons, or graphic novels.</p> <p>This category includes images and textual descriptions of physical assaults or hand-to-hand combat, and grave injury and destruction caused by weapons or explosives.</p>
Games	<p>Web pages that offer online games and related information such as cheats, codes, demos, emulators, online contests or role-playing games, gaming clans, game manufacturer sites, fantasy or virtual sports leagues, and other gaming sites without chances of profit.</p> <p>This category includes gaming consoles.</p>
General News	<p>Web pages that provide online news media, such as international or regional news broadcasting and publication.</p> <p>This category includes portal sites that provide news content.</p>
Government Military	<p>Web pages that contain content maintained by governmental or military organizations, such as government branches or agencies, police departments, fire departments, civil defense, counter-terrorism organizations, or supranational organizations, such as the United Nations or the European Union.</p> <p>This category includes military and veterans' medical facilities.</p>
Gruesome Content	<p>Web pages with content that can be considered tasteless, gross, shocking, or gruesome.</p> <p>This category does not include web pages with content pertaining to physical assault.</p>
Health	<p>Web pages that cover all health-related information and health care services.</p> <p>This category does not include cosmetic surgery, marketing/selling pharmaceuticals, or animal-related medical services.</p>
Historical Revisionism	<p>Web pages that denounce, or offer different interpretations of, significant historical facts, such as holocaust denial.</p> <p>This category does not include all re-examination of historical facts, only historical events that are highly sensitive.</p>
History	<p>Web pages that provide content about historical facts.</p> <p>This category includes content suitable for higher education, but the Education category includes content for primary education. For example, a site with Holocaust photographs might be offensive, but have academic value.</p>
Humor Comics	<p>Web pages that provide comical or funny content.</p> <p>This category includes sites with jokes, sketches, comics, and satire pages. This category might also include graphic novel content, which is often associated with comics.</p>
Illegal UK	<p>Web pages that contain child sexual abuse content hosted anywhere in the world, and criminally obscene and incitement to racial hatred content hosted in the UK.</p>

Table 151 Managed Category Descriptions (continued)

CATEGORY	DESCRIPTION
Incidental Nudity	<p>Web pages that contain non-pornographic images of the bare human body like those in classic sculpture and paintings, or medical images.</p> <p>This category enables you to allow or block sites in order to address cultural or geographic differences in opinion about nudity. For example, you can use this category to block access to nudity, but allow access when nudity is not the primary focus of a site, such as news sites or major portals.</p>
Information Security	<p>Web pages that legitimately provide information about data protection. This category includes detailed information for safeguarding business or personal data, intellectual property, privacy, and infrastructure on the Internet, private networks, or in other bandwidth services such as telecommunications.</p> <p>This category does not include:</p> <ul style="list-style-type: none"> • Legitimate information security companies and security software providers, such as virus protection companies. • Sites that intend to exploit security or teach how to bypass security.
Information Security New	<p>Web pages that legitimately provide information about data protection. This category includes detailed information for safeguarding business or personal data, intellectual property, privacy, and infrastructure on the Internet, private networks, or in other bandwidth services such as telecommunications.</p> <p>This category does not include:</p> <ul style="list-style-type: none"> • Legitimate information security companies and security software providers, such as virus protection companies. • Sites that intend to exploit security or teach how to bypass security.
Instant Messaging	<p>Web pages that provide software for real-time communication over a network exclusively for users who joined a member's contact list or an instant-messaging session.</p> <p>Most instant-messaging software includes features such as file transfer, PC-to-PC phone calls, and can track when other people log on and off.</p>
Interactive Web Applications	<p>Web pages that provide access to live or interactive web applications, such as browser-based office suites and groupware. This category includes sites with business, academic, or individual focus.</p> <p>This category does not include sites providing access to interactive web applications that do not take critical user data or offer security risks, such as Google Maps.</p>
Internet Radio TV	<p>Web pages that provide software or access to continuous audio or video broadcasting, such as Internet radio, TV programming, or podcasting.</p> <p>Quick downloads and shorter streams that consume less bandwidth are in the Streaming Media or Media Downloads categories.</p>
Internet Services	<p>Web pages that provide services for publication and maintenance of Internet sites such as web design, domain registration, Internet Service Providers, and broadband and telecommunications companies that provide web services.</p> <p>This category includes web utilities such as statistics and access logs, and web graphics like clip art.</p>
Job Search	<p>Web pages related to a job search including sites concerned with resume writing, interviewing, changing careers, classified advertising, and large job databases. This category also includes corporate web pages that list job openings, salary comparison sites, temporary employment, and company job-posting sites.</p> <p>This category does not include make-money-at-home sites.</p>

Table 151 Managed Category Descriptions (continued)

CATEGORY	DESCRIPTION
Major Global Religions	<p>Web pages with content about religious topics and information related to major religions. This category includes sites that cover religious content such as discussion, beliefs, non-controversial commentary, articles, and information for local congregations such as a church or synagogue homepage.</p> <p>The religions in this category are Baha'i, Buddhism, Chinese Traditional, Christianity, Hinduism, Islam, Jainism, Judaism, Shinto, Sikhism, Tenrikyo, Zoroastrianism.</p>
Marketing Merchandising	<p>Web pages that promote individual or business products or services on the web, but do not sell their products or services online.</p> <p>This category includes websites that are generally a company overview, describing services or products that cannot be purchased directly from these sites. Examples include automobile manufacturer sites, wedding photography services, or graphic design services.</p> <p>This category does not include:</p> <ul style="list-style-type: none"> • Other categories that imply marketing such as Alcohol, Auctions/Classifieds, Drugs, Finance/Banking, Mobile Phone, Online Shopping, Real Estate, School Cheating Information, Software/Hardware, Stock Trading, Tobacco, Travel, and Weapons. • Sites that market their services only to other businesses. See the Business category. • Sites that rob or cheat consumers. See the Consumer Protection category.
Media Downloads	<p>Web pages that provide audio or video files for download such as MP3, WAV, AVI, and MPEG formats. The files are saved to, and played from, the user's computer.</p> <p>This category does not include audio or video files that are played directly through a browser window. See the Streaming Media category.</p>
Media Sharing	<p>Web pages that allow users to upload, search for, and share media files and photographs, such as online photograph albums.</p>
Messaging	<p>Examples include text messaging to mobile phones, PDAs, fax machines, and internal website user-to-user messaging or site-to-site messaging.</p> <p>This category does not include real-time chat or instant messaging, or message posts that can be viewed by anyone but the intended recipient.</p>
Mobile Phone	<p>Web pages that sell media, software, or utilities for mobile phones that can be downloaded and delivered to mobile phones.</p> <p>Examples include ringtones, logos/skins, games, screen-savers, text-based tunes, and software for SMS, MMS, WAP, and other mobile phone protocols.</p>
Moderated	<p>Bulletin boards, chat rooms, search engines, or web mail sites that are monitored by an individual or group who has the authority to block messages or content considered inappropriate.</p> <p>This category does not include sites with posted rules against offensive content. See the Forum/Bulletin Boards category.</p>
Motor Vehicles	<p>Websites for manufacturers and dealerships of consumer transportation vehicles, such as cars, vans, trucks, SUVs, motorcycles, and scooters. This category also includes sites that provide product marketing, reviews, comparisons, pricing information, auto fairs, auto expos, and general consumer information about motor vehicles.</p> <p>This category does not include automotive accessories, mechanics, auto-body shops, and recreational hobby pages. This category does not include sites that provide business-to-business-only content regarding motor vehicles.</p>
Non Profit Advocacy NGO	<p>Web pages from charitable or educational groups that fulfill a stated mission, benefiting the larger community, such as clubs, lobbies, communities, non-profit organizations, labor unions, and advocacy groups.</p> <p>Examples are Masons, Elks, Boy and Girl Scouts, or Big Brothers.</p>

Table 151 Managed Category Descriptions (continued)

CATEGORY	DESCRIPTION
Nudity	<p>Web pages that have non-pornographic images of the bare human body. This category includes classic sculpture and paintings, artistic nude photographs, some naturism pictures, and detailed medical illustrations.</p> <p>This category does not include high-profile sites where nudity is not a concern for visitors. See the Incidental Nudity category.</p>
Online Shopping	<p>Web pages that sell products or services online.</p> <p>Web pages selling a broad range of products might pose a risk to users by offering access to items that are normally in other categories such as Pornography, Weapons, Nudity, or Violence. Web pages selling such content exclusively are in their respective categories.</p>
P2P File Sharing	<p>Web pages that allow the exchange of files between computers and users for business or personal use, such as downloadable music.</p> <p>P2P clients allow users to search for and exchange files from a peer-user network. They often include spyware or real-time chat capabilities. This category includes BitTorrent web pages.</p>
Parked Domain	<p>Web pages that once served content, but their domains have been sold or abandoned and are no longer registered.</p> <p>Parked domains do not host their own content, but usually redirect users to a generic page that states the domain name is for sale, or redirect users to a generic search engine and portal page, some of which provide valid search engine results.</p>
Personal Network Storage	<p>Web pages that allow users to upload folders and files to an online network server in order to backup, share, edit, or retrieve files or folders from any web browser.</p>
Personal Pages	<p>Personal home pages that share a common domain such as those hosted by ISPs, university/education servers, or free web page hosts.</p> <p>This category also includes unique domains that contain personal information, such as a personal home page. This category does not include home pages of public figures.</p>
Pharmacy	<p>Web pages that provide reviews, descriptions, and market or sell prescription-based drugs, over-the-counter drugs, birth control, or dietary supplements.</p>
Politics Opinion	<p>Web pages covering political parties, individuals in political life, and opinion on various topics.</p> <p>This category might also cover laws and political opinion about drugs. This category includes URLs for political parties, political campaigning, and opinions on various topics, including political debates.</p>
Pornography	<p>Web pages that contain materials intended to be sexually arousing or erotic.</p> <p>This category includes fetish pages, animation, cartoons, stories, and illegal pornography.</p>
Portal Sites	<p>Web pages that serve as major gateways or directories to content on the web.</p> <p>Many portal sites also provide a variety of internal site features or services such as search engines, email, news, and entertainment. Mailing list sites with a variety of content are in this category.</p> <p>This category does not include sites with topic-specific content.</p>
Potential Criminal Activities	<p>Web pages that provide instructions to commit illegal or criminal activities.</p> <p>Instructions include committing murder or suicide, sabotage, bomb-making, lock-picking, service theft, evading law enforcement, or spoofing drug tests. This category might also include information on how to distribute illegal content, perpetrate fraud, or consumer scams.</p> <p>This category does not include computer-related fraud.</p>

Table 151 Managed Category Descriptions (continued)

CATEGORY	DESCRIPTION
Potential Hacking Computer Crime	<p>Web pages that provide instructions, or otherwise enable, fraud, crime, or malicious activity that is computer-oriented.</p> <p>This category includes web pages related to computer crime include malicious hacking information or tools that help individuals gain unauthorized access to computers and networks (root kits, kiddie scripts). This category also includes other areas of electronic fraud such as dialer scams and illegal manipulation of electronic devices.</p> <p>This category does not include illegal software.</p>
Potential Illegal Software	<p>Web pages, which the filter believes offer information to potentially 'pirated' or illegally distribute software or electronic media, such as copyrighted music or film, distribution of illegal license key generators, software cracks, and serial numbers.</p> <p>This category does not include peer-to-peer web pages.</p>
Private IP Addresses	<p>Sites that are private IP addresses as defined in RFC 1918, that is, hosts that do not require access to hosts in other enterprises (or require just limited access) and whose IP address may be ambiguous between enterprises but are well defined within a certain enterprise.</p>
Profanity	<p>Web pages that contain crude, vulgar, or obscene language or gestures.</p>
Professional Networking	<p>Web pages that provide social networking exclusively for professional or business purposes.</p> <p>This category includes sites that provide personal or group profiles, and enable their members to interact through real-time communication, message posting, public bulletins, and media sharing. This category also contains alumni sites that have a networking function.</p> <p>This category does not include social networking sites where the focus might vary, but include friendship, dating, or professional focuses.</p>
Provocative Attire	<p>Web pages with pictures that include alluring or revealing attire, lingerie and swimsuits, or supermodel or celebrity photograph collections, but do not involve nudity.</p> <p>This category does not include sites with swimwear or similar attire that is not intended to be provocative. For example, Olympic swimming sites are not in this category.</p>
Public Information	<p>Web pages that provide general reference information such as public service providers, regional information, transportation schedules, maps, or weather reports.</p>
PUPs	<p>Web pages that contain Potentially Unwanted Programs (PUPs).</p> <p>PUPs are often made for a beneficial purpose but they alter the security of a computer or the computer user's privacy. Computer users who are concerned about security or privacy might want to be informed about this software, and in some cases, they might want to remove this software from their computers.</p>
Real Estate	<p>Web pages that provide commercial or residential real estate services and information.</p> <p>Service and information includes sales and rental of living space or retail space and guides for apartments, housing, and property, and information on appraisal and brokerage. This category includes sites that allow you to browse model homes.</p> <p>This category does not include content related to personal finance, such as credit applications.</p>

Table 151 Managed Category Descriptions (continued)

CATEGORY	DESCRIPTION
Recreation Hobbies	<p>Web pages for recreational organizations and facilities that include content devoted to recreational activities and hobbies.</p> <p>This category includes information about public swimming pools, zoos, fairs, festivals, amusement parks, recreation guides, hiking, fishing, bird watching, or stamp collecting.</p> <p>This category does not include activities that need no active participation, such as watching a movie or reading celebrity gossip.</p>
Religion Ideology	<p>Web pages with content related to religious topics and beliefs in human spirituality that are not within the major religions.</p> <p>This category includes religious discussion, beliefs, articles, and information for local congregations or groups such as a church homepage, unless the site is already in the Major Global Religions category. This category also includes comparative religion, or sites that include religions and ideologies.</p> <p>This category does not include astrology and horoscope sites</p>
Remote Access	<p>Web pages that provide remote access to a program, online service, or an entire computer system.</p> <p>Although remote access is often used legitimately to run a computer from a remote location, it creates a security risk, such as backdoor access. Backdoor access, written by the original programmer, allows the system to be controlled by another party without the user's knowledge.</p>
Reserved	This category is reserved for future use.
Residential IP Addresses	<p>IP addresses (and any domains associated with them) that access the Internet by DSL modems or cable modems.</p> <p>Because this content is not generally intended for Internet access via HTTP, access to the Internet through these IP addresses can indicate suspicious behavior. This behavior might be related to malware located on the home computer or homegrown gateways set up to allow anonymous Internet access.</p>
Resource Sharing	<p>Web pages that harness idle or unused computer resources to focus on a common task.</p> <p>The task can be on a company or an international basis. Well known examples are the SETI program and the Human Genome Project, which use the idle time of thousands of volunteered computers to analyze data.</p>
Restaurants	<p>Web pages that provide information about restaurants, bars, catering, take-out and delivery, including online ordering.</p> <p>This category includes sites that provide information about location, hours, prices, menus and related dietary information. This category also includes restaurant guides and reviews, and cafes and coffee shops.</p> <p>This category does not include groceries, wholesale food, non-profit and charitable food organizations, or bars that do not focus on serving food.</p>
School Cheating Information	<p>Web pages that promote plagiarism or cheating by providing free or fee-based term papers, written essays, or exam answers.</p> <p>This category does not include sites that offer student help, discuss literature, films, or books, or other content that is often the subject of research papers.</p>
Search Engines	<p>Web pages that provide search results that enable users to find information on the Internet based on key words.</p> <p>This category does not include site-specific search engines.</p>

Table 151 Managed Category Descriptions (continued)

CATEGORY	DESCRIPTION
Sexual Materials	<p>Web pages that describe or depict sexual acts, but are not intended to be arousing or erotic.</p> <p>Examples of sexual materials include sex education, sexual innuendo, humor, or sex related merchandise.</p> <p>This category does not include web pages with content intended to arouse.</p>
Shareware Freeware	<p>Web pages that are repositories of downloadable copies of shareware and freeware.</p> <p>This category does not include subscription-based software.</p>
Social Networking	<p>Web pages that enable social networking for a variety of purposes, such as friendship, dating, professional, or topics of interest.</p> <p>These sites provide personal or group profiles and enable interaction among their members through real-time communication, message posting, public bulletins, and media sharing.</p> <p>This category does not include sites that are exclusive to dating, matchmaking, or a specific professional networking focus.</p>
Software Hardware	<p>Web pages related to computing software and hardware, including vendors, product marketing and reviews, deployment and maintenance of software and hardware, and software updates and add-ons such as scripts, plug-ins, or drivers. Hardware includes computer parts, accessories, and electronic equipment used with computers and networks.</p> <p>This category includes the marketing of software and hardware, and magazines focused on software or hardware product reviews or industry trends.</p>
Sports	<p>Web pages related to professional or organized recreational sports.</p> <p>This category includes sporting news, events, and information such as playing tips, strategies, game scores, or player trades.</p> <p>This category does not include fantasy leagues, sports centers, athletic clubs, fitness or martial arts clubs, and non-league billiards, darts, or other such activities.</p>
Stock Trading	<p>Web pages that offer purchasing, selling, or trading of shares online.</p> <p>This category also includes ticker-tape information that enables viewing of real-time stock prices and financial spread betting in the stock market. Other betting is in the Gambling category.</p> <p>This category does not include sites that offer information about stocks, but do not offer purchasing, selling, or trading of shares.</p>
Streaming Media	<p>Web pages that provide streaming media, or contain software plug-ins for displaying audio and visual data before the entire file has been transmitted.</p> <p>This category does not include audio or video files that are downloaded to a user's computer before being played.</p>
Technical Business Forums	<p>Web pages with a technical or business focus that provide online message posting or real-time chatting, such as technical support or interactive business communication.</p> <p>Although users can post any type of content, these forums tend to present less risk of containing offensive content.</p> <p>Sites that offer a variety of forums with themes, including technical and business content, are only in the categories of Forum/Bulletin Boards or Chat.</p>

Table 151 Managed Category Descriptions (continued)

CATEGORY	DESCRIPTION
Technical Information	<p>Web pages that provide computing information with an educational focus in areas such as Information Technology, computer programming, and certification.</p> <p>Examples include Linux user groups, UNIX commands, software tutorials, or dictionaries of technical terms. Most sites in this category might be subdirectories of larger domains. For example, a software site with a tutorial page is in this category only at the tutorial page URL.</p> <p>This category does not include content about information security.</p>
Text Spoken Only	<p>Content that is text or audio only, and does not contain pictures.</p> <p>This category can be used as an exception to allow explicit text and recorded material to be accessed when you want pictures blocked using the Pornography, Violence, or Sexual Materials categories. Libraries or universities can use this category to prevent the display of offensive graphics in their public facilities.</p>
Text Translators	<p>Web pages that allow users to type phrases or a block of text to translate it from one language into another.</p> <p>This category also includes language identifier web pages. URL translation is in the Anonymizing Utilities category.</p>
Tobacco	<p>Web pages that sell, promote, or advocate the use of tobacco products, tobacco paraphernalia, including cigarettes, cigars, pipes, snuff and chewing tobacco.</p>
Travel	<p>Web pages that promote personal or business travel, such as hotels, resorts, airlines, ground transportation, car rentals, travel agencies, and general tourist and travel information.</p> <p>This category also includes sites for buying tickets or accommodation.</p> <p>This category does not include personal vacation photographs.</p>
Usenet News	<p>Web pages that provide access (http://) to Usenet newsgroups and archives of files uploaded to newsgroups.</p> <p>This category also includes online groups that offer similar community-oriented content posting.</p>
Violence	<p>Web pages that contain real or lifelike images or text that portray, describe, or advocate physical assaults against people, animals, or institutions, such as depictions of war, suicide, mutilation, or dismemberment.</p>
Visual Search Engine	<p>Web pages that provide image-specific search results such as thumbnail pictures.</p> <p>This category does not include sites that offer site-specific visual search engines.</p>
Weapons	<p>Web pages that provide information about buying, making, modifying, or using weapons, such as guns, knives, swords, paintball guns, and ammunition, explosives, and weapon accessories.</p> <p>This category also includes sites that contain content for: weapons for personal or military use, homemade weapons, non-lethal weapons such as mace, pepper spray, or Taser guns, weapons facilities, such as shooting ranges, and government or military oriented weapons.</p> <p>This category does not include political action groups, such as the NRA.</p>
Web Ads	<p>Web pages that provide advertisement-hosting or programs that create advertisements.</p> <p>Examples include links, source code or applets for banners, popups, and other kinds of static or dynamically generated advertisements that appear on web pages. This category is intended to block advertisements on web pages, not the companies that provide the advertisements or advertising services.</p> <p>This category does not include aggressive advertising adware. See the Spyware/ Adware category.</p>

Table 151 Managed Category Descriptions (continued)

CATEGORY	DESCRIPTION
Web Mail	Web pages that enable users to send or receive email through the Internet.
Web Meetings	Web pages that host live meetings, video conferences, and interactive presentations mainly for businesses. Web meetings generally include streaming audio and video, and allow data transfer or office-oriented application sharing, such as online presentations.
Web Phone	Web pages that enable users to make telephone calls via the Internet or obtain information or software for this purpose. Web Phone service is also called Internet Telephony, or VoIP. Web phone service includes PC-to-PC, PC-to-phone, and phone-to-phone services connecting via TCP/IP networks.
Unrated	Web pages that cannot be categorized into the categories listed above.

17.2.2 Content Filtering Profile (Allow List)

Click **Security Service > Content Filtering > Add/Edit** to open the profile screen and scroll to the **Allow List** part. You can create a common list of good (allowed) web site addresses. Use this part of screen to add or remove specific sites from the filter list.

Figure 198 Security Service > Content Filter > Add/Edit Profile (Allow List)

Allow List

Allow HTTP(S) traffic for allow lists only ?

Log no

+ Add Remove

Name
No data





Note
Use "*" as a wildcard to match any string in allow/block lists and blocked URL keywords (for example, *.zyxel*.com).

The following table describes the labels in this part of the screen.

Table 152 Security Service > Content Filter > Add/Edit Profile (Allow List)

LABEL	DESCRIPTION
Allow HTTP(S) traffic for allow lists only	Select this to have the Zyxel Device only allow access to the web sites listed in the allow list.
Log	A log at the alert level is a log for serious events that may need more immediate attention. For example, you may want to know right away if there are clients in your networks that try to access adult topics or drugs related web pages. Select log to have the Zyxel Device generate logs at the info level or select no if you don't want the Zyxel Device to generate logs.
Add	Click this to create a new entry.
Edit	Select an entry and click this to be able to modify it.
Remove	Select an entry and click this to delete it.

Table 152 Security Service > Content Filter > Add/Edit Profile (Allow List) (continued)

LABEL	DESCRIPTION
Name	This column displays the trusted web sites already added. Enter host names such as www.good-site.com into this text field. Do not enter the complete URL of the site – that is, do not include "http://". All subdomains are allowed. For example, entering "zyxel.com" also allows "www.zyxel.com", "partner.zyxel.com", "press.zyxel.com", and so on. You can also enter just a top level domain. For example, enter .com to allow all .com domains. Use up to 127 characters (0-9a-z). The casing does not matter. "*" can be used as a wildcard to match any string. The entry must contain at least one "." or it will be invalid.
Edit	Select an entry and click this icon to modify it. 
Remove	Select an entry and click this icon to delete it. 
Save Changes	Click this icon to save the changes in this row. 
Cancel Changes	Click this icon to cancel the changes in this row. 

17.2.3 Content Filtering Profile (Block List)

Click **Security Service > Content Filtering > Add/Edit** to open the profile screen and scroll to the **Block List** part. You can create a common list of bad (blocked) web site addresses. Use this part of the screen to add or remove specific sites from the filtering list.

Figure 199 Security Service > Content Filtering > Add/Edit Profile (Block List)

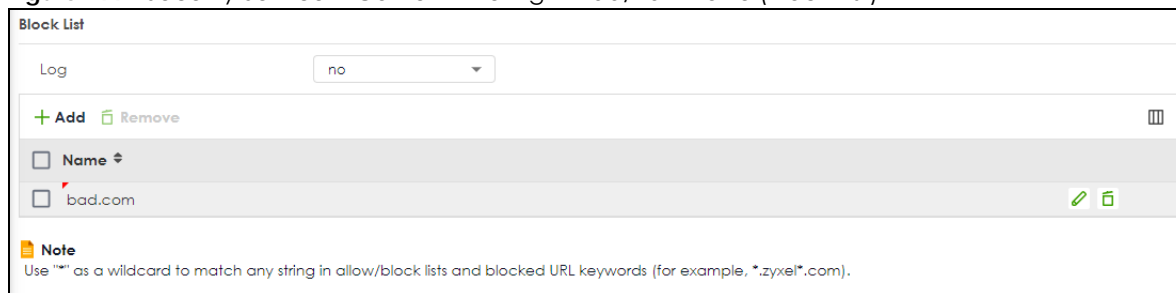





The following table describes the labels in this screen.

Table 153 Security Service > Content Filtering > Add/Edit Profile (Block List)

LABEL	DESCRIPTION
Log	A log at the alert level is a log for serious events that may need more immediate attention. For example, you may want to know right away if there are clients in your networks that try to access adult topics or drugs related web pages. Select log to have the Zyxel Device generate logs at the info level or select log alert to have the Zyxel Device generate logs at the alert level. Select no if you don't want the Zyxel Device to generate logs.
Add	Click this to create a new entry.
Edit	Select an entry and click this to be able to modify it.

Table 153 Security Service > Content Filtering > Add/Edit Profile (Block List) (continued)

LABEL	DESCRIPTION
Remove	Select an entry and click this to delete it.
Name	<p>This list displays the forbidden web sites already added.</p> <p>Enter host names such as www.bad-site.com into this text field. Do not enter the complete URL of the site – that is, do not include “http://”. All subdomains are also blocked. For example, entering “bad-site.com” also blocks “www.bad-site.com”, “partner.bad-site.com”, “press.bad-site.com”, and do on. You can also enter just a top level domain. For example, enter .com to block all .com domains.</p> <p>Use up to 127 characters (0-9a-z-). The casing does not matter. “*” can be used as a wildcard to match any string. The entry must contain at least one “.” or it will be invalid.</p>
Edit	<p>Select an entry and click this icon to modify it.</p> 
Remove	<p>Select an entry and click this icon to delete it.</p> 
Save Changes	<p>Click this icon to save the changes in this row.</p> 
Cancel Changes	<p>Click this icon to cancel the changes in this row.</p> 

17.2.4 Content Filtering Profile (Blocked URL Keywords)





Click **Security Service > Content Filtering > Add/Edit** to open the profile screen and scroll to the **Blocked URL keywords** part. You can create a common list of bad (blocked) URL keywords to block web sites with URLs that contain certain keywords in the domain name or IP address. Use this part of the screen to add or remove specific URL keywords from the filter list.

Figure 200 Security Service > Content Filtering > Add/Edit Profile (Blocked URL Keywords)



The following table describes the labels in this part of the screen.

Table 154 Security Service > Content Filtering > Add/Edit Profile (Blocked URL Keywords)

LABEL	DESCRIPTION
Log	<p>A log at the alert level is a log for serious events that may need more immediate attention. For example, you may want to know right away if there are clients in your networks that try to access adult topics or drugs related web pages.</p> <p>Select log to have the Zyxel Device generate logs at the info level or select log alert to have the Zyxel Device generate logs at the alert level.</p> <p>Select no if you don't want the Zyxel Device to generate logs.</p>
Add	Click this to create a new entry.
Edit	Select an entry and click this to be able to modify it.
Remove	Select an entry and click this to delete it.
Name	<p>This list displays the forbidden keywords already added.</p> <p>Enter a keyword or a numerical IP address to block. You can also enter a numerical IP address.</p> <p>Use up to 127 case-sensitive characters (0-9a-zA-Z;/?:@&+=\$\._!~*()%). "*" can be used as a wildcard to match any string. Use " " to indicate a single wildcard character.</p> <p>For example, enter *Bad_Site* to block access to any web page that includes the exact phrase (Bad_Site). This does not block access to web pages that only include part of the phrase (such as Bad for example).</p> <p>Please note that the Zyxel Device checks the URL's domain name (or IP address) and file path separately when performing keyword blocking; see Section 17.1.2 on page 293 for more information.</p> <p>When the Zyxel Device inspects URL queries made by users on your network, the Zyxel Device will check both the URL domain name and file path for keywords that are blocked.</p> <p>Note: When the Zyxel Device inspects DNS queries made by users on your network, the Zyxel Device will only check URL domain name for keywords that are blocked, but not the file path.</p>
Edit	<p>Select an entry and click this icon to modify it.</p> 
Remove	<p>Select an entry and click this icon to delete it.</p> 
Save Changes	<p>Click this icon to save the changes in this row.</p> 
Cancel Changes	<p>Click this icon to cancel the changes in this row.</p> 

17.2.5 Content Filtering Profile (Test Web Site Category)

Click **Security Service > Content Filter > Add/Edit** to open the profile screen and scroll to the **Test Web Site Category** part. Use this part of the screen to check which category a web page belongs to.

Figure 201 Security Service > Content Filtering > Add/Edit Profile (Test Web Site Category)

The following table describes the labels in this part of the screen.

Table 155 Security Service > Content Filtering > Add/Edit Profile (Test Web Site Category)

LABEL	DESCRIPTION
Test Web Site Category	
URL to test	Enter a web site URL in the text box. When content filtering is active, you should see the web page's category. The query fails if content filtering is not active. Content Filtering can query a category by full URL string (for example, http://www.google.com/picture/index.html), but HTTPS domain filter can only query a category by domain name (www.google.com), so the category may be different in the query result. URL to test displays both results in the test.
If you think the category is incorrect, click this link to submit a request to review it.	Click this link to see the category recorded in the Zyxel Device's content filtering database for the web page you specified (if the database has an entry for it).
Apply	Click Apply to save your screen changes back to the Zyxel Device.
Cancel	Click Cancel to return the screen to its last-saved settings.

17.3 Content Filtering Example: Block LAN Users

This example shows you how to block LAN users from using a remote WAN application such as TeamViewer.

Client **C1** on the Zyxel Device LAN uses computer **A**. Client **C2** on the WAN uses computer **B**. Computer **A** and computer **B** are connected to the TeamViewer server (**S**). Client **C1** could access computer **B** using TeamViewer. Client **C2** could access computer **A** using TeamViewer. TeamViewer only works if computer **A** and computer **B** are both connected to the TeamViewer server (**S**).

Figure 202 Content Filter Tutorial Example

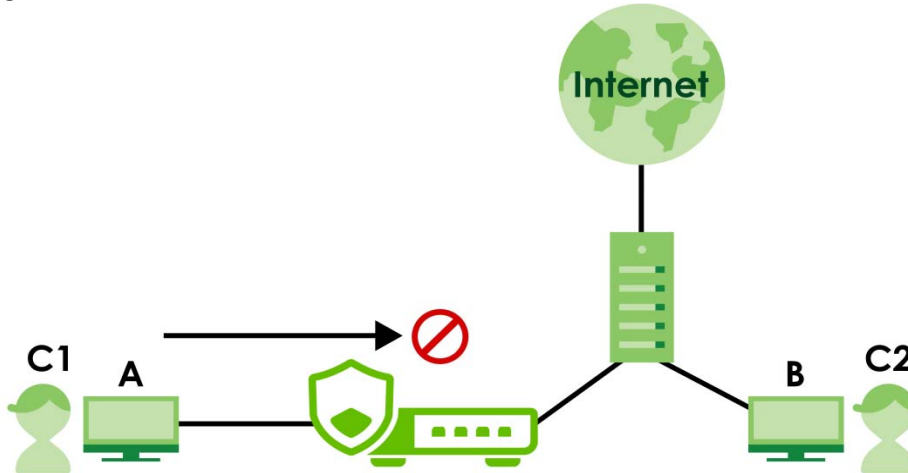

You want to block all LAN clients from using TeamViewer. Create a **Content Filtering** profile that includes the remote access category. Create a **Content Filtering** block list rule with TeamViewer as the keyword. Then apply the profile to the **LAN_Outgoing** security policy.

All LAN clients are now blocked from using TeamViewer.

This example uses the parameters listed below.

Table 156 Content Filtering Profile Configuration Example

PROFILE NAME	ACTION	LOG	MANAGED CATEGORIES
NoRemoteAccess	Block	Log Alert	Remote Access

Table 157 Block List Configuration Example

LOG	BLOCK LIST KEYWORD
Log Alert	*.teamviewer.*

Table 158 Security Policy Configuration Example

TO	FROM	LOG	CONTENT FILTERING PROFILE
WAN	LAN	By Profile	NoRemoteAccess

- 1 Go to **Security Service > Content Filtering** and click **Add**.
- 2 Configure the profile settings using the parameters given in [Table 156 on page 316](#).

General Settings

Name: NoRemoteAccess

Description: [Empty text box]

Action: block

Log: log alert

Log allowed traffic:

SSL V3 or previous version Connection: Drop

Drop Log: no

3 Select the **Remote Access** checkbox under **Managed Categories**.

Managed Categories

Select All Categories Clear All Categories

<input type="checkbox"/> Adult Topics	<input type="checkbox"/> Alcohol	<input type="checkbox"/> Anonymizing Utilities	<input type="checkbox"/> Art Culture Heritage
<input type="checkbox"/> Auctions Classifieds	<input type="checkbox"/> Blogs/Wiki	<input type="checkbox"/> Business	<input type="checkbox"/> Chat
<input type="checkbox"/> Computing Internet	<input type="checkbox"/> Consumer Protection	<input type="checkbox"/> Content Server	<input type="checkbox"/> Controversial Opinions
<input type="checkbox"/> Cult Occult	<input type="checkbox"/> Dating Personals	<input type="checkbox"/> Dating Social Networking	<input type="checkbox"/> Digital Postcards
<input type="checkbox"/> Discrimination	<input type="checkbox"/> Drugs	<input type="checkbox"/> Education Reference	<input type="checkbox"/> Entertainment
<input type="checkbox"/> Extreme	<input type="checkbox"/> Fashion Beauty	<input type="checkbox"/> Finance Banking	<input type="checkbox"/> For Kids
<input type="checkbox"/> Forum Bulletin Boards	<input type="checkbox"/> Gambling	<input type="checkbox"/> Gambling Related	<input type="checkbox"/> Game Cartoon Violence
<input type="checkbox"/> Games	<input type="checkbox"/> General News	<input type="checkbox"/> Government Military	<input type="checkbox"/> Grossome Content
<input type="checkbox"/> Health	<input type="checkbox"/> Historical Revisionism	<input type="checkbox"/> History	<input type="checkbox"/> Humor Comics
<input type="checkbox"/> Illegal UK	<input type="checkbox"/> Incidental Nudity	<input type="checkbox"/> Information Security	<input type="checkbox"/> Information Security New
<input type="checkbox"/> Instant Messaging	<input type="checkbox"/> Interactive Web Applications	<input type="checkbox"/> Internet Radio TV	<input type="checkbox"/> Internet Services
<input type="checkbox"/> Job Search	<input type="checkbox"/> Major Global Religions	<input type="checkbox"/> Marketing Merchandising	<input type="checkbox"/> Media Downloads
<input type="checkbox"/> Media Sharing	<input type="checkbox"/> Messaging	<input type="checkbox"/> Mobile Phone	<input type="checkbox"/> Moderated
<input type="checkbox"/> Motor Vehicles	<input type="checkbox"/> Non Profit Advocacy NGO	<input type="checkbox"/> Nudity	<input type="checkbox"/> Online Shopping
<input type="checkbox"/> P2P File Sharing	<input type="checkbox"/> PUPs	<input type="checkbox"/> Parked Domain	<input type="checkbox"/> Personal Network Storage
<input type="checkbox"/> Personal Pages	<input type="checkbox"/> Pharmacy	<input type="checkbox"/> Politics Opinion	<input type="checkbox"/> Pornography
<input type="checkbox"/> Portal Sites	<input type="checkbox"/> Potential Criminal Activities	<input type="checkbox"/> Potential Hacking Computer Crime	<input type="checkbox"/> Potential Illegal Software
<input type="checkbox"/> Private IP Addresses	<input type="checkbox"/> Profanity	<input type="checkbox"/> Professional Networking	<input type="checkbox"/> Provocative Attire
<input type="checkbox"/> Public Information	<input type="checkbox"/> Real Estate	<input type="checkbox"/> Recreation Hobbies	<input type="checkbox"/> Religion Ideology
<input checked="" type="checkbox"/> Remote Access	<input type="checkbox"/> Reserved	<input type="checkbox"/> Residential IP Addresses	<input type="checkbox"/> Resource Sharing

Some changes were made
What do you want to do then?
Cancel Apply

4 Set the block list log action to **log alert**.

5 Click **Add** to add a block list rule using the parameters given in [Table 157](#) on page 316.

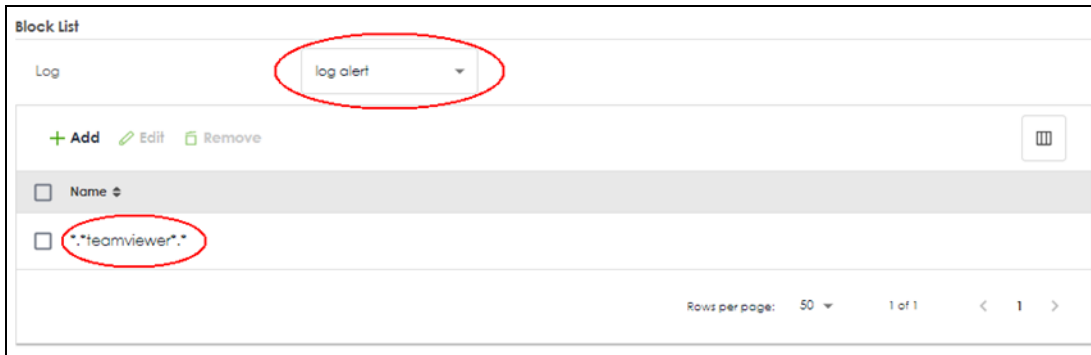

- 6 Click **Apply** to save your changes.
- 7 Go to **Security Policy > Policy Control**. Select **LAN_Outgoing** then click **Edit**.

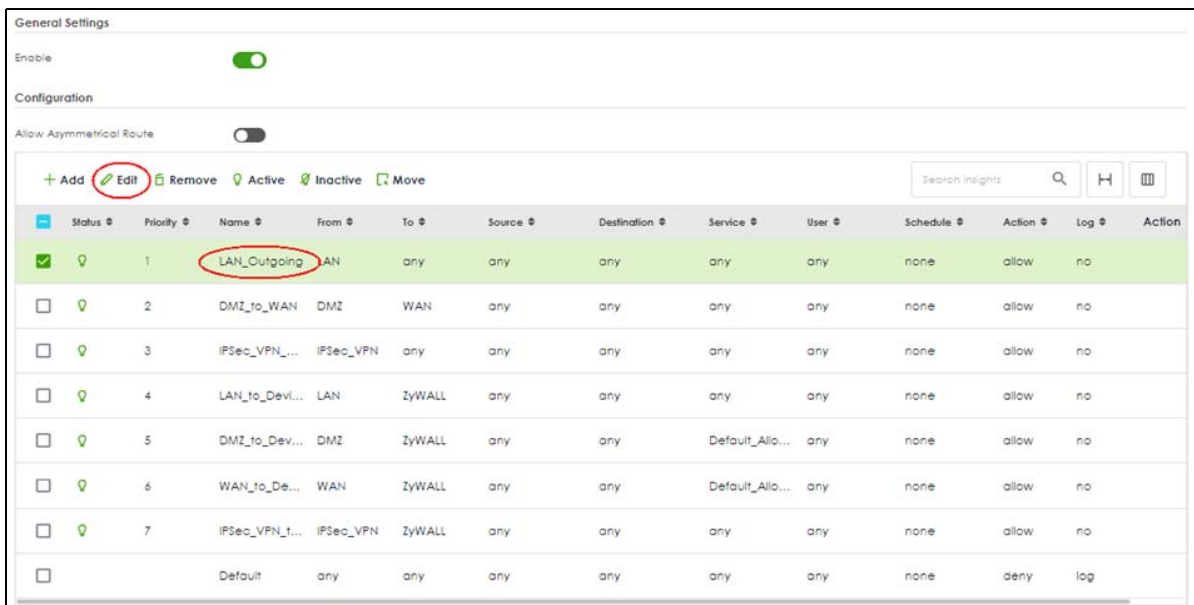

- 8 Set **Content Filter** to **NoRemoteAccess** and **Log** to **by profile**. Click **Apply** to save your changes.

Configuration

Enable

Name LAN_Outgoing

Description

From LAN 

To any 

Source any 

Destination any 

Service any 

User any 

Schedule none 

Action allow ▼

Log no ▼

Profile

Application Patrol	none ▼	Log	by profile ▼
Content Filter	NoRemoteAccess ▼	Log	by profile ▼
SSL Inspection	none ▼	Log	by profile ▼

Some changes were made
What do you want to do then?

- 9 You can check the result in the **Policy Control** screen. Mouse-over the icon under the **Action** column to check that the **NoRemoteAccess** profile has been applied to the **LAN_Outgoing** security policy. You can also check the logs in **Log & Report > Log / Events**. The Zyxel Device will create logs if the clients on the Zyxel Device LAN try to access TeamViewer.

General Settings

Enable

Configuration

Allow Asymmetrical Route

+ Add Edit Remove Active Inactive Move

Search insights

<input type="checkbox"/>	Status	Priority	Name	From	To	Source	Destinat...	Service	User	Sched...	Ac...	Log	Action
<input type="checkbox"/>	Active	1	LAN_Outgoing	LAN	any	any	any	any	any	none	allow	no	
<input type="checkbox"/>	Active	2	DMZ_to_WAN	DMZ	WAN	any	any	any	any	none	allow	no	
<input type="checkbox"/>	Active	3	IPSec_VPN_Outgoing	IPSec_VPN	any	any	any	any	any	none	allow	no	
<input type="checkbox"/>	Active	4	LAN_to_Device	LAN	ZyWALL	any	any	any	any	none	allow	no	
<input type="checkbox"/>	Active	5	DMZ_to_Device	DMZ	ZyWALL	any	any	Default...	any	none	allow	no	
<input type="checkbox"/>	Active	6	WAN_to_Device	WAN	ZyWALL	any	any	Default...	any	none	allow	no	
<input type="checkbox"/>	Active	7	IPSec_VPN_to_Device	IPSec_VPN	ZyWALL	any	any	any	any	none	allow	no	
<input type="checkbox"/>			Default	any	any	any	any	any	any	none	allow	log	

CHAPTER 18

Reputation Filter

18.1 Overview

Use the **Reputation Filter** screens to configure settings for IP Reputation, DNS Threat Filter and URL Threat filtering.

If a license has expired, you will see a reminder in this screen. You need to renew the license in order to keep using the feature. Click **Buy Now** to go to Marketplace to purchase a new license. Click **See Details** to go to the Zyxel web page to find more information on licenses for your Zyxel Device.

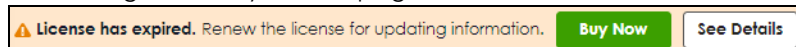

The following table shows the number of entries allowed in each screen.

Table 159 Number of Entries Allowed Comparison Table

SCREEN	NUMBER OF ENTRIES ALLOWED
IP Reputation > Allow List	256
IP Reputation > Block List	256
IP Reputation > SecuReporter Allow List	1000
DNS Threat Filter > Allow List	1024
DNS Threat Filter > Block List	1024
DNS Threat Filter > SecuReporter Allow List	1000
URL Threat Filter > Allow List	256
URL Threat Filter > Block List	256
URL Threat Filter > SecuReporter Allow List	1000

18.1.1 What You Need to Know

IP Reputation

IP reputation checks the reputation of an IP address from a database. An IP address with bad reputation associates with suspicious activities, such as spam, virus, and/or phishing. The Zyxel Device will respond when there are packets coming from an IPv4 address with bad reputation. Supported formats are:

- Single IP 4.4.4.4
- CIDR 192.168.1.0/32
- IP range (1.2.3.4-1.2.3.100)

DNS Threat Filter

DNS threat filtering inspects DNS queries made by clients on your network and compares the queries against a database of blocked or allowed Fully Qualified Domain Names (FQDNs). The Zyxel Device DNS Threat Filter will either drop the DNS query or reply to the user with a fake DNS response. URL Threat Filter

URL threat filtering compares access to specific URLs against a database of blocked or allowed sites. Sites on the database are sorted into categories such as:

• Anonymizers	• Browser Exploits	• Malicious Downloads
• Malicious Sites	• Phishing	• Spam URLs
• Spyware Adware Keyloggers		

URL Threat Filter

Supported formats are:

- hostname (www.google.com)
- URL http - check full url (http://xxx.yyy.zzz/qqq/wwww)
- URL https - only check hostname) (https://xxx.yyy.zzz/qqq/wwww)

Allow List

An allow list is a list of entries that will bypass the related feature filtering, and are permitted to pass through the Zyxel Device. You can also create allow lists in SecuReporter and view them in the Zyxel Device.

Block List

A block list is a list of entries that will bypass the related feature filtering, but are not permitted to pass through the Zyxel Device.

18.1.2 What You Can Do in this Chapter

- Use the **IP Reputation** screen ([Section 18.2 on page 322](#)) to enable IP reputation and specify what action the Zyxel Device takes when any IP address with bad reputation is detected.
- Use the **DNS Threat Filter** screen ([Section 18.3 on page 329](#)) to allow the Zyxel Device to inspect DNS queries made by clients on your network and specify what action the Zyxel Device takes when a DNS query packet contains an FQDN with a bad reputation.
- Use the **URL Threat Filter** screen ([Section 18.4 on page 334](#)) to enable URL Threat filtering and specify what action the Zyxel Device takes when any suspicious activity is detected.

18.2 IP Reputation Screen

Use this screen to enable IP reputation and specify the action the Zyxel Device takes when it detects a suspicious activity or a connection attempt to or from an IPv4 address with bad reputation.

The priority for IP Reputation checking is as follows:

- 1 Allow List
- 2 SecuReporter Allow List
- 3 Block List
- 4 External Block List
- 5 Local Zyxel Device Signatures

Click **Security Service > Reputation Filter > IP Reputation** to display the configuration screen as shown next.

Figure 203 Security Service > Reputation Filter > IP Reputation

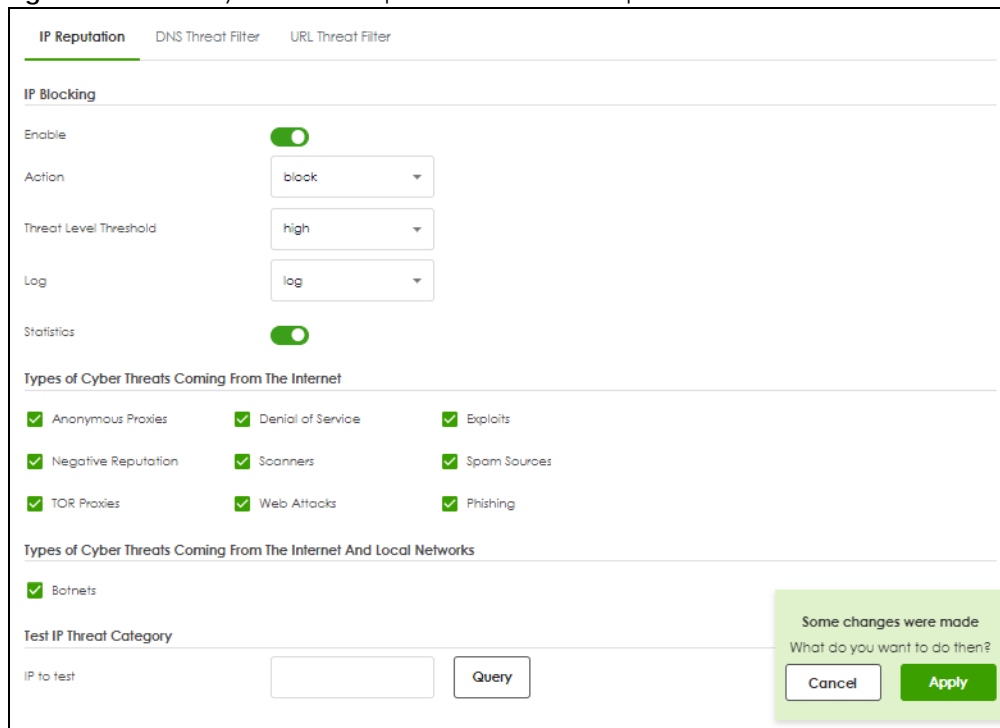

The following table describes the labels in this screen.

Table 160 Security Service > Reputation Filter > IP Reputation

LABEL	DESCRIPTION
IP Blocking	
Enable	Select this option to turn on IP blocking on the Zyxel Device. Otherwise, clear it.
Action	Set what action the Zyxel Device takes when packets come from or go to an IPv4 address with bad reputation. pass: Select this action to have the Zyxel Device allow the packet to go through. block: Select this action to have the Zyxel Device deny the packets and send a TCP RST to both the sender and receiver when a packet comes from an IPv4 address with bad reputation.

Table 160 Security Service > Reputation Filter > IP Reputation (continued)

LABEL	DESCRIPTION
Threat Level Threshold	<p>Select the threshold threat level to which the Zyxel Device will take action (high, medium and above, Low and above).</p> <p>The threat level is determined by the IP reputation engine. It grades IPv4 addresses.</p> <ul style="list-style-type: none"> • high: An IPv4 address that scores 0 to 20 points. • medium and above: An IPv4 address that scores 0-60 points. • Low and above: An IPv4 address that scores 0-80 points.
Log	<p>These are the log options:</p> <p>no: Do not create a log when the packet comes from or goes to an IPv4 address with bad reputation.</p> <p>log: Create a log on the Zyxel Device when the packet comes from or goes to an IPv4 address with bad reputation.</p> <p>log alert: An alert is an emailed log for more serious events that may need more immediate attention. Select this option to have the Zyxel Device send an alert when the packet comes from or goes to an IPv4 address with bad reputation.</p>
Statistics	<p>Enable to have the Zyxel Device collect IP reputation statistics. All of the statistics are erased if you restart the Zyxel Device or click Flush Data in Security Statistics > Reputation Filter > IP Reputation.</p>
Types of Cyber Threats Coming From The Internet	<p>Select the categories of packets that come from or go to the Internet and are known to pose a security threat to users or their computers.</p>
Anonymous Proxies	<p>These are sites and proxies that act as an intermediary for surfing to other websites in an anonymous fashion, whether to circumvent Web filtering or for other reasons.</p>
Denial of Service	<p>These are sites that issue Denial of Service (DoS) attacks, such as DoS, DDoS, SYN flood, and anomalous traffic detection.</p> <p>DoS attacks can flood your Internet connection with invalid packets and connection requests, using so much bandwidth and so many resources that Internet access becomes unavailable. The goal of DoS attacks is not to steal information, but to disable a device or network on the Internet.</p> <p>A Distributed Denial of Service (DDoS) attack is one in which multiple compromised systems attack a single target, thereby causing denial of service for users of the targeted system.</p> <p>SYN flood is an attack that attackers flood SYN packets to a server in TCP handshakes, and not respond with ACK packets on purpose. This keeps the server waiting for attackers' responses to establish TCP connections, and make the server unavailable.</p> <p>Anomalous traffic detection could be malicious activities, such as malware outbreaks or hacking attempts.</p>
Exploits	<p>These are sites that distribute exploits or exploit kits to infect website visitors' devices. Exploits include shellcode, root kits, worms, or viruses that download additional malware to infect devices. An exploit kit consists of different exploits.</p>
Negative Reputation	<p>These are sites that have bad reputation and associate with suspicious activities, such as spam, virus, and/or phishing.</p>
Scanners	<p>These are sites that run unauthorized system vulnerabilities scan to look for vulnerabilities in website visitors' devices.</p>
Spam Sources	<p>These are sites that have been promoted through spam techniques.</p>

Table 160 Security Service > Reputation Filter > IP Reputation (continued)

LABEL	DESCRIPTION
TOR Proxies	<p>These are sites that act as the exit nodes in a Tor (The Onion Router) network.</p> <p>Tor is a service that keep users anonymous in the Internet and make users' Internet activities untraceable. Tor hides user's real IP addresses by encrypting data and transmitting the encrypted data in a chain of selected nodes acting as intermediaries. Each node can only decrypt the data sent from the node before it. The first node that receives the encrypted data is called the entry node. The last node is the last intermediary that the encrypted data will go through before it arrives at the destination.</p>
Web Attacks	<p>These are sites that launch web attacks, such as SQL injection, cross site scripting, iframe injection, and brute force attack.</p> <p>SQL injection (SQLI) is an attack that attackers insert malicious SQL (Structured Query Language) code into a web application database query. Attackers can then access, add, modify, or delete data in users' databases.</p> <p>Cross site scripting (XSS) is an attack that attackers injects malicious scripts to websites or web applications in the form of HTML or JavaScript code. The scripts execute when users visit the infected web page or perform the infected web applications. XSS will cause failures to encrypt traffic, cookie stealing, identity impersonation, and phishing.</p> <p>Iframe injection is an attack that attackers injects malicious iframe (inline frame) tags to websites. The malicious iframe tag downloads malware to the devices of the infected websites' visitors, and steal users' sensitive information. An iframe tag is an HTML tag that is used to embed contents from another source in a website, but attackers misuse this feature.</p> <p>Brute force attack is an attack that attackers attempt to gain access to websites or device via a succession of different passwords.</p>
Phishing	<p>These are sites that are used for deceptive or fraudulent purposes (e.g. phishing), such as stealing financial or other user account information. These sites are most often designed to appear as legitimate sites in order to mislead users into entering their credentials.</p>
Types of Cyber Threats Coming From The Internet And Local Networks	<p>These are packets that come from or go to the Internet and local networks and are known to pose a security threat to users or their computers.</p>
Botnets	<p>A botnet is a network consisting of computers that are infected with malware and remotely controlled. The infected computers will contact and wait for instructions from a command and control (C&C) server. An attacker can control the botnet by setting up a C&C server and then sending commands to the infected computers. Alternatively, a peer-to-peer network approach is used. The infected computer scans and communicates with the peer devices in the same botnet to share commands or malware sent by the C&C server. These are botnet sites including command-and-control (C&C) servers.</p>
Test IP Threat Category	
IP to test	<p>Enter an IPv4 address of a website, and click the Query button to check if the website associates with suspicious activities that could pose a security threat to users or their computers.</p>
Apply	<p>Click Apply to save your changes.</p>
Cancel	<p>Click Cancel to return the screen to its last-saved settings.</p>

18.2.1 IP Reputation Allow List





Use this to create allow list entries. The Zyxel Device will allow packets coming from the Internet and going out from the local network that match the listed IPv4 addresses.

Click **Security Service > Reputation Filter > IP Reputation (Allow List)** to display the configuration screen as shown next.

Figure 204 Security Service > Reputation Filter > IP Reputation (Allow List)

The following table describes the labels in this part of the screen.

Table 161 Security Services > Reputation Filter > IP Reputation (Allow List)

LABEL	DESCRIPTION
Enable	Select this to bypass checking by this feature (if enabled) and automatically allow: <ul style="list-style-type: none"> incoming packets that come from the listed IPv4 addresses. outgoing packets that go to the listed IPv4 addresses.
Log	Select log if you want the Zyxel Device to create a log recording when there are incoming or outgoing packets that come from or go to the listed IPv4 addresses. Select no if you don't want the Zyxel Device to create a log.
Add	Click this to create a new entry.
Edit	Select an entry and click this to be able to modify it.
Remove	Select an entry and click this to delete it.
Active	To turn on an entry, select it and click Active .
Inactive	To turn off an entry, select it and click Inactive .
Status	The status (light bulb) icon is lit when the entry is active and dimmed when the entry is inactive.
IPv4 Address	Enter an IPv4 address that will bypass IP Reputation filtering.
Description	Enter a description for this profile.
Edit	Select an entry and click this icon to modify it. 
Remove	Select an entry and click this icon to delete it. 
Save Changes	Click this icon to save the changes in this row. 
Cancel Changes	Click this icon to cancel the changes in this row. 

18.2.2 IP Reputation Block List





Use this to create block list entries. The Zyxel Device will block packets coming from the Internet and going out from the local network that match the listed IPv4 addresses.

Click **Security Service > Reputation Filter > IP Reputation (Block List)** to display the configuration screen as shown next.

Figure 205 Security Service > Reputation Filter > IP Reputation (Block List)

The following table describes the labels in this part of the screen.

Table 162 Security Services > Reputation Filter > IP Reputation (Block List)

LABEL	DESCRIPTION
Enable	Select this to bypass checking by this feature (if enabled) and automatically block: <ul style="list-style-type: none"> incoming packets coming from the listed IPv4 addresses. outgoing packets going to the listed IPv4 addresses.
Log	Select log if you want the Zyxel Device to create a log recording when there are incoming or outgoing packets that come from or go to the listed IPv4 addresses. Select no if you don't want the Zyxel Device to create a log.
Add	Click this to create a new entry.
Edit	Select an entry and click this to be able to modify it.
Remove	Select an entry and click this to delete it.
Active	To turn on an entry, select it and click Active .
Inactive	To turn off an entry, select it and click Inactive .
Status	The activate (light bulb) icon is lit when the entry is active and dimmed when the entry is inactive.
IPv4 Address	Enter an IPv4 address that will be blocked without processing IP Reputation filtering.
Description	Enter a description for this profile.
Edit	Select an entry and click this icon to modify it. 
Remove	Select an entry and click this icon to delete it. 
Save Changes	Click this icon to save the changes in this row. 
Cancel Changes	Click this icon to cancel the changes in this row. 

18.2.3 IP Reputation SecuReporter Allow List

Use this to view SecuReporter allow list entries. To remove an items from this list, you must go to SecuReporter. The Zyxel Device will allow packets coming from the Internet and going out from the local network that match the listed IPv4 addresses.

Click **Security Service > Reputation Filter > IP Reputation (SecuReporter Allow List)** to display the configuration screen as shown next.

Figure 206 Security Service > Reputation Filter > IP Reputation (SecuReporter Allow List)

SecuReporter Allow List

IPv4 Address ▾

No data

Note
This table is read-only. If you want to remove an IP address from the SecuReporter Allow list, go to [SecuReporter](#).

SecuReporter Allow List Information

Last Sync Time	N/A
Last Update Time	N/A
Status	Status: N/A

Signature Information

Current Version	1.0.0.20190101.0
Release Date	2019-08-14 13:26:32

[Update Signatures](#)

The following table describes the labels in this screen.

Table 163 Security Services > Reputation Filter > IP Reputation (SecuReporter Allow List)

LABEL	DESCRIPTION
IPv4 Address	This read-only table displays the SecuReporter allow list entries.
SecuReporter Allow List Information	The Zyxel Device synchronizes with SecuReporter periodically (every 10 minutes at the time of writing).
Last Sync Time	This field displays the date and time the Zyxel Device last checked for new SecuReporter allow list entries.
Last Update Time	This field displays the date and time the Zyxel Device last updated SecuReporter allow list entries.
Status	This field displays the status of SecuReporter allow list entries: Success , Parse message error , HTTP error , Connection timeout and Error . If an error is received, make sure the Zyxel Device has Internet access and can connect to the SecuReporter portal.
Signature Information	The following fields display information on the current signature set that the Zyxel Device is using.
Current Version	This field displays the IP Reputation signature set version number. This number gets larger as the set is enhanced.
Release Date	This field displays the date and time the set was released.
Update Signatures	Click this link to go to the screen you can use to download signatures from the update server.
Apply	Click Apply to save your changes.
Cancel	Click Cancel to return the screen to its last-saved settings.

18.3 DNS Threat Filter Screen

A Domain Name System (DNS) server records mappings of FQDN (Fully Qualified Domain Names) to IP addresses. A FQDN consists of a host and domain name. For example, www.zyxel.com is a fully qualified domain name, where "www" is the host, "zyxel" is the second-level domain, and "com" is the top level domain.

DNS threat filtering inspects DNS queries made by clients on your network and compares the queries against a database of blocked or allowed Fully Qualified Domain Names (FQDNs).

If a user attempts to connect to a suspect site, where the DNS query packet contains an FQDN with a bad reputation, then a DNS query is sent from the user's computer and detected by the DNS Threat Filter.

The Zyxel Device DNS Threat Filter will either drop the DNS query or reply to the user with a fake DNS response using the default dnsft.cloud.zyxel.com IP address (where the user will see a "Web Page Blocked!" page) or a custom IP address.

The following types of DNS queries are allowed by the Zyxel Device:

- Type "A" for IPv4 addresses

The Zyxel Device replies with a DNS server error for the following types of DNS queries:

- Type "NS" (Name Server) to get information about the authoritative name server
- Type "MX" (Mail eXchange) to request information about the mail exchange server for a specific DNS domain name.
- Type "CNAME" (Canonical Names) that specifies a domain name that has to be queried in order to resolve the original DNS query
- Type "PTR" (Pointer) that specifies a reverse query (requesting the FQDN corresponding to the IP address you provided)
- Type "SOA" (Start Of zone Authority) used when transferring zones

The priority for DNS Threat Filter checking is as follows:

- 1 Allow List
- 2 SecuReporter Allow List
- 3 Block List
- 4 External Block List
- 5 Cloud Query Cache
- 6 Cloud Query

Click **Security Service > Reputation Filter > DNS Threat Filter** to display the configuration screen as shown next.

Figure 207 Security Service > Reputation Filter > DNS Threat Filter

The screenshot shows the 'DNS Threat Filter' configuration page. At the top, there are three tabs: 'IP Reputation', 'DNS Threat Filter' (which is selected), and 'URL Threat Filter'. Below the tabs, the 'DNS Threat Filter' section contains several settings: 'Enable' is turned on; 'Action' is set to 'redirect'; 'Log' is set to 'log'; 'Redirect IP' is set to 'default'; 'Malform DNS packets' has 'Action' set to 'drop' and 'Log' set to 'log'; 'Statistics' is turned on. The 'Security Threat Categories' section has checkboxes for 'Anonymizers', 'Browser Exploits', 'Malicious Downloads', 'Malicious Sites', 'Phishing', 'Spam URLs', and 'Spyware Adware Keyloggers', all of which are checked. The 'Test Domain Name Category' section has a text box for 'Domain name to test' and a 'Query' button. A notification box at the bottom right says 'Some changes were made' and 'What do you want to do then?' with 'Cancel' and 'Apply' buttons.

The following table describes the labels in this screen.

Table 164 Security Service > Reputation Filter > DNS Threat Filter

LABEL	DESCRIPTION
DNS Threat Filter	
Enable	Select this option to turn on DNS threat filtering on the Zyxel Device. Otherwise, clear it. Action and Log settings apply to DNS query packets triggered by the security threat categories.
Action	Set what action the Zyxel Device takes when there is a DNS query packet containing an FQDN with a bad reputation. redirect : Select this action to have the Zyxel Device reply with a DNS reply packet containing a default or custom-defined IP address. pass : Select this action to have the Zyxel Device allow the DNS query packet and not reply with a DNS reply packet containing a default or custom-defined IP address.
Log	These are the log options: no : Do not create a log when there is a DNS query packet containing an FQDN with a bad reputation. log : Create a log on the Zyxel Device when there is a DNS query packet containing an FQDN with a bad reputation. log alert : An alert is an emailed log for more serious events that may need more immediate attention. Select this to have the Zyxel Device send an alert when there is a DNS query packet containing an FQDN with a bad reputation.
Redirect IP	Select this action to have the Zyxel Device reply with a DNS reply packet containing a default or custom-defined IP address when a DNS query packet contains an FQDN with a bad reputation. The default IP is the dnsft.cloud.zyxel.com IP address. If you select custom-defined IP , then enter a valid IPv4 address in the text box.

Table 164 Security Service > Reputation Filter > DNS Threat Filter (continued)

LABEL	DESCRIPTION
Action When detecting malformed DNS packets	<p>Set what action the Zyxel Device takes when there is an abnormal DNS query packet. A DNS packet is defined as malformed when:</p> <ul style="list-style-type: none"> • The number of entries in the question count field in the DNS header is 0 • An error occurs when parsing the domain name in the question field • The length of the domain name exceeds 255 characters. <p>pass: Select this action to have the Zyxel Device allow the DNS query packet through the Zyxel Device.</p> <p>drop: Select this action to have the Zyxel Device discard the abnormal DNS query packet</p> <p>Select Log to create a log on the Zyxel Device when there is an abnormal DNS query packet.</p>
Statistics	<p>Enable to have the Zyxel Device collect DNS threat filter statistics. All of the statistics are erased if you restart the Zyxel Device or click Flush Data in Security Statistics > Reputation Filter > DNS Threat Filter.</p>
Security Threat Categories	<p>Select the categories of FQDNs that may pose a security threat to network devices behind the Zyxel Device.</p>
Anonymizers	<p>Sites and proxies that act as an intermediary for surfing to other Web sites in an anonymous fashion, whether to circumvent Web filtering or for other reasons.</p>
Browser Exploits	<p>Sites that contain browser exploits. A browser exploit is any content that forces a web browser to perform operations that you do not explicitly intend.</p>
Malicious Downloads	<p>Sites that have been identified as containing malicious downloads or malware harmful to a user's computer.</p>
Malicious Sites	<p>Sites that install unwanted software on a user's computer with the intent to enable third-party monitoring or make system changes without the user's consent.</p>
Phishing	<p>Sites that are used for deceptive or fraudulent purposes, such as stealing financial or other user account information. These sites are most often designed to appear as legitimate sites in order to mislead users into entering their credentials.</p>
Spam URLs	<p>Sites that have been promoted through spam techniques.</p>
Spyware Adware Keyloggers	<p>Sites that contain spyware, adware or keyloggers.</p> <ul style="list-style-type: none"> • Spyware is a program installed on your computer, usually without your explicit knowledge, that captures and transmits personal information or Internet browsing habits and details to companies. Companies use this information to analyze browsing habits, to gather marketing data, and to sell your information to others. • Key logger programs try to capture and steal your passwords and watch and record everything you do on your computer. • Adware programs typically display blinking advertisements or pop-up windows when you perform a certain action. Adware programs are often installed in exchange for another service, such as the right to use a program without paying for it.
Test Domain Name Category	
Domain name to test	<p>Enter an FQDN and click the Query button to check if the domain name is associated with suspicious activities that could pose a security threat to users or their computers.</p>
Apply	<p>Click Apply to save your changes.</p>
Reset	<p>Click Reset to return the screen to its last-saved settings.</p>

18.3.1 DNS Threat Filter Allow List



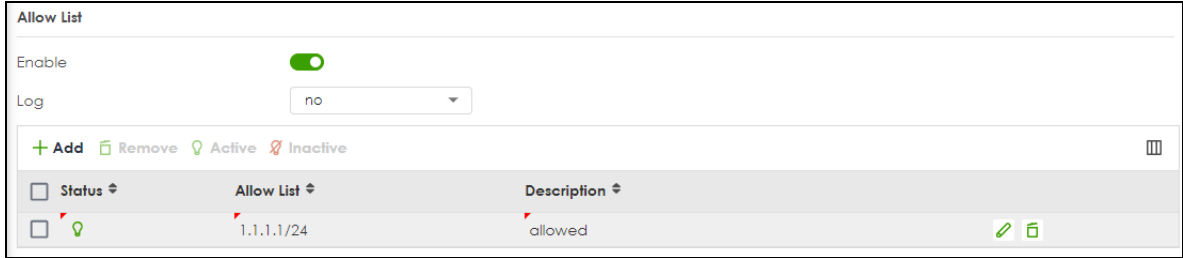

Use this to create allow list entries. The Zyxel Device will not reply with a DNS reply packet containing a default or custom-defined IP address when a DNS query packet contains an FQDN in the allow list.

Click **Security Service > Reputation Filter > DNS Threat Filter (Allow List)** to display the configuration screen as shown next.

Figure 208 Security Service > Reputation Filter > DNS Threat Filter (Allow List)

The following table describes the labels in this screen.

Table 165 Security Service > Reputation Filter > DNS Threat Filter (Allow List)

LABEL	DESCRIPTION
Enable	Select this check box and the Zyxel Device will not reply with a DNS reply packet containing a default or custom-defined IP address when a DNS query packet contains an FQDN in the white list.
Add	Click this to create a new entry. To add an FQDN, type a Fully-Qualified Domain Name (FQDN) of a web site. An FQDN starts with a host name and continues all the way up to the top-level domain name. For example, www.zyxel.com.tw is a fully qualified domain name, where "www" is the host, "zyxel" is the third-level domain, "com" is the second-level domain, and "tw" is the top level domain. Underscores are not allowed. Use "*" as a prefix in the FQDN for a wildcard domain name (for example, *.example.com).
Edit	Select an entry and click this to be able to modify it.
Remove	Select an entry and click this to delete it.
Active	To turn on an entry, select it and click Active .
Inactive	To turn off an entry, select it and click Inactive .
Status	The activate (light bulb) icon is lit when the entry is active and dimmed when the entry is inactive.
Allow List	Enter an IP address (with CIDR or a range) or a domain name (wildcard permitted) that will be allowed without DNS Threat filtering.
Description	Enter a description for this profile.
Edit	Select an entry and click this icon to modify it. 
Remove	Select an entry and click this icon to delete it. 
Save Changes	Click this icon to save the changes in this row. 
Cancel Changes	Click this icon to cancel the changes in this row. 

18.3.2 DNS Threat Filter Block List





Use this to create block list entries. The Zyxel Device will reply with a DNS reply packet containing a default or custom-defined IP address when a DNS query packet contains an FQDN in the block list. For matched items in the block list, the action is always **Redirect IP** and log is always **log alert**.

Click **Security Service > Reputation Filter > DNS Threat Filter (Block List)** to display the configuration screen as shown next.

Figure 209 Security Service > Reputation Filter > DNS Threat Filter (Block List)

The following table describes the labels in this screen.

Table 166 Security Service > Reputation Filter > DNS Threat Filter (Block List)

LABEL	DESCRIPTION
Block List	
Enable	Select this check box and the Zyxel Device will reply with a DNS reply packet containing a default or custom-defined IP address when a DNS query packet contains an FQDN in the black list.
Add	Click this to create a new entry. To add an FQDN, type a Fully-Qualified Domain Name (FQDN) of a web site. An FQDN starts with a host name and continues all the way up to the top-level domain name. For example, www.zyxel.com.tw is a fully qualified domain name, where "www" is the host, "zyxel" is the third-level domain, "com" is the second-level domain, and "tw" is the top level domain. Underscores are not allowed. Use "*" as a prefix in the FQDN for a wildcard domain name (for example, *.example.com).
Edit	Select an entry and click this to be able to modify it.
Remove	Select an entry and click this to delete it.
Active	To turn on an entry, select it and click Active .
Inactive	To turn off an entry, select it and click Inactive .
Status	The activate (light bulb) icon is lit when the entry is active and dimmed when the entry is inactive.
Block List	Enter an IP address (with CIDR or a range) or a domain name (wildcard permitted) that will be blocked without DNS Threat filtering.
Description	Enter a description for this profile.
Edit	Select an entry and click this icon to modify it. 
Remove	Select an entry and click this icon to delete it. 
Save Changes	Click this icon to save the changes in this row. 
Cancel Changes	Click this icon to cancel the changes in this row. 

18.3.3 DNS Threat Filter SecuReporter Allow List

Use this to view SecuReporter allow list entries. To remove an items from this list, you must go to SecuReporter. The Zyxel Device will not reply with a DNS reply packet containing a default or custom-defined IP address when a DNS query packet contains an FQDN in the allow list.

Click **Security Service > Reputation Filter > DNS Threat Filter_SecuReporter Allow List** to display the configuration screen as shown next.

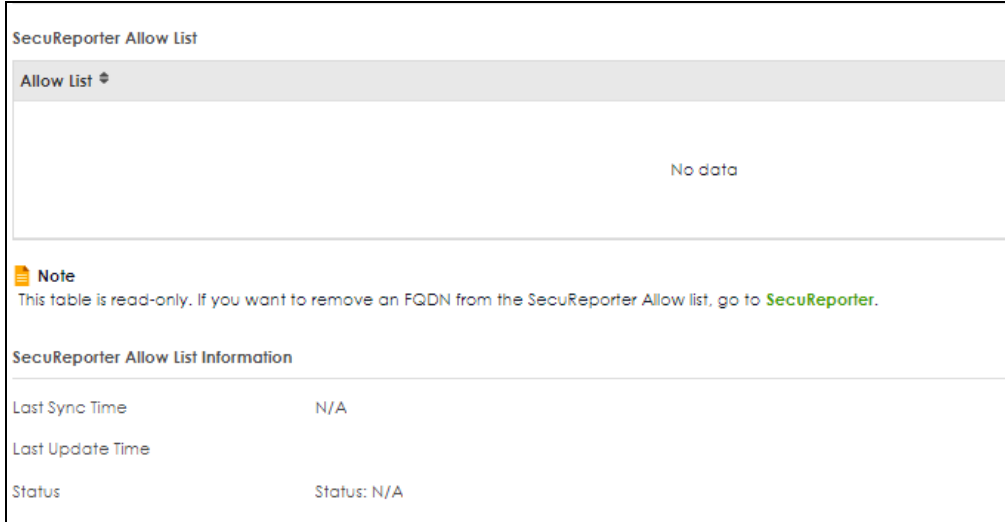
Figure 210 Security Service > Reputation Filter > DNS Threat Filter_SecuReporter Allow List

SecuReporter Allow List

Allow List

No data

Note
This table is read-only. If you want to remove an FQDN from the SecuReporter Allow list, go to [SecuReporter](#).

SecuReporter Allow List Information

Last Sync Time	N/A
Last Update Time	
Status	Status: N/A

The following table describes the labels in this screen.

Table 167 Security Services > Reputation Filter > DNS Threat Filter_SecuReporter Allow List

LABEL	DESCRIPTION
Allow List	This read-only table displays the SecuReporter allow list entries.
SecuReporter Allow List Information	
Last Sync Time	This field displays the date and time the Zyxel Device last checked for new SecuReporter allow list entries.
Last Update Time	This field displays the date and time the Zyxel Device last updated SecuReporter allow list entries.
Status	This field displays the status of SecuReporter allow list entries: Success , Parse message error , HTTP error , Connection timeout and Error . If an error is received, make sure the Zyxel Device has Internet access and can connect to the SecuReporter portal.
Apply	Click Apply to save your changes.
Cancel	Click Cancel to return the screen to its last-saved settings.

18.4 URL Threat Filter Screen

The Zyxel Device will access the Cloud Query database, that has millions of web sites categorized based on content. You can have the Zyxel Device allow, block, warn and/or log access to web sites or hosts based on these categories.

The priority for URL Threat checking is as follows:

- 1 Allow List
- 2 SecuReporter Allow List
- 3 Block List
- 4 External Block List

- 5 Cloud Query Cache
- 6 Cloud Query

Use this screen to enable URL Threat filtering and specify the action the Zyxel Device takes when it detects a suspicious activity or a connection attempt to or from a site in a selected category.

Click **Security Service > Reputation Filter > URL Threat Filter** to display the configuration screen as shown next.

Figure 211 Security Service > Reputation Filter > URL Threat Filter

The following table describes the labels in this screen.

Table 168 Security Service > Reputation Filter > URL Threat Filter

LABEL	DESCRIPTION
URL Blocking	
Enable	Select this option to turn on URL blocking on the Zyxel Device.
Action	Set what action the Zyxel Device takes when it detects a connection attempt to or from the web pages of the specified categories. block: Select this action to have the Zyxel Device block access to the web pages that match the categories that you select above. pass: Select this action to have the Zyxel Device allow access to the web pages that match the categories that you select above.

Table 168 Security Service > Reputation Filter > URL Threat Filter (continued)

LABEL	DESCRIPTION
Log	<p>These are the log options:</p> <ul style="list-style-type: none"> • no: Do not create a log when it detects a connection attempt to or from the web pages of the specified categories. • log: Create a log on the Zyxel Device when it detects a connection attempt to or from the web pages of the specified categories. • log alert: An alert is an emailed log for more serious events that may need more immediate attention. Select this option to have the Zyxel Device send an alert when a connection matches web pages of the specified categories.
Statistics	<p>Enable to have the Zyxel Device collect URL threat filter statistics. All of the statistics are erased if you restart the Zyxel Device or click Flush Data in Security Statistics > Reputation Filter > URL Threat Filter.</p>
Message to display when a site is blocked	
Denied Access Message	<p>Enter a message to be displayed when the URL Threat filter blocks access to a web page. Use up to 127 characters (0-9a-zA-Z;/?:@&+\$.~*()%,"). For example, "Access to this web page is not allowed. Please contact the network administrator".</p> <p>It is also possible to leave this field blank if you have a URL specified in the Redirect URL field. In this case if the URL Threat filter blocks access to a web page, the Zyxel Device just opens the web page you specified without showing a denied access message.</p>
Redirect URL	<p>Enter the URL of the web page to which you want to send users when their web access is blocked by the URL Threat filter. The web page you specify here opens in a new frame below the denied access message.</p> <p>Use "http://" or "https://" followed by up to 262 characters (0-9a-zA-Z;/?:@&+\$.~*()%,"). For example, http://192.168.1.17/blocked access.</p>
Security Threat Categories	<p>Select the categories of web pages that may pose a security threat to network devices behind the Zyxel Device.</p>
Anonymizers	<p>Sites and proxies that act as an intermediary for surfing to other Web sites in an anonymous fashion, whether to circumvent Web filtering or for other reasons.</p>
Browser Exploits	<p>Sites that contain browser exploits. A browser exploit is any content that forces a web browser to perform operations that you do not explicitly intend.</p>
Malicious Downloads	<p>Sites that have been identified as containing malicious downloads or malware harmful to a user's computer.</p>
Malicious Sites	<p>Sites that install unwanted software on a user's computer with the intent to enable third-party monitoring or make system changes without the user's consent.</p>
Phishing	<p>Sites that are used for deceptive or fraudulent purposes, such as stealing financial or other user account information. These sites are most often designed to appear as legitimate sites in order to mislead users into entering their credentials.</p>
Spam URLs	<p>Sites that have been promoted through spam techniques.</p>
Spyware Adware Keyloggers	<p>Sites that contain spyware, adware or keyloggers.</p> <ul style="list-style-type: none"> • Spyware is a program installed on your computer, usually without your explicit knowledge, that captures and transmits personal information or Internet browsing habits and details to companies. Companies use this information to analyze browsing habits, to gather marketing data, and to sell your information to others. • Key logger programs try to capture and steal your passwords and watch and record everything you do on your computer. • Adware programs typically display blinking advertisements or pop-up windows when you perform a certain action. Adware programs are often installed in exchange for another service, such as the right to use a program without paying for it.
Test URL Threat Category	
URL to test	<p>Enter a URL using http://domain or https://domain and click the Query button to check if the domain belongs to a URL threat category.</p>

Table 168 Security Service > Reputation Filter > URL Threat Filter (continued)

LABEL	DESCRIPTION
Apply	Click Apply to save your changes.
Cancel	Click Cancel to return the screen to its last-saved settings.

18.4.1 URL Threat Filter Allow List

Use this to create allow list entries. The Zyxel Device will allow incoming packets from the listed IPv4 addresses and URLs.

Click **Security Service > Reputation Filter > URL Threat Filter (Allow List)** to display the configuration screen as shown next.

Figure 212 Security Service > Reputation Filter > URL Threat Filter (Allow List)

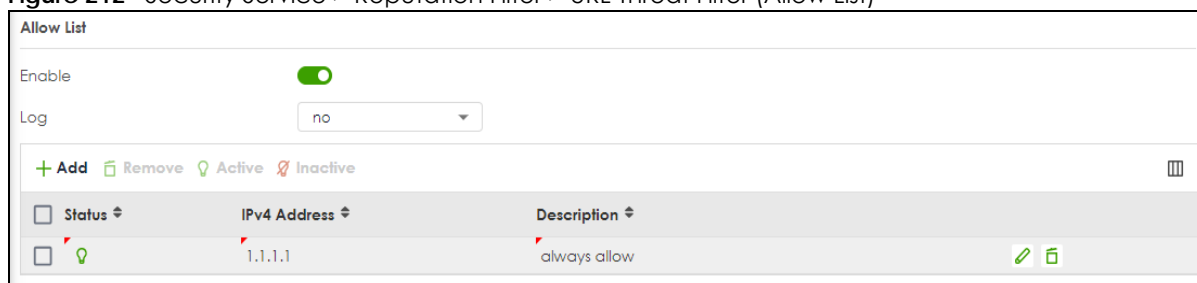

The following table describes the labels in this screen.

Table 169 Security Service > Reputation Filter > URL Threat Filter (Allow List)





LABEL	DESCRIPTION
Enable	Select this to bypass checking by this feature (if enabled) and automatically allow packets from the listed IPv4 addresses and URLs.
Log	These are the log options: <ul style="list-style-type: none"> no: Do not create a log when the Zyxel Device detects a connection attempt to or from the web pages of the specified categories listed in the allow list. log: Create a log on the Zyxel Device when it detects a connection attempt to or from the web pages of the specified categories listed in the allow list.
Add	Click this to create a new entry.
Remove	Select an entry and click this to delete it.
Active	To turn on an entry, select it and click Active .
Inactive	To turn off an entry, select it and click Inactive .
Status	The status (light bulb) icon is lit when the entry is active and dimmed when the entry is inactive.
Allow List	Enter an IP address (with CIDR or a range) or a domain name (wildcard permitted) that will be allowed without URL Threat filtering.
Description	Enter a description for this profile.
Edit	Select an entry and click this icon to modify it. 
Remove	Select an entry and click this icon to delete it. 

Table 169 Security Service > Reputation Filter > URL Threat Filter (Allow List) (continued)

LABEL	DESCRIPTION
Save Changes	Click this icon to save the changes in this row. 
Cancel Changes	Click this icon to cancel the changes in this row. 

18.4.2 URL Threat Filter Block List

Use this to create block list entries. The Zyxel Device will block incoming packets from the listed URLs.

Click **Security Service > Reputation Filter > URL Threat Filter (Block List)** to display the configuration screen as shown next.

Figure 213 Security Service > Reputation Filter > URL Threat Filter (Block List)

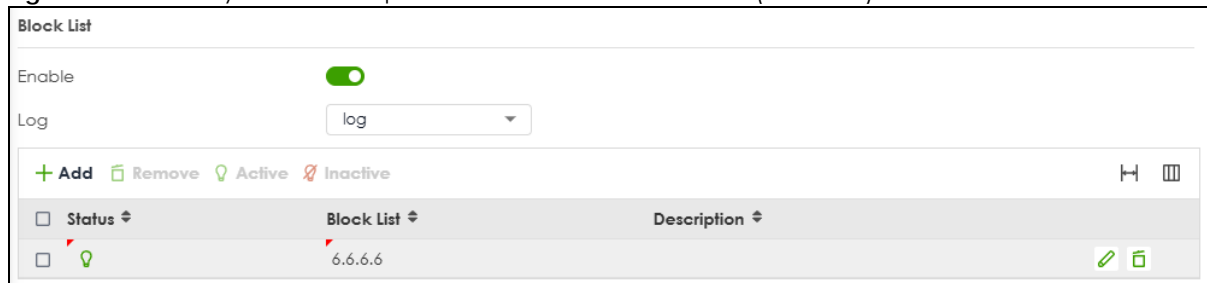

The following table describes the labels in this screen.

Table 170 Security Service > Reputation Filter > URL Threat Filter_Block List





LABEL	DESCRIPTION
Enable	Select this to bypass checking by this feature (if enabled) and automatically block packets from the listed IPv4 addresses and URLs.
Log	These are the log options: <ul style="list-style-type: none"> no: Do not create a log when it detects a connection attempt to or from the web pages of the specified categories listed in the block list. log: Create a log on the Zyxel Device when it detects a connection attempt to or from the web pages of the specified categories listed in the block list. log alert: An alert is an emailed log for more serious events that may need more immediate attention. Select this option to have the Zyxel Device send an alert when a connection matches web pages of the specified categories listed in the block list.
Add	Click this to create a new entry.
Active	To turn on an entry, select it and click Active . The Status light changes accordingly.
Inactive	To turn off an entry, select it and click Inactive . The Status light changes accordingly.
Status	This icon is lit when the entry is active and dimmed when the entry is inactive.
Remove	Select an entry and click this to delete it.
Block List	Enter an IP address (with CIDR or a range) or a domain name (wildcard permitted) that will be blocked without URL Threat filtering.
Description	Enter a description for this profile.
Edit	Select an entry and click this icon to modify it. 

Table 170 Security Service > Reputation Filter > URL Threat Filter_Block List (continued)

LABEL	DESCRIPTION
Remove	Select an entry and click this icon to delete it. 
Save Changes	Click this icon to save the changes in this row. 
Cancel Changes	Click this icon to cancel the changes in this row. 

18.4.3 URL Threat Filter SecuReporter Allow List

Use this to view SecuReporter allow list entries. To remove an items from this list, you must go to SecuReporter. The Zyxel Device will allow packets coming from the Internet and going out from the local network that match the listed URLs.

Click **Security Service > Reputation Filter > URL Threat Filter _SecuReporter Allow List** to display the configuration screen as shown next.

Figure 214 Security Service > Reputation Filter > URL Threat Filter_SecuReporter Allow List



SecuReporter Allow List	
Allow List ▾	
No data	
<p>Note This table is read-only. If you want to remove an website from the SecuReporter Allow list, go to SecuReporter.</p>	
SecuReporter Allow List Information	
Last Sync Time	N/A
Last Update Time	N/A
Status	Status: N/A

The following table describes the labels in this screen.

Table 171 Security Services > Reputation Filter > URL Threat Filter_SecuReporter Allow List

LABEL	DESCRIPTION
Allow List	This read-only table displays the SecuReporter allow list entries.
SecuReporter Allow List Information	
Last Sync Time	This field displays the date and time the Zyxel Device last checked for new SecuReporter allow list entries.
Last Update Time	This field displays the date and time the Zyxel Device last updated SecuReporter allow list entries.
Status	This field displays the status of SecuReporter allow list entries: Success , Parse message error , HTTP error , Connection timeout and Error . If an error is received, make sure the Zyxel Device has Internet access and can connect to the SecuReporter portal.

Table 171 Security Services > Reputation Filter > URL Threat Filter_SecuReporter Allow List (continued)

LABEL	DESCRIPTION
Apply	Click Apply to save your changes.
Cancel	Click Cancel to return the screen to its last-saved settings.

CHAPTER 19

Anti-Malware

19.1 Overview

Malware is short for malicious software, such as computer viruses, worms and spyware. The Zyxel Device anti-malware feature protects your connected network from malware by scanning traffic coming in from the WAN and going out from the WAN. The traffic scanned by the Zyxel Device may include FTP traffic and email with attachments.

Figure 215 Zyxel Device Anti-Malware Example

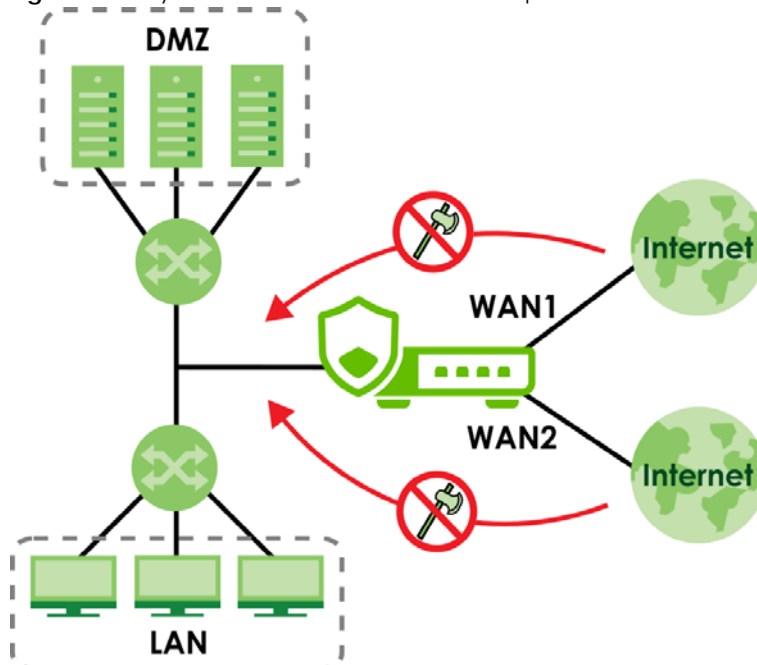

The Zyxel Device queries the **Defend Center** database by sending the file's hash value (A) and receiving the scan results (B) through the Defend Center (DC).

Figure 216 Cloud Query

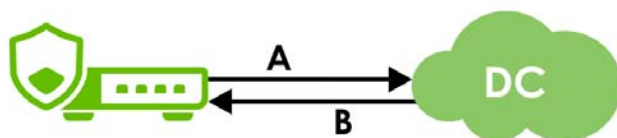

Viruses, Worms, and Spyware

A computer virus is a type of malicious software designed to corrupt and/or alter the operation of other legitimate programs. A worm is a self-replicating virus. Spyware infiltrates your device to secretly gather information, such as your network activity, passwords, bank details, and so on.

The following describes a simple life cycle of malware.

- 1 A computer gets a copy of malware from a source such as the Internet, email, file sharing or any removable storage media. The malware is harmless until the execution of an infected program.
- 2 The malware spreads to other files and programs on the computer.
- 3 The infected files are unintentionally sent to another computer thus starting the spread of the malware.
- 4 Once the malware is spread through the network, the number of infected networked computers can grow exponentially.

Types of Malware

The following table describes some of the common malware.

Table 172 Common Malware Types

TYPE	DESCRIPTION
File Infector	This is a small program that embeds itself in a legitimate program. A file infector is able to copy and attach itself to other programs that are executed on an infected computer.
Boot Sector Virus	This type of virus infects the area of a hard drive that a computer reads and executes during startup. The virus causes computer crashes and to some extent renders the infected computer inoperable.
Macro Virus	Macro viruses or Macros are small programs that are created to perform repetitive actions. Macros run automatically when a file to which they are attached is opened. Macros spread more rapidly than other types of viruses as data files are often shared on a network.
Email Virus	Email viruses are malicious programs that spread through email.
Polymorphic Virus	A polymorphic virus (also known as a mutation virus) tries to evade detection by changing a portion of its code structure after each execution or self replication. This makes it harder for an anti-malware scanner to detect or intercept it. A polymorphic virus can also belong to any of the virus types discussed above.

Hash Value

A hash function is an algorithm that maps data of arbitrary size to data of fixed size. The value returned by a hash function is a hash value. Hash values can be used to identify if the contents of a file have changed. At the time of writing, the MD5 (Message Digest 5) hash algorithm is supported.

Anti-Malware Scan Process

Before going through the Anti-Malware scan, the Zyxel Device first identifies the packets sent by the following four major protocols with corresponding standard ports:

- FTP (File Transfer Protocol)
- HTTP (Hyper Text Transfer Protocol)

- SMTP (Simple Mail Transfer Protocol)
- POP3 (Post Office Protocol version 3)

The Zyxel Device records the orders of packets in TCP connection-oriented sessions to check for matching malware signatures. The order of non-setup packets such as SYN, ACK and FIN is ignored.

Anti-Malware Scanning Procedure:

- 1 The Zyxel Device uses **Cloud Query** to forward the file's MD5 hash value to Defend Center.
- 2 If the MD5 hash value is incorrect, then the last packet of the file is removed. The file is still forwarded to the receiver, but they will not be able to open it. You can configure to receive an alert or log when this happens.

Note: The receiver is not notified if a file is modified by the Zyxel Device. If the file cannot be used, the receiver should contact the Zyxel Device administrator to confirm if the Zyxel Device modified the file by checking the logs.

File Scanning Cloud Query Supported File Types

At the time of writing, the following file types are supported:

Table 173 File Scanning Cloud Query Supported File Types

• 7z Archive (7z)	• AVI Video (avi)	• BMP Image (bmp)	• BZ2 Archive (bz2)
• Executables (exe)	• Macromedia Flash Data (swf)	• GIF Image (gif)	• GZ Archive (gz)
• JPG Image (jpg)	• MOV Video (mov)	• MP3 Audio (mp3)	• MPG Video (mpg)
• MS Office Document (doc...)	• PDF Document (pdf)	• PNG Image (png)	• RAR Archive (rar)
• RM Video (rm)	• RTF Document (rtf)	• TIFF Image (tif)	• WAV Audio (wav)
• ZIP Archive (zip)			

Notes About the Zyxel Device Anti-Malware

The following lists important notes about the Zyxel Device's anti-malware feature:

- 1 Zyxel's anti-malware feature can detect polymorphic malware (see [Section 19.1 on page 341](#)).
- 2 When malware is detected, a log is created or an alert message is sent to the administrator depending on your log settings.
- 3 Changes to the Zyxel Device's anti-malware settings only affect new sessions, not sessions that already existed before you applied the changed settings.
- 4 Enabling **Cloud Query** may affect file transfer speeds.
- 5 The Zyxel Device does not scan the following file/traffic types:
 - Simultaneous downloads of a file using multiple connections. For example, when you use FlashGet to download sections of a file simultaneously.

- Encrypted traffic. This could be password-protected files or VPN traffic where the Zyxel Device is not the endpoint (pass-through VPN traffic).
- Traffic through custom (non-standard) ports. The Zyxel Device scans whatever port number is specified for FTP in the ALG screen.

Finding Out More

- See [Section 19.5 on page 350](#) for anti-malware background information.

19.1.1 What You Can Do in this Chapter

- Use the **Anti-Malware** screen ([Section 19.2 on page 344](#)) to turn anti-malware on or off. In addition, you can set up anti-malware blocked and allowed lists to bypass anti-malware checking.
- Use the **Allow List** screen ([Section 19.3 on page 346](#)) to specify the file or encryption pattern to allow in order to avoid false positives.
- Use the **Block List** screen ([Section 19.4 on page 348](#)) to specify the file or encryption pattern that you want to block.

19.2 Anti-Malware Screen

Click **Security Service > Anti-Malware** to display the configuration screen as shown next.

If a license has expired, you will see a reminder in this screen. You need to renew the license in order to keep using the feature. Click **Buy Now** to go to Marketplace to purchase a new license. Click **See Details** to go to the Zyxel web page to find more information on licenses for your Zyxel Device.

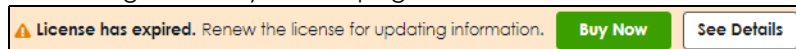

Click the **Anti-Malware** icon for more information on the Zyxel Device's security features.

Note: See [Section on page 105](#) for more information on the subscription services for the two types of security packs.

Note: If **Destroy infected file** is disabled and **log** is set to **no**, the Zyxel Device will still perform the scan but will not do anything else. It is recommended to enable at least one of the two functions.

If Destroy infected file is disabled, any malicious file found can still be executed by the end user after it is forwarded. The administrator would have to inform the user if there is an infected file.

Figure 217 Security Service > Anti-Malware

Security Services > Anti-Malware

General Settings

Enable Anti-Malware

Collect Statistics

Scan and detect EICAR test virus

File size limit (MB)

Actions When Matched

Destroy infected file

Log

File Type For Scan

Available

Filter items...

Select All

- GIF Image (gif)
- GZ Archive (gz)
- JPG Image (jpg)
- MOV Video (mov)
- MP3 Audio (mp3)
- MPG Video (mpg)
- PNG Image (png)
- RAR Archive (rar)
- RM Video (rm)
- TIFF Image (tif)

Member

Filter items...

Select All

- Executables (exe)
- MS Office Document (doc...)
- Macromedia Flash Data (swf)
- PDF Document (pdf)
- RTF Document (rtf)
- ZIP Archive (zip)

The following table describes the labels in this screen.

Table 174 Security Service > Anti-Malware

LABEL	DESCRIPTION
General Setting	
Enable	Click to activate the anti-malware feature to protect your connected network from infection and the installation of malicious software.
Collect Statistics	Click to have the Zyxel Device collect anti-malware statistics. All of the statistics are erased if you restart the Zyxel Device or click Flush Data in Security Statistics > Anti-Malware .
Scan and detect EICAR test virus	Click to have the Zyxel Device check for an EICAR test file and treat it in the same way as a real malware file. The EICAR test file is a standardized test file for signature based anti-malware scanners. When the scanner detects the EICAR file, it responds in the same way as if it found real malware. The EICAR file can also be compressed to test whether the anti-malware software can detect it in a compressed file. The test string consists of the following human-readable ASCII characters. X5O!P%@AP[4\PZX54(P^)7CC}7}\$EICAR-STANDARD-ANTIVIRUS-TEST-FILE!\$H+H*
File size limit	Set the limit of the file size the Zyxel Device anti-malware will scan. A file that exceeds the file size you set here will pass without been scanned by the Zyxel Device anti-malware.
Destroy infected file	When you select this check box, if a malware signature is matched, the Zyxel Device overwrites the infected portion of the file with zeros before being forwarded to the user. The uninfected portion of the file will pass through unmodified.

Table 174 Security Service > Anti-Malware (continued)

LABEL	DESCRIPTION
Log	These are the log options: <ul style="list-style-type: none"> • no: Do not create a log when a packet matches a signature. • log: Create a log on the Zyxel Device when a packet matches a signature. • log alert: An alert is an emailed log for more serious events that may need more immediate attention. Select this option to have the Zyxel Device send an alert when a packet matches a signature(s).
File Type for Scan	File types that can be checked by the Zyxel Device are listed here. Note that the files on this list are currently bypassed. To use this feature on a specific file type, click this file type and then click the right arrow button. See available file types in Table 173 on page 343 .
Search	Type an item in the search box, then click this to display all file types in the table below according to the item you typed.
Select All	Select this to select all file types in the table.
Apply	Click Apply to save your changes.
Cancel	Click Cancel to return the screen to its last-saved settings.

19.3 The Allow List Screen

A allow list allows you to specify an MD5 hash or file pattern to ignore in order to avoid false positives. False positives occur when a non-infected file matches a malware signature.

Enter a file or encryption pattern that would cause the Zyxel Device to allow this file.

Click **Security Service > Anti-Malware > Allow List** to display the following screen. Use **Add** to put a new entry in the list or **Edit** to change an existing one or **Remove** to delete an existing entry.

Figure 218 Security Service > Anti-Malware > Allow List

The following table describes the fields in this screen.

Table 175 Security Service > Anti-Malware > Allow List











LABEL	DESCRIPTION
Enable Allow List	Select this to bypass checking by this feature (if enabled) and automatically allow incoming files with names or hash value (MD5 Hash) that match the white list patterns.
Log	These are the log options: <ul style="list-style-type: none"> no: Do not create a log when a packet matches a signature. log: Create a log on the Zyxel Device when a packet matches a signature.
MD5 Hash	Configure the settings to automatically allow incoming files with MD5 Hash value that match the patterns you set. An MD5 hash can consist of 32 alpha-numerical characters.
Add	Click this to create a new entry.
Remove	Select an entry and click this to delete it.
Active	To turn on an entry, select it and click Active .
Inactive	To turn off an entry, select it and click Inactive .
Column ()	Click the column icon to select the fields you want to show in the table. Uncheck the checkbox if you want to hide a field in the table.
Status	The activate (light bulb) icon is lit when the entry is active and dimmed when the entry is inactive.
Value	This field displays the hash pattern of the entry. Enter the hash pattern for this entry. Specify a pattern to identify the names of files that the Zyxel Device should not scan for viruses.
Edit	Select an entry and click this icon to modify it. 
Remove	Select an entry and click this icon to delete it. 
Save Changes	Click this icon to save the changes in this row. 
Cancel Changes	Click this icon to cancel the changes in this row. 
File Name Pattern	Configure the settings to automatically allow incoming files with names that match the patterns you set.
Add	Click this to create a new entry.
Remove	Select an entry and click this to delete it.
Active	To turn on an entry, select it and click Active .
Inactive	To turn off an entry, select it and click Inactive .
Column ()	Click the column icon to select the fields you want to show in the table. Uncheck the checkbox if you want to hide a field in the table.
Status	The activate (light bulb) icon is lit when the entry is active and dimmed when the entry is inactive.

Table 175 Security Service > Anti-Malware > Allow List

LABEL	DESCRIPTION
Name	<p>This field displays the file pattern of the entry.</p> <p>Enter the file pattern for this entry. Specify a pattern to identify the names of files that the Zyxel Device should not scan for viruses.</p> <ul style="list-style-type: none"> • Use up to 80 characters. Alphanumeric characters, underscores (_), dashes (-), question marks (?) and asterisks (*) are allowed. • A question mark (?) lets a single character in the file name vary. For example, use "a?.zip" (without the quotation marks) to specify aa.zip, ab.zip and so on. • Wildcards (*) let multiple files match the pattern. For example, use "*a.zip" (without the quotation marks) to specify any file that ends with "a.zip". A file named "testa.zip" would match. There could be any number (of any type) of characters in front of the "a.zip" at the end and the file name would still match. A file named "test.zipa" for example would not match. • A * in the middle of a pattern has the Zyxel Device check the beginning and end of the file name and ignore the middle. For example, with "abc*.zip", any file starting with "abc" and ending in ".zip" matches, no matter how many characters are in between. • The whole file name has to match if you do not use a question mark or asterisk. • If you do not use a wildcard, the Zyxel Device checks up to the first 80 characters of a file name.
Edit	<p>Select an entry and click this icon to modify it.</p> 
Remove	<p>Select an entry and click this icon to delete it.</p> 
Save Changes	<p>Click this icon to save the changes in this row.</p> 
Cancel Changes	<p>Click this icon to cancel the changes in this row.</p> 

19.4 The Block List Screen

A block list allows you to specify a specific MD5 hash or file pattern that you want to block.

Enter a file or encryption pattern that would cause the Zyxel Device to log and then destroy this file.

Click **Security Service > Anti-Malware > Block List** to display the following screen. Use **Add** to put a new entry in the list or **Edit** to change an existing one or **Remove** to delete an existing entry.

Figure 219 Security Service > Anti-Malware > Block List

The following table describes the fields in this screen.

Table 176 Security Services > Anti-Malware > Block/Allow List > Block List











LABEL	DESCRIPTION
Enable Block List	Select this to bypass checking by this feature (if enabled) and automatically block incoming files with names or hash value (MD5 Hash) that match the block list patterns.
Log	These are the log options: <ul style="list-style-type: none"> no: Do not create a log when a packet matches a signature. log: Create a log on the Zyxel Device when a packet matches a signature.
MD5 Hash	Configure the settings to automatically block incoming files with MD5 Hash value that match the patterns you set. An MD5 hash can consist of 32 alpha-numerical characters.
Add	Click this to create a new entry.
Remove	Select an entry and click this to delete it.
Active	To turn on an entry, select it and click Active .
Inactive	To turn off an entry, select it and click Inactive .
Column ()	Click the column icon to select the fields you want to show in the table. Clear the check box if you want to hide a field in the table.
Status	The activate (light bulb) icon is lit when the entry is active and dimmed when the entry is inactive.
Value	This field displays the hash pattern of the entry. Enter the hash pattern for this entry. Specify a pattern to identify the names of files that the Zyxel Device should not scan for viruses.
Edit	Select an entry and click this icon to modify it. 
Remove	Select an entry and click this icon to delete it. 

Table 176 Security Services > Anti-Malware > Block/Allow List > Block List (continued)

LABEL	DESCRIPTION
Save Changes	Click this icon to save the changes in this row. 
Cancel Changes	Click this icon to cancel the changes in this row. 
File Name Pattern	Configure the settings to automatically block incoming files with names that match the patterns you set.
Add	Click this to create a new entry.
Remove	Select an entry and click this to delete it.
Active	To turn on an entry, select it and click Active .
Inactive	To turn off an entry, select it and click Inactive .
Column ()	Click the column icon to select the fields you want to show in the table. Uncheck the checkbox if you want to hide a field in the table.
Status	The activate (light bulb) icon is lit when the entry is active and dimmed when the entry is inactive.
Value	<p>This field displays the file pattern of the entry.</p> <p>Enter the file pattern for this entry. Specify a pattern to identify the names of files that the Zyxel Device should not scan for viruses.</p> <ul style="list-style-type: none"> Use up to 80 characters. Alphanumeric characters, underscores (_), dashes (-), question marks (?) and asterisks (*) are allowed. A question mark (?) lets a single character in the file name vary. For example, use "a?.zip" (without the quotation marks) to specify aa.zip, ab.zip and so on. Wildcards (*) let multiple files match the pattern. For example, use "*a.zip" (without the quotation marks) to specify any file that ends with "a.zip". A file named "testa.zip" would match. There could be any number (of any type) of characters in front of the "a.zip" at the end and the file name would still match. A file named "test.zipa" for example would not match. A * in the middle of a pattern has the Zyxel Device check the beginning and end of the file name and ignore the middle. For example, with "abc*.zip", any file starting with "abc" and ending in ".zip" matches, no matter how many characters are in between. The whole file name has to match if you do not use a question mark or asterisk. If you do not use a wildcard, the Zyxel Device checks up to the first 80 characters of a file name.
Edit	Select an entry and click this icon to modify it. 
Remove	Select an entry and click this icon to delete it. 
Save Changes	Click this icon to save the changes in this row. 
Cancel Changes	Click this icon to cancel the changes in this row. 

19.5 Anti-Malware Technical Reference

Types of Anti-Malware Scanner

The section describes two types of anti-malware scanner: host-based and network-based.

A host-based anti-malware (HAM) scanner is often software installed on computers and/or servers on the network. It inspects files for malware patterns as they are moved in and out of the drive. However, host-based anti-malware scanners cannot eliminate all malware for a number of reasons:

- HAM scanners are slow in stopping malware threats through real-time traffic (such as from the Internet).
- HAM scanners may reduce computing performance as they also share resources (such as CPU time) on the computer for file inspection.
- You have to update the malware signatures and/or perform malware scans on all computers on the network regularly.

Note: The Zyxel Device does not support host-based anti-malware (HAM).

A network-based anti-malware (NAM) scanner is often deployed as a dedicated security device (such as your Zyxel Device) on the network edge. NAM scanners inspect real-time data traffic (such as email messages or web) that tends to bypass HAM scanners. The following lists some of the benefits of NAM scanners.

- NAM scanners stop malware threats at the network edge before they enter or exit a network.
- NAM scanners reduce computing loading on computers as the read-time data traffic inspection is done on a dedicated security device.

CHAPTER 20

Sandbox

20.1 Overview

Zyxel sandbox is a security mechanism which provides a safe environment to separate running programs from your network and host devices. Files with unknown or untrusted programs and codes are uploaded to the cloud. These files are executed within an isolated virtual machine (VM) to monitor and analyze the zero-day malware and advanced persistent threats (APTs). The zero-day malware refers to malware that is unknown to any software vendor or developer. It is dangerous because there is no available defenses against it at the time of discovery.

The zero-day malware and APTs may evade the Zyxel Device's detection, such as anti-malware. Results of cloud sandbox are sent from the server to the Zyxel Device.

After checking the received files against its local cache, the Zyxel Device sandbox uploads a copy of the files for inspection if the files are not recorded in the local cache. The scan result from the cloud is added to the Zyxel Device cache and used for future inspection. When a file with malicious or suspicious code is detected, the Zyxel Device takes specific actions on the threats.

By default, the Zyxel Device sandbox forwards all files that have not been checked before to the clients behind the Zyxel Device.

Note: The scan results will be removed from the Zyxel Device cache after the Zyxel Device restarts. When the scan results stored reach the limit, new scan results automatically overwrite existing scan results, starting with the oldest scan result first.

Figure 220 Zyxel Sandbox Inspection

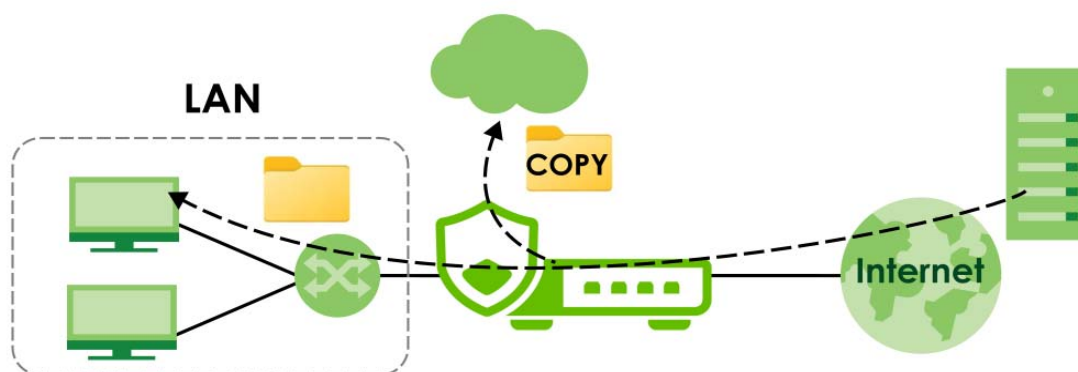

20.1.1 What You Need to Know

The Zyxel Device forwards files that are not recorded in the local cache to the client behind the Zyxel Device before sandbox has completed checking. The scan result will display in **Log & Report > Log/Events**. We suggest you to inform your client not to open the file until sandbox has completed checking. If the client already opened it, then please urge the client to run an up-to-date anti-malware scanner.

If the receiver of a suspect file cannot open a file, sandbox may have already modified the file by deleting the infected portion. Please check the logs and let the receiver know if this is so.

Sandbox can only check the types of files listed under **File Submission Options** in the **Sandbox** screen. If you disabled **Scan and detect EICAR test virus** in the **Anti-Malware** screen, then EICAR test files will be sent to sandbox.

To use the sandbox, you need to register your Zyxel Device and activate the service license at NCC, and then turn on the sandbox function on the Zyxel Device. See [Chapter 6 on page 105](#) for more information about registration and service licenses.

20.2 Sandbox Screen

Click **Security Service > Sandbox** to display the configuration screen as shown next.

If a license has expired, you will see a reminder in this screen. You need to renew the license in order to keep using the feature. Click **Buy Now** to go to Marketplace to purchase a new license. Click **See Details** to go to the Zyxel web page to find more information on licenses for your Zyxel Device.

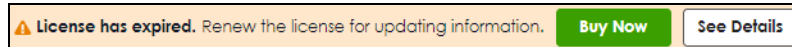

Use this screen to enable sandbox and specify the actions the Zyxel Device takes when malicious or suspicious files are detected.

Figure 221 Security Service > Sandbox

Security Services > Sandbox

General Settings

Enable Sandbox

Collect Statistics

Action For Malicious Files

Log For Malicious Files

Action For Suspicious Files

Log For Suspicious Files

File Types to Scan

Available

Filter items...

Select All

File Types to Scan

Filter items...

Select All

- Executables (exe)
- MS Office Document (doc...)
- Macromedia Flash Data (swf)
- PDF Document (pdf)
- RTF Document (rtf)
- ZIP Archive (zip)

Note

Use Nebula Security Profile Sync (SPS) to centralize and sync security settings across your devices; visit the [Nebula](#) to configure and sync your devices now.

The following table describes the labels in this screen.

Table 177 Security Service > Sandbox

LABEL	DESCRIPTION
General	
Enable Sandbox	Select this option to turn on sandbox if you have a license and have activated it on the Zyxel Device. Otherwise, deselect it.
Collect Statistics	Enable to have the Zyxel Device collect sandbox statistics, such as the time, type and name of the files scanned. The statistics collected will display in Security Statistics > Sandbox . All of the statistics are erased if you restart the Zyxel Device or click Flush Data in Security Statistics > Sandbox .
Action For Malicious File	Specify whether the Zyxel Device deletes (destroy) or forwards (allow) malicious files. Malicious files are files given a high score for malware characteristics by the cloud. You can check the medium score for malware characteristics given by the cloud in the logs.
Log For Malicious File	These are the log options for malicious files: <ul style="list-style-type: none"> • no: Do not create a log when a malicious file is detected. • log: Create a log on the Zyxel Device when a malicious file is detected. • log alert: An alert is an emailed log. Select this option to have the Zyxel Device send an alert when a malicious file is detected.
Action For Suspicious File	Specify whether the Zyxel Device deletes (destroy) or forwards (allow) suspicious files. Suspicious files are files given a medium score for malware characteristics by the cloud. You can check the medium score for malware characteristics given by the cloud in the logs.

Table 177 Security Service > Sandbox (continued)

LABEL	DESCRIPTION
Log For Suspicious File	<p>These are the log options for suspicious files:</p> <p>no: Do not create a log when a suspicious file is detected.</p> <p>log: Create a log on the Zyxel Device when a suspicious file is detected.</p> <p>log alert: An alert is an emailed log for more serious events that may need more immediate attention. Select this option to have the Zyxel Device send an alert when a suspicious file is detected.</p>
File Types to Scan	<p>Specify the type of files to be sent for sandbox inspection.</p> <ul style="list-style-type: none"> • Executables (exe): An executable file is a file that contains a program or application which your computer can run • MS Office Document (doc...): This category includes Microsoft Word files, Microsoft Excel files and Microsoft PowerPoint files. MS Office Document are files that are created using software developed by Microsoft. • Macromedia Flash Data (swf): A flash file (.swf) is a file that contains animations, multimedia elements or games. A flash file is often embedded into a web page. • PDF Document (pdf): A Portable Document Format (PDF) file is a file that maintains the presentation and formatting of documents across different platform and devices. • RTF Document (rtf): A Rich Text Format (RTF) file is a file that allows you to create text with different formats, such as bold or italics. • ZIP Archive (zip): A zip file is a file used to compress multiple files together into a single file. A zip file can reduce the overall size of a collection of files.
Search	Type an item in the search box, then click this to display all file types in the table below according to the item you typed.
Select All	Select this to select all file types in the table.
Apply	Click Apply to save your changes.
Cancel	Click Cancel to return the screen to its last-saved settings.

CHAPTER 21

IPS

21.1 Overview

This chapter introduces packet inspection IPS (Intrusion Prevention System), custom signatures, and updating signatures. An IPS system can detect malicious or suspicious packets and respond instantaneously by rejecting or dropping the packets. The Zyxel Device IPS protects your network against network-based intrusions.

21.1.1 What You Can Do in this Chapter

- Use the **Security Service > IPS** screen ([Section 21.2 on page 357](#)) to view registration and signature information.
- Use the **Security Service > IPS > Allow List** screen ([Section 21.3 on page 364](#)) to list signatures that will be exempted from IPS inspection.

21.1.2 What You Need To Know

Packet Inspection Signatures

A signature is a pattern of malicious or suspicious packet activity. You can specify an action to be taken if the system matches a stream of data to a malicious signature. You can change the action in the profile screens. Packet inspection examines OSI (Open System Interconnection) layer-4 to layer-7 packet contents for malicious data. Generally, packet inspection signatures are created for known attacks while anomaly detection looks for abnormal behavior.

Rate Based Signatures

While IPS signatures have the Zyxel Device respond instantaneously, **Rate Based Signatures** are IPS signatures that allow the Zyxel Device to just respond after a number of occurrences (**Count**) within a certain time period (**Period**) you set.

Figure 222 IPS Signatures Example

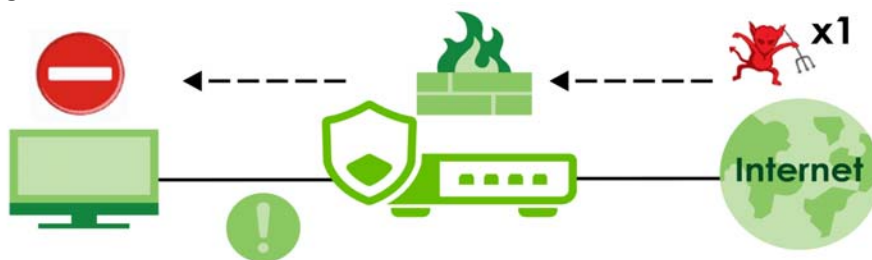
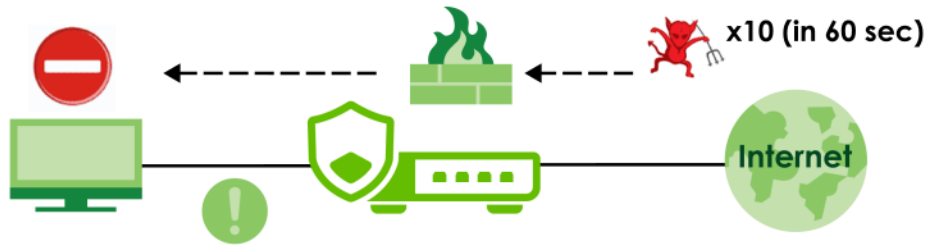

Figure 223 Rate Based Signatures Example



Applying Your IPS Configuration

Changes to the Zyxel Device's IPS settings affect new sessions, but not the sessions that already existed before you applied the new settings.

21.1.3 Before You Begin

Register for a trial IPS license in the **Licenses** screen. This gives you access to free signature updates. This is important as new signatures are created as new attacks evolve. When the trial license expires, purchase and enter a license key using the same screens to renew the license.

21.2 The IPS Screen

An IPS profile is a set of packet inspection signatures.

Click **Security Service > IPS** to open this screen. Use this screen to view signature information.

If a license has expired, you will see a reminder in this screen. You need to renew the license in order to keep using the feature. Click **Buy Now** to go to Marketplace to purchase a new license. Click **See Details** to go to the Zyxel web page to find more information on licenses for your Zyxel Device.

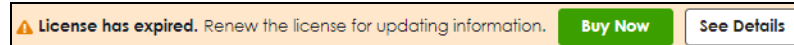

Note: You must register for the IPS signature service (at least the trial) before you can use it. See the **Licensing** screens.

Figure 224 Security Service > IPS

IPS
Allow List

General Settings

Enable

Statistics

Scan Mode

Mode Prevention Detection

Query Signatures

Name [Optional] Search

Signature ID [Optional]

Advanced Settings

Query Result

Active Inactive Log Action

#	Status	SID	Name	Severity	Classificati...	Platform	Service	Log	Action
No data									

Rows per page: 50 0 of 0 < 1 >

Rate Based Signatures

Edit Active Inactive Log Action

#	Status	SID	Name	Severity	Classificati...	Platform	Service	Period[s]	Count
1	Active	130009	FTP login failed attempt	high	Misc	Linux.FreeBSD	MISC	30	30
2	Active	130010	Telnet login failed attempt	high	Misc	Linux.FreeBSD	MISC	30	30
3	Active	130011	POP login brute force attempt	high	Misc	Linux.FreeBSD	MISC	5	99
4	Active	130012	MYSQL brute force root login attempt	high	Misc	Linux.FreeBSD	MISC	60	5
5	Active	130013	SMB named pipe bruteforce attempt	high	Misc	Linux.FreeBSD	MISC	1	99
6	Active	130014	Remote Desktop Protocol brute force atte...	high	Misc	Linux.FreeBSD	MISC	5	5
7	Active	130015	WordPress xmlrpc.php BruteForce in Progress	high	Misc	Linux.FreeBSD	MISC	60	5
8	Active	130016	SSH brute force login attempt	high	Misc	Linux.FreeBSD	MISC	60	5
9	Active	130668	TLSv1.2 POODLE CBC padding brute force ...	high	Misc	Linux.FreeBSD	MISC	10	100

Rows per page: 50 1-9 of 9 < 1 >

Signature Information

Current Version: 4.0.1.20220906.0

Release Date: 2022-09-06 10:10:00

Update Signatures

The following table describes the fields in this screen.

Table 178 Security Service > IPS

LABEL	DESCRIPTION
General Settings	
Enable	Click the switch to the right to activate the IPS feature which detects and prevents malicious or suspicious packets and responds instantaneously.
Statistics	Click the switch to the right to have the Zyxel Device collect IPS statistics. All of the statistics are erased if you restart the Zyxel Device or click Flush Data in Security Statistics > IPS .
Scan Mode	
Prevention	Select this to have the Zyxel Device perform a user-specified action when a stream of data matches a malicious signature.
Detection	Select this to have the Zyxel Device only create a log message when a stream of data matches a malicious signature.
Query Signatures	
Name	Type the name or part of the name of the signature(s) you want to find.
Signature ID	Type the ID or part of the ID of the signature(s) you want to find.
Advanced Settings	Configure these settings for more advanced queries.
Severity	<p>Search for signatures by severity level(s). Hold down the [Ctrl] key if you want to make multiple selections.</p> <p>These are the severities as defined in the Zyxel Device. The number in brackets is the number you use if using commands.</p> <p>Severe (16): These denote attacks that try to run arbitrary code or gain system privileges.</p> <p>High (8): These denote known serious vulnerabilities or attacks that are probably not false alarms.</p> <p>Medium (4): These denote medium threats, access control attacks or attacks that could be false alarms.</p> <p>Low (2): These denote mild threats or attacks that could be false alarms.</p> <p>Very-Low (1): These denote possible attacks caused by traffic such as Ping, trace route, ICMP queries etc.</p>
Classification	Search for signatures by attack type(s) (see Table 179 on page 361).
Platform	Search for signatures created to prevent intrusions targeting specific operating system(s).
Service	Search for signatures by IPS service group(s). See Table 180 on page 363 for group details.
Action	Search for signatures by the response the Zyxel Device takes when a packet matches a signature.
Activation	Search for activated and/or inactivated signatures here.
Log	Search for signatures by log option here.
Query Result	The results are displayed in a table showing the Status, SID, Name, Severity, Classification, Platform, Service, Log, and Action criteria as selected in the search. Click the SID column header to sort search results by signature ID.
Rate Based Signature	<p>IPS signatures identify traffic packets with suspicious malicious patterns. The Zyxel Device can then respond instantaneously according to the action you define.</p> <p>If you do not want the Zyxel Device to respond instantaneously for each suspicious packet detected, use rate based signatures to only respond after a number of occurrences (Count) within a certain time period (Period). See Section 21.1.2 on page 356 for more information on rate based signatures.</p>

Table 178 Security Service > IPS (continued)

LABEL	DESCRIPTION
Edit	Select an entry and click Edit to modify the entry's settings.
Active	To turn on an entry, select it and click Activate .
Inactive	To turn off an entry, select it and click Inactivate .
Log	To edit an item's log option, select it and use the Log icon. Select whether to have the Zyxel Device generate a log (log), log and alert (log alert) or neither (no) when a packet matches a signature.
Action	To edit what action the Zyxel Device takes when a packet matches a signature, select the entry and use the Action icon. none : Select this action to have the Zyxel Device take no action when a packet matches a signature. drop : Select this action to have the Zyxel Device silently drop a packet that matches a signature. Neither sender nor receiver are notified. reject : Select this action to have the Zyxel Device send a reset to both the sender and receiver when a packet matches the signature. If it is a TCP attack packet, the Zyxel Device will send a packet with a 'RST' flag to the receiver and sender. If it is an ICMP or UDP attack packet, the Zyxel Device will send an ICMP unreachable packet.
#	This is the entry's index number in the list.
Status	The activate (light bulb) icon is lit when the entry is active and dimmed when the entry is inactive.
SID	SID is the signature ID that uniquely identifies a signature. Click the SID header to sort signatures in ascending or descending order.
Name	This is the name of your rate-based signature. The name is the type of attack the Zyxel Device can identify.
Severity	This field displays signatures by severity level(s). Hold down the [Ctrl] key if you want to make multiple selections. These are the severities as defined in the Zyxel Device. The number in brackets is the number you use if using commands. Severe (5) : These denote attacks that try to run arbitrary code or gain system privileges. High (4) : These denote known serious vulnerabilities or attacks that are probably not false alarms. Medium (3) : These denote medium threats, access control attacks or attacks that could be false alarms. Low (2) : These denote mild threats or attacks that could be false alarms. Very-Low (1) : These denote possible attacks caused by traffic such as Ping, trace route, ICMP queries etc.
Classification	This field displays signatures by attack types (see Table 179 on page 361).
Platform	This field displays signatures created to prevent intrusions targeting specific operating system(s). Hold down the [Ctrl] key if you want to make multiple selections.
Service	This field displays signatures by IPS service group(s). See Table 180 on page 363 for group details. Hold down the [Ctrl] key if you want to make multiple selections.
Log	This field displays the log action the Zyxel Device takes when a packet matches a signature. log - The Zyxel Device generates a log. log an alert - The Zyxel Device generates a log and alerts the users. no - The Zyxel Device will neither generate a log nor alert the users.

Table 178 Security Service > IPS (continued)

LABEL	DESCRIPTION
Action	This field displays the response the Zyxel Device takes when a packet matches a signature. Hold down the [Ctrl] key if you want to make multiple selections. none: Select this action to have the Zyxel Device take no action when a packet matches a signature. drop: Select this action to have the Zyxel Device silently drop a packet that matches a signature. Neither sender nor receiver are notified. reject: Select this action to have the Zyxel Device send a reset to both the sender and receiver when a packet matches the signature. If it is a TCP attack packet, the Zyxel Device will send a packet with a 'RST' flag to the receiver and sender. If it is an ICMP or UDP attack packet, the Zyxel Device will send an ICMP unreachable packet.
Period (sec)	Type the length of time in seconds the event should occur a Count number of times to trigger an IPS Action . For example, Count is set to 5, and Period is set to 60. If the Zyxel Device detects more than 5 occurrences of malicious traffic in less than 60 seconds, then an IPS Action is triggered.
Count	Type the number of security events that need to occur within the defined Period in order to trigger an IPS Action . The allowed range is 1 to 300.
Block Period	This field displays the time period the attacker's IP will be blocked. Click on the number in this column to set the value from 0 to 86400 seconds. 0 means that the IP will not be blocked.
Signature Information	The following fields display information on the current signature set that the Zyxel Device is using.
Current Version	This field displays the IPS signature set version number. This number gets larger as the set is enhanced.
Update Signatures	Click this link to go to the screen you can use to download signatures from the update server.

Classifications

This table describes attack **Classifications** as categorized in the Zyxel Device.

Table 179 Attack Classifications

POLICY TYPE	DESCRIPTION
Any	Any attack includes all other kinds of attacks that are not specified in the policy such as password, spoof, hijack, phishing, and close-in.
Misc	Miscellaneous attacks takes advantage of vulnerable computer networks and web servers by forcing cache servers or web browsers into disclosing user-specific information that might be sensitive and confidential. The most common type of Misc. attacks are HTTP Response Smuggling, HTTP Response Splitting and JSON Hijacking.
Web-Attacks	Web attacks refer to attacks on web servers such as IIS (Internet Information Services).
Buffer Overflow	A buffer overflow occurs when a program or process tries to store more data in a buffer (temporary data storage area) than it was intended to hold. The excess information can overflow into adjacent buffers, corrupting or overwriting the valid data held in them. Intruders could run codes in the overflow buffer region to obtain control of the system, install a backdoor or use the victim to launch attacks on other devices.

Table 179 Attack Classifications (continued)

POLICY TYPE	DESCRIPTION
Backdoor/Trojan Horse	<p>A backdoor (also called a trapdoor) is hidden software or a hardware mechanism that can be triggered to gain access to a program, online service or an entire computer system. A Trojan horse is a harmful program that is hidden inside apparently harmless programs or data.</p> <p>Although a virus, a worm and a Trojan are different types of attacks, they can be blended into one attack. For example, W32/Blaster and W32/Sasser are blended attacks that feature a combination of a worm and a Trojan.</p>
Access Control	<p>Access control refers to procedures and controls that limit or detect access. Access control attacks try to bypass validation checks in order to access network resources such as servers, directories, and files.</p>
P2P	<p>Peer-to-peer (P2P) is where computing devices link directly to each other and can directly initiate communication with each other; they do not need an intermediary. A device can be both the client and the server. In the Zyxel Device, P2P refers to peer-to-peer applications such as e-Mule, e-Donkey, BitTorrent, iMesh, etc.</p>
IM	<p>IM (Instant Messenger) refers to chat applications. Chat is real-time, text-based communication between two or more users via networks-connected computers. After you enter a chat (or chat room), any room member can type a message that will appear on the monitors of all the other participants.</p>
Virus/Worm	<p>A computer virus is a small program designed to corrupt and/or alter the operation of other legitimate programs. A worm is a program that is designed to copy itself from one computer to another on a network. A worm's uncontrolled replication consumes system resources, thus slowing or stopping other tasks.</p>
BotNet	<p>A Botnet is a number of Internet computers that have been set up to forward transmissions including spam or viruses to other computers on the Internet though their owners are unaware of it. It is also a collection of Internet-connected programs communicating with other similar programs in order to perform tasks and participate in distributed Denial-Of-Service attacks.</p>
DoS-DDoS	<p>The goal of Denial of Service (DoS) attacks is not to steal information, but to disable a device or network on the Internet.</p> <p>A Distributed Denial of Service (DDoS) attack is one in which multiple compromised systems attack a single target, thereby causing denial of service for users of the targeted system.</p>
Scan	<p>A scan describes the action of searching a network for an exposed service. An attack may then occur once a vulnerability has been found. Scans occur on several network levels.</p> <p>A network scan occurs at layer-3. For example, an attacker looks for network devices such as a router or server running in an IP network.</p> <p>A scan on a protocol is commonly referred to as a layer-4 scan. For example, once an attacker has found a live end system, he looks for open ports.</p> <p>A scan on a service is commonly referred to a layer-7 scan. For example, once an attacker has found an open port, say port 80 on a server, he determines that it is a HTTP service run by some web server application. He then uses a web vulnerability scanner (for example, Nikto) to look for documented vulnerabilities.</p>
File Transfer	<p>File transfer is a protocol to transfer files over the Internet. An attack may then occur if you're transferring files over an unsecured connection. Personal data stored in the files uploaded can also be easily accessed by attackers if these files are not encrypted.</p>
Mail	<p>A Mail or email bombing attack involves sending several thousand identical messages to an electronic mailbox in order to overflow it, making it unusable.</p>
Stream Media	<p>A Stream Media attack occurs when a malicious network node downloads an overwhelming amount of media stream data that could potentially exhaust the entire system. This method allows users to send small requests messages that result in the streaming of large media objects, providing an opportunity for malicious users to exhaust resources in the system with little effort expended on their part.</p>

Table 179 Attack Classifications (continued)

POLICY TYPE	DESCRIPTION
Tunnel	A Tunneling attack involves sending IPv6 traffic over IPv4, slipping viruses, worms and spyware through the network using secret tunnels. This method infiltrates standard security measures through IPv6 tunnels, passing through IPv4 undetected. An external signal then triggers the malware to spring to life and wreak havoc from inside the network.
ACL	This attack is a violation of an ACL (Access Control List) rule. These are packet filter rules that check source, destination IP addresses / ports, and routing information in the packet.

IPS Service Groups

An IPS service group is a set of related packet inspection signatures.

Table 180 IPS Service Groups

WEB_PHP	WEB_MISC	WEB_IIS	WEB_FRONTPAGE
WEB_CGI	WEB_ATTACKS	TFTP	TELNET
SQL	SNMP	SMTP	RSERVICES
RPC	POP3	POP2	P2P
ORACLE	NNTP	NETBIOS	MYSQL
MISC_EXPLOIT	MISC_DDOS	MISC_BACKDOOR	MISC
IMAP	IM	ICMP	FTP
FINGER	DNS	n/a	

21.2.1 Query Example

This example shows a search with these criteria:

- Severity: Severe
- Classification Type: Misc
- Platform: Windows
- Service: Any
- Actions: Any

Figure 225 Query Example Search

Query Signatures

Name (Optional)

Signature ID (Optional)

Advanced Settings

Severity: Severe

Classification: Misc

Platform: Windows

Service: any

Action: any

Activation: any

Log: any

Query Result

Active Inactive Log Action

#	Status	SiD	Name	Severity	Classification	Platform	Service	Log	Action
1		111379	Microsoft Int...	severe	Misc	Windows	WEB	log	reject
2		112014	Multiple Gen...	severe	Misc	Windows	WEB	log	reject
3		117724	Microsoft Wl...	severe	Misc	Windows	EXPLOIT	log	reject
4		117744	Supervisor r...	severe	Misc	Windows	EXPLOIT	log	reject

Rows per page: 50 1 of 4

21.3 The Allow List Screen

Use this screen to exempt packets with these signatures from IPS inspection. The Zyxel Device will exclude incoming packets with the listed signature(s) from being intercepted and inspected.

Click **Security Services > IPS > Allow List** to display the following screen. Use **Add** to put a new item in the list or **Edit** to change an existing one or **Remove** to delete an existing entry.

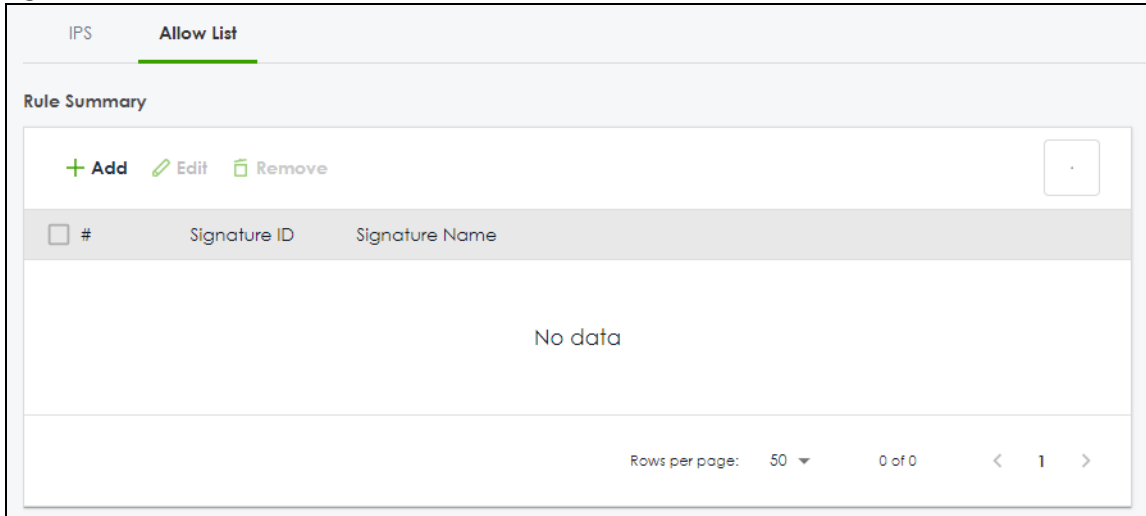
Figure 226 Security Service > IPS > Allow List

The following table describes the fields in this screen.

Table 181 Security Service > IPS > Allow List

LABEL	DESCRIPTION
Rule Summary	
Add	Click this to create a new entry.
Edit	Select an entry and click this to be able to modify it.
Remove	Select an entry and click this to delete it.
#	This is the entry's index number in the list.
Signature ID	This field displays the signature ID of this entry.
Signature Name	This field displays the signature name of this entry.

21.4 IPS Technical Reference

This section contains some background information on IPS.

Host Intrusions

The goal of host-based intrusions is to infiltrate files on an individual computer or server in with the goal of accessing confidential information or destroying information on a computer.

You must install a host IPS directly on the system being protected. It works closely with the operating system, monitoring and intercepting system calls to the kernel or APIs in order to prevent attacks as well as log them.

Disadvantages of host IPSs are that you have to install them on each device (that you want to protect) in your network and due to the necessarily tight integration with the host operating system, future operating system upgrades could cause problems.

Network Intrusions

Network-based intrusions have the goal of bringing down a network or networks by attacking computer(s), switch(es), router(s) or modem(s). If a LAN switch is compromised for example, then the whole LAN is compromised. Host-based intrusions may be used to cause network-based intrusions when the goal of the host virus is to propagate attacks on the network, or attack computer/server operating system vulnerabilities with the goal of bringing down the computer/server. Typical "network-based intrusions" are SQL slammer, Blaster, Nimda MyDoom etc.

Note: The Zyxel Device IPS protects your network against network-based intrusions.

CHAPTER 22

IP Exception

22.1 Overview

IP Exception allows incoming IP packets to bypass specific security services based on the packet's source or destination address. Bypassing a security service means the security service does not intercept nor inspect the packet.

For example, 192.168.100.100 is a trusted LAN computer. Add the IP address of the LAN computer to **Source** in **IP Exception** so the Zyxel Device will not perform security checking on traffic coming from this computer.

Figure 227 IP Exception Bypass Source Example



You can also add a trusted destination to bypass security checking. For example, 2.2.2.2 is a trusted web site. Add the IP address of the trusted web site to **Destination** in **IP Exception** so the Zyxel Device will not perform security checking when you access the web site to save resources.

Figure 228 IP Exception Bypass Destination Example

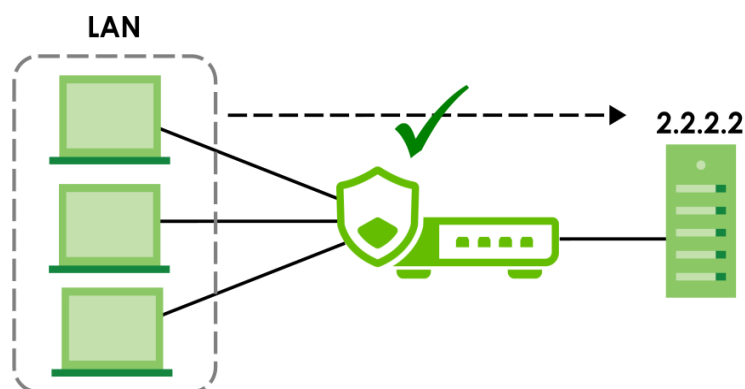

IP Exception supports bypassing the following security services:

- Anti-Malware
- URL Threat Filter
- IPS (Intrusion Prevention System)

- IP Reputation.
- DNS Threat Filter

22.2 The IP Exception Screen

Use this screen to view the IP exception list for the specified services. The Zyxel Device will not inspect incoming packets that match the listed source and destination IP address(es) with the specified services.

Click **Security Service > IP Exception** to display the following screen. Use **Add** to put a new entry in the list or **Edit** to change an existing one or **Remove** to delete an existing entry.

Figure 229 Security Service > IP Exception

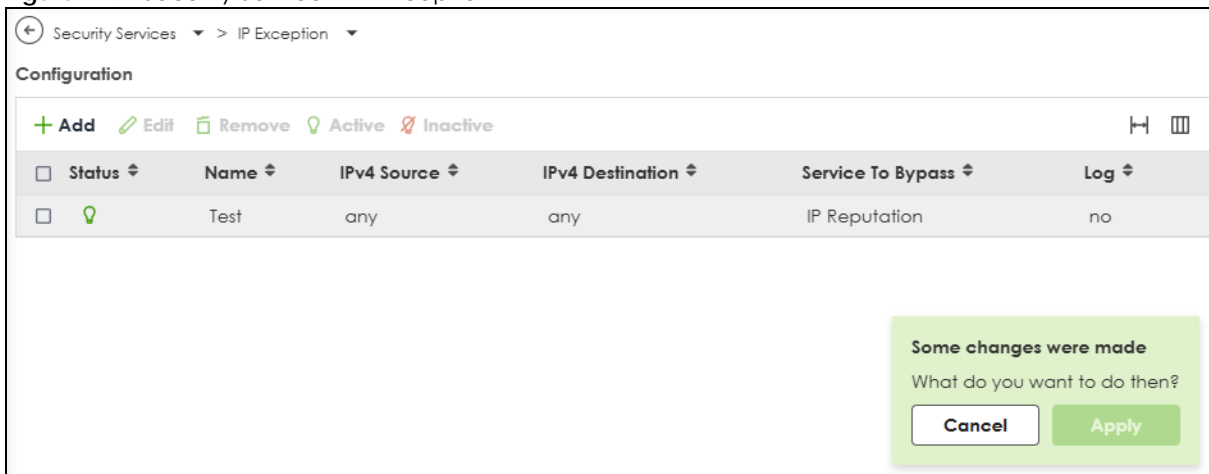

The following table describes the fields in this screen.

Table 182 Security Service > IP Exception

LABEL	DESCRIPTION
Configuration	
Add	Click this to create a new entry.
Edit	Select an entry and click this to be able to modify it.
Remove	Select an entry and click this to delete it.
Active	To turn off an entry, select it and click Active . The Status light changes accordingly.
Inactive	To turn off an entry, select it and click Inactive . The Status light changes accordingly.
Status	This icon is lit when the entry is active and dimmed when the entry is inactive.
Name	This field displays the descriptive name of this entry.
IPv4 Source	This field displays the source IP address (or address object) of incoming traffic. It displays any if there is no restriction on the source IP address.
IPv4 Destination	This field displays the destination IP address (or address object) of incoming traffic. It displays any if there is no restriction on the destination IP address.
Service to Bypass	This field displays which services will not inspect matched packets.
Log	This field displays if the Zyxel Device will generate a log when the incoming traffic is in the exception list.

Table 182 Security Service > IP Exception (continued)

LABEL	DESCRIPTION
Cancel	Click Cancel to return the screen to its last-saved settings.
Apply	Click Apply to save your changes back to the Zyxel Device.

22.2.1 The IP Exception Add/Edit Screen

Use this screen to add or edit entries of IPv4 address in the IP exception list.

Click **Security Service > IP Exception > Add/Edit** to display the following screen.

Figure 230 Security Service > IP Exception > Add/Edit

The following table describes the fields in this screen.

Table 183 Security Service > IP Exception > Add/Edit

LABEL	DESCRIPTION
Enable	Click this to the right to enable the rule on the Zyxel Device.
Name	Enter a descriptive name of this entry. You may use 2-31 alphanumeric characters, underscores (_), or dashes (-), but the first character cannot be a number. This value is case-sensitive.
Source	Select any or an address object of the source IP address for this entry. Select any so there's no restriction on the source IP address.
Destination	Select any or an address object of the destination IP address for this entry. Select any so there's no restriction on the destination IP address.
Log	The Zyxel Device does not inspect packets with the selected service if you select Yes . The Zyxel Device will also generate a log when the incoming traffic is in the exception list. Otherwise, select No .

Table 183 Security Service > IP Exception > Add/Edit (continued)

LABEL	DESCRIPTION
Service to Bypass	Selected services do not inspect packets that match source/destination criteria above. Non-selected services do inspect packets that match source/destination criteria above.
Apply	Click Apply to save your customized settings and exit this screen.
Cancel	Click Cancel to return the screen to its last-saved settings.

22.3 Example: Bypass a Website

You often access a website 1.1.1.1 that you are sure is safe. Every time you access the website, the packets sent by the website will be inspected by the Zyxel Device security services, such as anti-malware, content filter, reputation filter and app patrol.

This not only causes your web browser to take more time to load the website, but also takes up more Zyxel Device resources than necessary.

For example, you create an **IP Exception** profile for the website 1.1.1.1. IP exception allows incoming IP packets from the website 1.1.1.1 (**A**) to bypass specific security services. Bypassing a security service means the security service does not intercept nor inspect the packet.

Figure 231 Bypass Security Services Flow

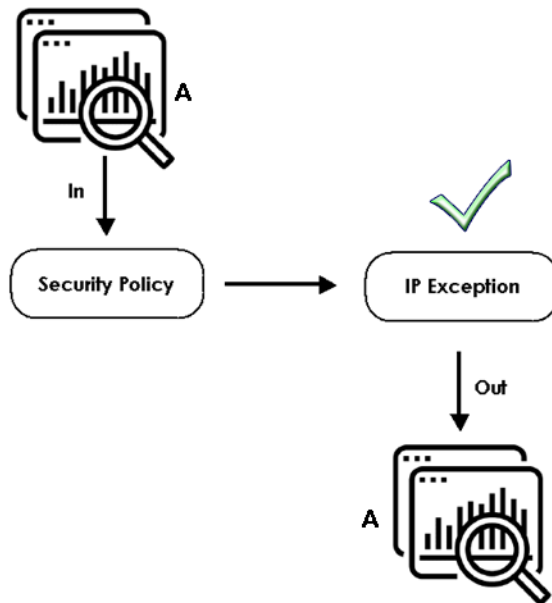

This example uses the parameters given below.

Table 184 Address Object Configuration Example

NAME	ADDRESS TYPE	IP ADDRESS
TrustedWebsite	Host	1.1.1.1

Table 185 IP Exception Configuration Example

NAME	SOURCE	DESTINATION	LOG	SERVICES TO BYPASS
ForTrustedWebsite	TrustedWebsite	Any	No	Anti-Malware URL Threat filter IPS IP Reputation DNS Threat Filter

- 1 Go to **Object > Address > Address** and click **Add**.
- 2 Configure the settings using the parameters given in [Table 184 on page 370](#). Click **Apply** to save your changes.

Configuration



Name

Description

Address Type

IP Address

- 3 Go to **Security Service > IP Exception** and click **Add**.
- 4 Configure the settings using the parameters given in [Table 185 on page 371](#). Click **Apply** to save your changes.

Configuration	
Name	ForTrustedWebsite
Source	TrustedWebsite 
Destination	any 
Log	no ▼
Service To Bypass	
<input checked="" type="checkbox"/>	Anti-Malware (Including Sandboxing)
<input checked="" type="checkbox"/>	URL Threat Filter
<input checked="" type="checkbox"/>	IPS
<input checked="" type="checkbox"/>	IP Reputation
<input checked="" type="checkbox"/>	DNS Threat Filter

CHAPTER 23

SSL Inspection

23.1 Overview

Secure Socket Layer (SSL) traffic, such as <https://www.google.com/> HTTPS, FTPs, POP3s, SMTPs, and so on, is encrypted, and cannot be inspected using Security Service profiles such as App Patrol, Web Filtering, Intrusion Prevention System (IPS), or Anti-Malware. The Zyxel Device uses SSL Inspection to decrypt SSL traffic, sends it to the Security Service engines for inspection, then encrypts traffic that passes inspection and forwards it to the destination server, such as Google.

An example process is shown in the following figure. User **U** sends a HTTPS request (SSL) to destination server **D**, via the Zyxel Device, **Z**. The traffic matches an SSL Inspection profile in a security policy, so the Zyxel Device decrypts the traffic using SSL Inspection. The decrypted traffic is then inspected by the Security Service profiles in the same security profile that matched the SSL Inspection profile. If all is OK, then the Zyxel Device re-encrypts the traffic using SSL Inspection and forwards it to the destination server **D**. SSL traffic could be in the opposite direction for other examples.

Figure 232 SSL Inspection Overview

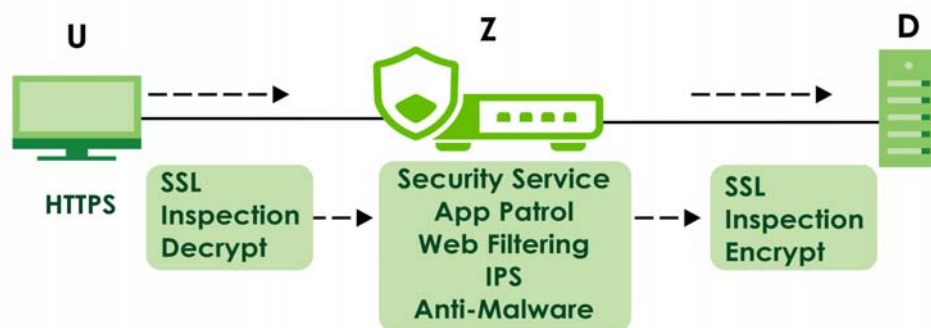

23.1.1 What You Can Do in this Chapter

- Use the **Security Service > SSL Inspection > Profile** screen ([Section 23.2 on page 374](#)) to view SSL Inspection profiles. Click the **Add** or **Edit** icon in this screen to configure the CA certificate, action and log in an SSL Inspection profile.
- Use the **Security Service > SSL Inspection > Exclude List** screens ([Section 23.3 on page 379](#)) to create a whitelist of destination servers to which traffic is passed through uninspected.
- Use the **Security Service > SSL Inspection > Certificate Update** screens ([Section 23.4 on page 380](#)) to update the latest certificates of servers using SSL connections to the Zyxel Device network

23.1.2 What You Need To Know

SSL Inspection supports the following TLS protocols and encryption algorithms

- TLS1.0 AES-CBC

- TLS 1.2 AES-CBC/AES-GCM
- TLS 1.3

SSL Inspection does not support the following:

- Compression Support
- Client Authentication

23.1.3 What You Can Do in this Chapter

- See **Object > Certificate > My Certificates** for information on creating certificates on the Zyxel Device.
- See **Security Statistics > SSL Inspection** to get usage data and easily add a destination server to the whitelist of exclusion servers.
- See **Security Policy > Policy Control > Policy** to bind an SSL Inspection profile to a traffic flow(s).

23.1.4 Before You Begin

- If you don't want to use the default Zyxel Device certificate, then create a new certificate in **Object > Certificate > My Certificates**.
- Decide what destination servers to which traffic is sent directly without inspection. This may be a matter of privacy and legality regarding inspecting an individual's encrypted session, such as financial websites. This may vary by locale.

23.2 The SSL Inspection Profile Screen

An SSL Inspection profile is a template with pre-configured certificate, action and log.

Click **Security Service > SSL Inspection > Profile** to open this screen.

Figure 233 Security Service > SSL Inspection > Profile

The screenshot displays the configuration interface for an SSL Inspection Profile. It is divided into three main sections: General Settings, Profile Management, and a notification area.

- General Settings:**
 - Server Signed Certificate Key Mode:** A dropdown menu currently showing 'rsa-1024'.
 - Statistics:** A green toggle switch that is turned on.
- Profile Management:**
 - Buttons for '+ Add', 'Edit', 'Remove', and 'Reference' are located at the top left.
 - A search bar labeled 'Search Insights' is on the top right.
 - A table with the following columns: Name, Description, CA Certificate, Reference, and Action.
 - The table content is empty, with the text 'No data' centered below the header.
- Notification:** A green box at the bottom right contains the text 'Some changes were made. What do you want to do then?' and two buttons: 'Cancel' and 'Apply'.

The following table describes the fields in this screen.

Table 186 Security Service > SSL Inspection > Profile

LABEL	DESCRIPTION
General Settings	
Server Signed Certificate Key Mode	<p>With SSL inspection, the Zyxel Device acts as a 'man-in-the-middle' between a client and a remote server, when the client and server are communicating using an SSL-encrypted session. Every time the client and server send data to each other, the Zyxel Device decrypts the sender's encrypted data, scans the plain data for threats, re-encrypts the data, and then sends the encrypted data to the receiver.</p> <ul style="list-style-type: none"> For outgoing sessions from the client to the remote server, the Zyxel Device creates a virtual server to decrypt data and a virtual client to re-encrypt data. For incoming sessions from the remote server to the client, the Zyxel Device creates a virtual client to decrypt data, and a virtual server to re-encrypt data. <p>To perform SSL Inspection for clients using SSL (HTTPS, SSH, SMTP) through the Zyxel Device, the Zyxel Device must check that the server's certificate with corresponding public key are valid and were issued by a Certificate Authority (CA) listed in the Zyxel Device's list of trusted CAs. According to the selected key mode RSA 1024, RSA 2048, ECDSA-RSA-1024 or ECDSA-RSA-2048, the Zyxel Device will construct the corresponding self-signed certificate for the virtual server.</p> <p>RSA is a public-key cryptosystem used for data encryption or signing messages. For data encryption, the encryption key is public and the decryption key is private. For signing messages, the signing key is private and the verification key is public. Elliptic Curve Cryptography (ECC) is a public-key cryptosystem based on elliptic curve theory, and more efficient than RSA. ECC allows smaller keys compared to RSA to provide equivalent security. For example, a 224-bit elliptic curve public key should provide comparable security to a 2048-bit RSA public key.</p> <ul style="list-style-type: none"> ECDSA-RSA-1024 indicates Zyxel Device support for clients that support both ECDSA-256 and RSA-1024 with ECDSA-256 having higher priority, that is ECDSA-256 is used by the virtual server, if a client supports both ECDSA-256 and RSA-1024. ECDSA-RSA-2048 indicates Zyxel Device support for clients that support both ECDSA-256 and RSA-2048 with ECDSA-256 having higher priority, that is ECDSA-256 is used by the virtual server, if a client supports both ECDSA-256 and RSA-2048. <p>Select a mode that the client's browser, FTP client, or mail client supports. The Zyxel Device will use different keys (cryptosystems) for each client according to the client's support list.</p> <p>For example, if there are three clients behind a Zyxel Device with the following key mode support:</p> <ul style="list-style-type: none"> Client 1 - RSA-1024 Client 2 - RSA-2048 and RSA-1024 Client 3 - ECDSA-256 and RSA-2048. <p>If you set the key mode to ECDSA-RSA-1024, then the following will be used by each client:</p> <ul style="list-style-type: none"> Client 1 - RSA-1024 Client 2 - RSA-1024 Client 3 - ECDSA-256. <p>If you set the key mode to ECDSA-RSA-2048, then the following will be used by each client:</p> <ul style="list-style-type: none"> Client 1 - sessions will not be processed (pass) by SSL inspection Client 2 - RSA-2048 Client 3 - ECDSA-256.
Statistics	Enable this to have the Zyxel Device collect SSL inspection statistics.
Profile Management	
Add	Click Add to create a new profile.

Table 186 Security Service > SSL Inspection > Profile (continued)

LABEL	DESCRIPTION
Edit	Select an entry and click this to be able to modify it.
Remove	Select an entry and click this to delete it.
References	Select an entry and click References to open a screen that shows which settings use the entry.
Action	Click this icon to apply the entry to a policy control rule. Go to the Security Policy > Policy Control screen to check the result.
#	This is the entry's index number in the list.
Name	This displays the name of the profile.
Description	This displays the description of the profile.
CA Certificate	This displays the CA certificate being used in this profile.
Reference	This displays the number of times an object reference is used in a profile.

23.2.1 Add/Edit SSL Inspection Profiles

Click **Security Service > SSL Inspection > Profile > Add** to create a new profile or select an existing profile and click **Edit** to change its settings.

Figure 234 Security Service > SSL Inspection > Profile > Add / Edit

Security Services > SSL Inspection > Profile

Configuration

Name
❗ It must begin with a letter and cannot exceed 31 characters. The valid characters are [0-9][a-z][A-Z][_.-].

Description

CA Certificate

SSL/TLS version
 Minimum Support

Log

Unsupported suit
 Action

Log

Untrusted cert chain
 Action

Log

Some changes were made
 What do you want to do then?

The following table describes the fields in this screen.

Table 187 Security Service > SSL Inspection > Profile > Add/Edit

LABEL	DESCRIPTION
Name	<p>This is the name of the profile. You may use 1-31 alphanumeric characters, underscores(_), or dashes (-), but the first character cannot be a number. This value is case-sensitive. These are valid, unique profile names:</p> <ul style="list-style-type: none"> • MyProfile • mYProfile • Mymy12_3-4 <p>These are invalid profile names:</p> <ul style="list-style-type: none"> • 1mYProfile • My Profile • MyProfile? • Whatalongprofilename123456789012
Description	<p>Enter additional information about this SSL Inspection entry. You can enter up to 60 characters (0-9a-zA-Z'()+:=?;!*#@\$_%~"). The first character must be a letter.</p>
CA Certificate	<p>This contains the default certificate and the certificates created in Object > Certificate > My Certificates. Choose the certificate for this profile.</p>
Email	<p>Use this button to have the Zyxel Device send the selected certificate to a valid email address. Click a certificate's row to select it and click Email to have the Zyxel Device mail that certificate. The following screen displays.</p> <div data-bbox="483 1024 1299 1486" style="border: 1px solid black; padding: 5px;"> <p>Email Certificate ✕</p> <p>Email Subject <input type="text"/></p> <p><small>❗ It cannot exceed 60 characters. The valid characters are [a-zA-Z0-9'()+:=?;!*#@\$_%~].</small></p> <p>Email To <input type="text"/> (Email Address)</p> <p><small>❗ It must be an Email address. It cannot exceed 83 characters.</small></p> <p>Email Content <input type="text"/></p> <p style="text-align: right;"><small>i</small></p> <p style="text-align: right;"><input type="button" value="Cancel"/> <input type="button" value="Send Email"/></p> </div>
Email Subject	<p>Enter a email subject text with 1-60 characters. It may consist of letters, numbers, and the following special characters: '()+:=?;!*#@\$_%~</p>
Email to	<p>Enter up to 83 characters for the email address of the receiver</p>
Email Content	<p>Enter the backup email body text using 1 to 251 single-byte characters, including 0-9a-zA-Z!"#\$%&'()*+,-./:;<=>@[\\]^_`{ } and spaces are allowed.</p> <p>? is not allowed.</p>
Cancel	<p>Click this to send the email to the email address you configured.</p>
Send Email	<p>Click this to close the screen.</p>
SSL/TLS version	
Minimum Support	<p>SSL / TLS connections using versions lower than this setting are blocked.</p>

Table 187 Security Service > SSL Inspection > Profile > Add/Edit (continued)

LABEL	DESCRIPTION
Log	<p>These are the log options for unsupported traffic that matches traffic bound to this policy:</p> <ul style="list-style-type: none"> • no: Select this option to have the Zyxel Device create no log for unsupported traffic that matches traffic bound to this policy. • log: Select this option to have the Zyxel Device create a log for unsupported traffic that matches traffic bound to this policy • log alert: An alert is an emailed log for more serious events that may need more immediate attention. They also appear in red in the Log & Report > Log/Events screen. Select this option to have the Zyxel Device send an alert for unsupported traffic that matches traffic bound to this policy.
Unsupported suit	
Action	<p>SSL Inspection supports these cipher suites:</p> <ul style="list-style-type: none"> • DES • 3DES • AES <p>Select to pass or block unsupported traffic (such as other cipher suites, compressed traffic, client authentication requests, and so on) that matches traffic bound to this policy here.</p>
Log	<p>These are the log options for unsupported traffic that matches traffic bound to this policy:</p> <ul style="list-style-type: none"> • no: Select this option to have the Zyxel Device create no log for unsupported traffic that matches traffic bound to this policy. • log: Select this option to have the Zyxel Device create a log for unsupported traffic that matches traffic bound to this policy • log alert: An alert is an emailed log for more serious events that may need more immediate attention. They also appear in red in the Log & Report > Log/Events screen. Select this option to have the Zyxel Device send an alert for unsupported traffic that matches traffic bound to this policy.
Untrusted cert chain	
Action	<p>A certificate chain is a certification process that involves the following certificates between the SSL/TLS server and a client. A certificate chain will fail if one of the following certificates is not correct.</p> <ul style="list-style-type: none"> • A certificate owned by a user • The certificate signed by a certification authority • A root certificate <p>Select to pass, inspect, or block an untrusted certification chain.</p>
Log	<p>These are the log options for unsupported traffic that matches traffic bound to this policy:</p> <ul style="list-style-type: none"> • no: Select this option to have the Zyxel Device create no log for unsupported traffic that matches traffic bound to this policy. • log: Select this option to have the Zyxel Device create a log for unsupported traffic that matches traffic bound to this policy • log alert: An alert is an emailed log for more serious events that may need more immediate attention. They also appear in red in the Log & Report > Log/Events screen. Select this option to have the Zyxel Device send an alert for unsupported traffic that matches traffic bound to this policy.
Apply	Click Apply to save your settings to the Zyxel Device, and return to the profile summary page.
Reset	Click Reset to return to the profile summary page without saving any changes.

23.3 Exclude List Screen

There may be privacy and legality issues regarding inspecting a user's encrypted session. The legal issues may vary by locale, so it's important to check with your legal department to make sure that it's OK to intercept SSL traffic from your Zyxel Device users.

To ensure individual privacy and meet legal requirements, you can configure an exclusion list to exclude matching sessions to destination servers. This traffic is not intercepted and is passed through uninspected.

Click **Security Services > SSL Inspection > Exclude List** to display the following screen. Use **Add** to put a new item in the list or **Edit** to change an existing one or **Remove** to delete an existing entry.

Figure 235 Security Service > SSL Inspection > Exclude List

The following table describes the fields in this screen.

Table 188 Security Service > SSL Inspection > Exclude List

LABEL	DESCRIPTION
General Settings	
Enable Logs for Exclude List	Click this to create a log for traffic that bypasses SSL Inspection.
Exclude List Address Settings	Use this part of the screen to create, edit, or delete items in the SSL Inspection exclusion list.
Add	Click this to create a new entry.
Edit	Select an entry and click this to be able to modify it.
Remove	Select a row and click this to delete it.

Table 188 Security Service > SSL Inspection > Exclude List (continued)

LABEL	DESCRIPTION
Content	<p>SSL traffic to a server to be excluded from SSL Inspection is identified by its certificate. Identify the certificate in one of the following ways:</p> <ul style="list-style-type: none"> The Common Name (CN) of the certificate. The common name of the certificate can be created in the System > Certificate > My Certificates screen. Type an IPv4 address. For example, type 192.168.1.35 Type an IPv4 in CIDR notation. For example, type 192.168.1.1/24 Type an IPv4 address range. For example, type 192.168.1.1-192.168.1.35 Type an email address. For example, type abc@zyxel.com.tw Type a DNS name or a common name (wildcard char: '*', escape char: '\'). Use up to 127 case-insensitive characters (0-9a-zA-Z`~!@#%&*()_-+[]{} \ :;.,<>/?). '*' can be used as a wildcard to match any string. Use '*' to indicate a single wildcard character.
Apply	Click Apply to save your settings to the Zyxel Device.
Cancel	Click Cancel to return to the profile summary page without saving any changes.

23.4 Certificate Update Screen

Use this screen to update the latest certificates of servers using SSL connections to the Zyxel Device network. User **U** sends an SSL request to destination server **D** (1), via the Zyxel Device, **Z**. **D** replies (2); **Z** intercepts the response from **D** and checks if the certificate has been previously signed. **Z** then replies to **D** (3) and also to **U** (4). **D**'s latest certificate is stored at myZyxel (**M**) along with other server certificates and can be downloaded to the Zyxel Device.

Figure 236 SSL Inspection Certificate Update Overview

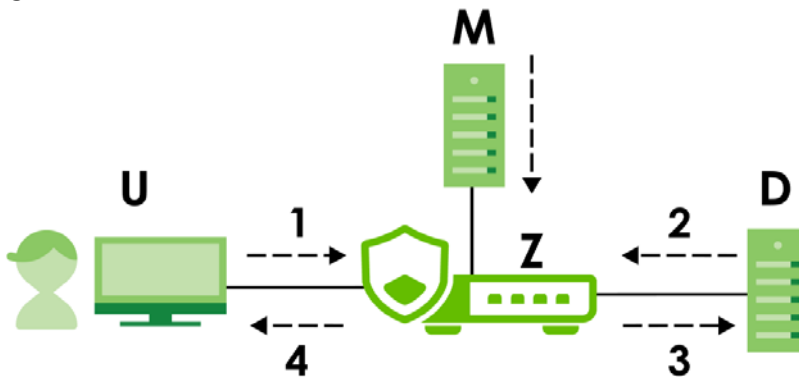

Click **Security Services > SSL Inspection > Certificate Update** to display the following screen.

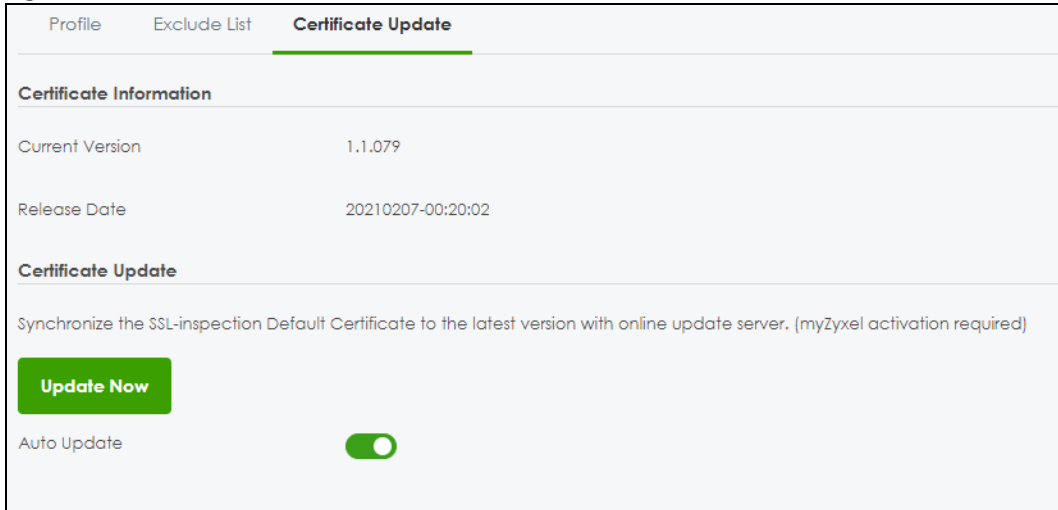
Figure 237 Security Services > SSL Inspection > Certificate Update

The following table describes the fields in this screen.

Table 189 Security Services > SSL Inspection > Certificate Update

LABEL	DESCRIPTION
Certificate Information	
Current Version	This displays the current certificate set version.
Released Date	This field displays the date and time the current certificate set was released.
Certificate Update	You should have Internet access and have activated SSL Inspection on the Zyxel Device at NCC.
Update Now	Click this button to download the latest certificate set (Windows, MAC OS X, and Android) from the Zyxel cloud server and update it on the Zyxel Device.
Auto Update	Select this to automatically have the Zyxel Device update the certificate set when a new one becomes available on the Zyxel cloud server.
Apply	Click Apply to save your settings to the Zyxel Device.
Cancel	Click Cancel to return to the profile summary page without saving any changes.

23.5 Install a CA Certificate in a Browser

Certificates used in SSL Inspection profiles should be installed in user web browsers. Do the following steps to install a certificate in a computer with a Windows operating system (PC). First, save the certificate to your computer.

- 1 Run the certificate manager using certmgr.msc.

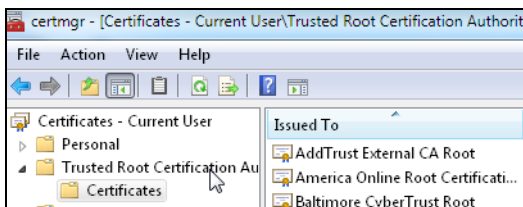

- 2 Go to **Trusted Root Certification Authorities > Certificates**.

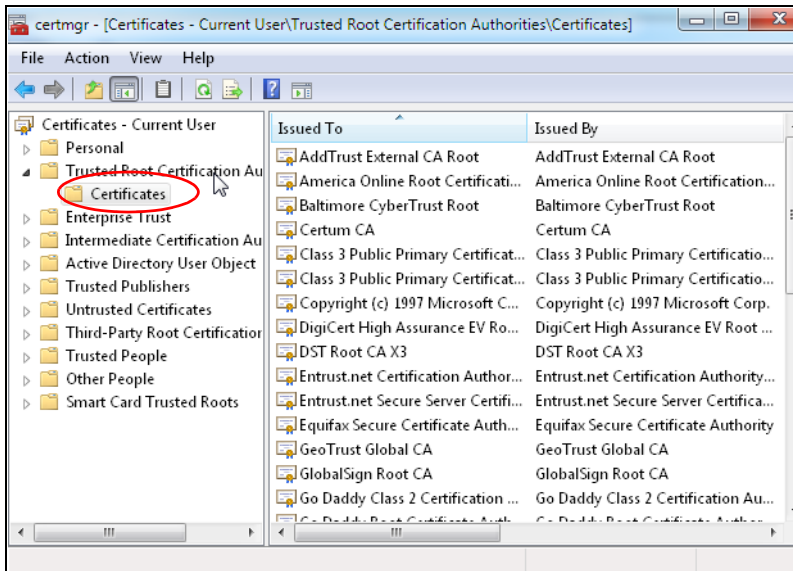

- 3 From the main menu, select **Action > All Tasks > Import** and run the **Certificate Import Wizard** to install the certificate on the PC.

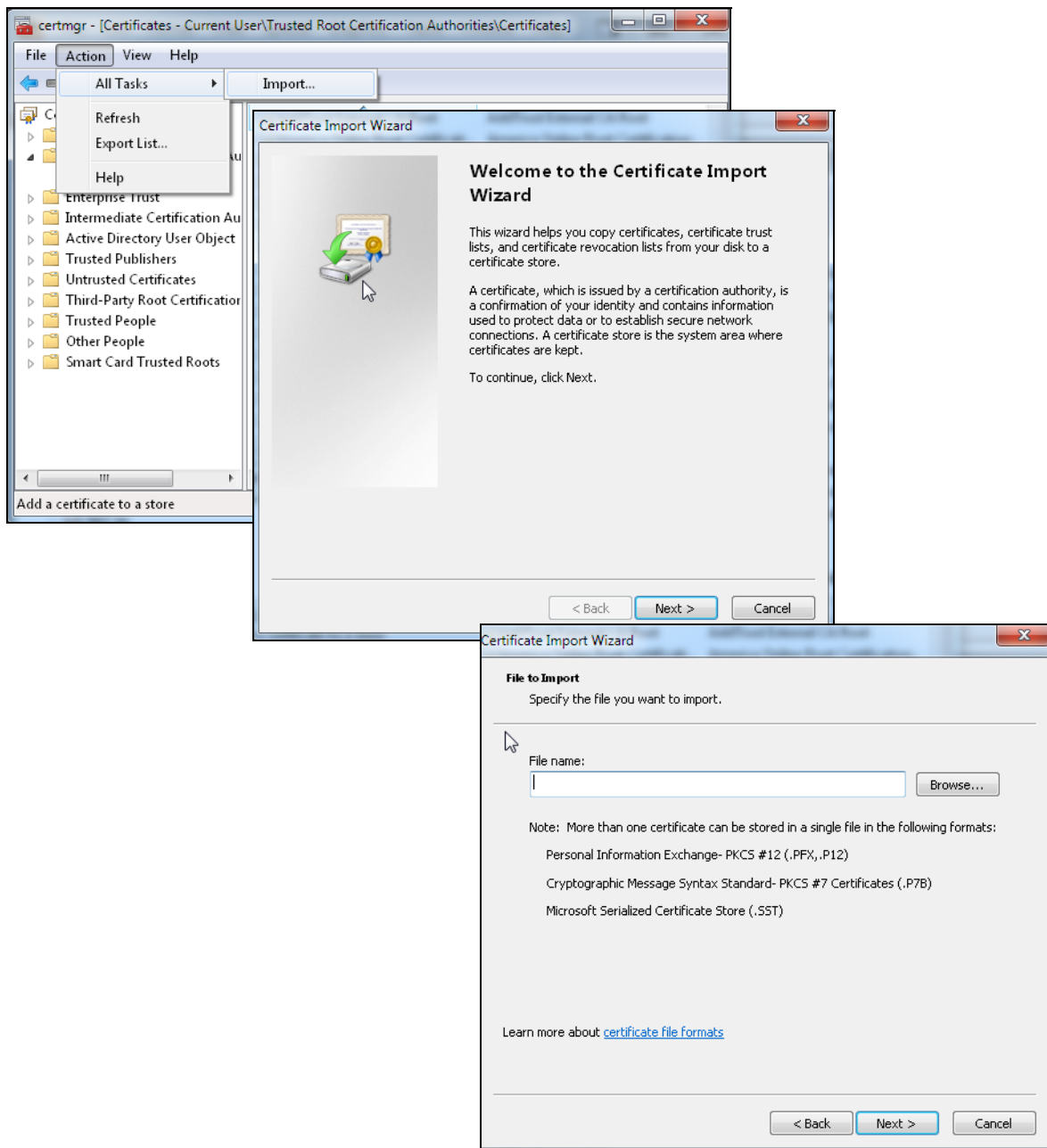

23.5.0.1 Firefox Browser

If you're using a Firefox browser, in addition to the above you need to do the following to import a certificate into the browser.

Click **Tools > Options > Advanced > Encryption > View Certificates**, click **Import** and enter the filename of the certificate you want to import. See the browser's help for further information.

CHAPTER 24

External Block Lists

24.1 Overview

Use these screens to use block IP, FQDN or URL list entries stored in a file on a web server that supports HTTP or HTTPS and is reachable from the Zyxel Device. The Zyxel Device will bypass checking by this feature (if enabled) and block incoming and outgoing packets from the block list entries in this file. In this way, different Zyxel Devices can use the same block list.

The external block list file must be in text format (*.txt) with each entry separated by a new line.

24.1.1 IP Reputation External Block List Screen

External block list entries can consist of single IPv4 / IPv6 IP addresses, IP address ranges, CIDR (Classless Inter-Domain Routing) entries such as 192.168.1.1/24, 2001:7300:3500::1/64. These are some examples for your reference only:

- Single IP 4.4.4.4
- CIDR 192.168.1.0/32
- IP range (1.2.3.4-1.2.3.100)

If the external block list file contains any invalid entries, the Zyxel Device will not use the file.

The external block list file can contain up to 50,000 entries. A warning message displays when the maximum is reached.

Go to **Security Services > External Block List > IP Reputation** to display the following screen.

If a license has expired, you will see a reminder in this screen. You need to renew the license in order to keep using the feature. Click **Buy Now** to go to Marketplace to purchase a new license. Click **See Details** to go to the Zyxel web page to find more information on licenses for your Zyxel Device.

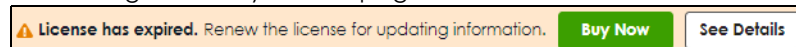

Figure 238 Security Services > External Block List > IP Reputation

Security Services > External Block List > IP Reputation

IP Reputation DNS Threat Filter/URL Threat Filter

External Block List

Enable

Profile Management

+ Add Remove Active Inactive

Status	Name	Source URL	Description
<input type="checkbox"/>	Test	https://www.example.com	

Signature Update

Synchronize the signature to the latest version with online update server.

Update Now

Auto Update

Every N Hours

Daily

Weekly

Note

Use Nebula Security Profile Sync (SPS) to centralize and sync security settings across your devices; visit the [Nebula](#) to configure and sync your devices now.





Some changes were made
What do you want to do then?
Cancel Apply

The following table describes the labels in this screen.

Table 190 Security Services > External Block List > IP Reputation

LABEL	DESCRIPTION
Enable	Select this to have the Zyxel Device block packets that come from the listed addresses in the block list file on the server.
Profile Management	
Add	Click this to create a new IP reputation external block list profile entry.
Remove	Select an entry and click this to delete it.
Active	To turn off an entry, select it and click Active . The Status light changes accordingly.
Inactive	To turn off an entry, select it and click Inactive . The Status light changes accordingly.
Status	This icon is lit when the entry is active and dimmed when the entry is inactive.

Table 190 Security Services > External Block List > IP Reputation (continued)

LABEL	DESCRIPTION
Name	Enter an identifying name for the block list file. You can use alphanumeric and ()+/:=?!*#@\$_%- characters, and it can be up to 60 characters long.
Source URL	Enter the exact file name, path and IP address of the server containing the block list file. For example, http://172.16.107.20/blocklist-files/myip-eb1.txt The server must be reachable from the Zyxel Device.
Description	Enter a description of the block list file. You can use alphanumeric and ()+/:=?!*#@\$_%- characters, and it can be up to 60 characters long.
Edit	Select an entry and click this icon to modify it. 
Remove	Select an entry and click this icon to delete it. 
Save Changes	Click this icon to save the changes in this row. 
Cancel Changes	Click this icon to cancel the changes in this row. 
Signature Update	New IP reputation signatures can be downloaded to the Zyxel Device periodically if you have subscribed for the IP reputation signatures service. You need to create a Zyxel account, register your Zyxel Device and then subscribe for IP reputation service in order to be able to download new signatures (see the Registration screens). Schedule signature updates for a day and time when your network is least busy to minimize disruption to your network.
Update Now	Click this to have the Zyxel Device immediately check for new signatures. If new signatures are found, they are then downloaded to the Zyxel Device.
Auto Update	Click this to have the Zyxel Device automatically check for new signatures regularly at the time and day specified. You should select a time when your network is not busy for minimal interruption.
Every N Hours	Select this to have the Zyxel Device check for new signatures every specified number of hours (N).
Daily	Select this to have the Zyxel Device check for new signatures every day at the specified time (am/pm). The time format is the 12 hour clock.
Weekly	Select this option to have the Zyxel Device check for new signatures once a week on the day and at the time (am/pm) specified.
Apply	Click Apply to save your changes back to the Zyxel Device.
Cancel	Click Cancel to return the screen to its last-saved settings.

24.1.2 DNS / URL Threat Filter External Block List Screen

Use this screen to use block list entries stored in a file on a web server that supports HTTP or HTTPS. The Zyxel Device will block incoming and outgoing packets from the block list entries in this file. Supported formats are:

- hostname (www.google.com)
- URL http - check full url (http://xxx.yyy.zzz/qqq/wwwww)
- URL https - only check hostname (https://xxx.)

Please note the following:

- The external block list file must be in text format (*.txt) with each entry separated by a new line.
- External block list entries can consist of a complete URL or a hostname and may contain wildcards. There are some examples for your reference only:
 - https://www.zyxel.com/products_services/smb.shtml?t=s (complete URL)
 - www.zyxel.com (hostname)
 - *.zyxel.* (hostname with wildcards)
- If the external block list file contains any invalid entries, the Zyxel Device will not use the file.
- The external block list file can contain up to 50,000 entries. A warning message displays when the maximum is reached.





Figure 239 Security Services > External Block List > DNS / URL Threat Filter

The following table describes the labels in this screen.

Table 191 Security Services > External Block List > DNS / URL Threat Filter

LABEL	DESCRIPTION
Enable	Select this check box to have the Zyxel Device automatically block packets that come from the listed addresses in the block list file on the server.
Profile Management	
Add	Click this to create a new DNS/URL threat filter external block list entry.
Remove	Select an entry and click this to delete it.

Table 191 Security Services > External Block List > DNS / URL Threat Filter (continued)

LABEL	DESCRIPTION
Name	Enter an identifying name for the block list file. You can use alphanumeric and ()+/:=?!*#@\$_%- characters, and it can be up to 60 characters long.
Source	Enter the exact file name, path and IP address of the server containing the block list file. For example, http://172.16.107.20/blocklist-files/myip-eb1.txt The server must be reachable from the Zyxel Device.
Description	Enter a description of the block list file. You can use alphanumeric and ()+/:=?!*#@\$_%- characters, and it can be up to 60 characters long.
Edit	Select an entry and click this icon to modify it. 
Remove	Select an entry and click this icon to delete it. 
Save Changes	Click this icon to save the changes in this row. 
Cancel Changes	Click this icon to cancel the changes in this row. 
Signature Update	New IP reputation signatures can be downloaded to the Zyxel Device periodically if you have subscribed for the IP reputation signatures service. You need to create a Zyxel account, register your Zyxel Device and then subscribe for IP reputation service in order to be able to download new signatures (see the Registration screens). Schedule signature updates for a day and time when your network is least busy to minimize disruption to your network.
Update Now	Click this to have the Zyxel Device immediately check for new signatures. If new signatures are found, they are then downloaded to the Zyxel Device.
Auto Update	Click this to have the Zyxel Device automatically check for new signatures regularly at the time and day specified. You should select a time when your network is not busy for minimal interruption.
Every N Hours	Select this to have the Zyxel Device check for new signatures every specified number of hours (N).
Daily	Select this to have the Zyxel Device check for new signatures every day at the specified time (am/pm).
Weekly	Select this option to have the Zyxel Device check for new signatures once a week on the day and at the time (am/pm) specified.
Apply	Click Apply to save your changes back to the Zyxel Device.
Cancel	Click Cancel to return the screen to its last-saved settings.

CHAPTER 25

User & Authentication

25.1 User/Group Overview

This section describes how to set up user accounts, user groups, and user settings for the Zyxel Device. You can also set up rules that control when users have to log in to the Zyxel Device before the Zyxel Device routes traffic for them.

- The **User** screen (see [Section 25.1.2 on page 390](#)) provides a summary of all user accounts.
- The **Group** screen (see [Section 25.1.4 on page 395](#)) provides a summary of all user groups. In addition, this screen allows you to add, edit, and remove user groups. User groups may consist of access users and other user groups. You cannot put admin users in user groups.
- The **Setting** screen (see [Section 25.1.5 on page 397](#)) controls default settings, login settings, lockout settings, and other user settings for the Zyxel Device. You can also use this screen to specify when users must log in to the Zyxel Device before it routes traffic for them.

25.1.1 What You Need To Know

User Account

A user account defines the privileges of a user logged into the Zyxel Device. User accounts are used in security policies and application patrol, in addition to controlling access to configuration and services in the Zyxel Device.

User Types

These are the types of user accounts the Zyxel Device uses.

Table 192 Types of User Accounts

TYPE	ABILITIES	LOGIN METHOD(S)
Admin Users		
admin	Change the Zyxel Device settings (web, CLI)	WWW, SSH, FTP, Console
viewer	Look at the Zyxel Device settings (web, CLI) Perform basic diagnostics (CLI)	WWW, SSH, Console
Access Users		
user	Access network services	WWW
ext-user	External user account	WWW

Ext-User Accounts

Set up an **ext-user** account if the user is authenticated by an external server and you want to set up specific policies for this user in the Zyxel Device. If you do not want to set up policies for this user, you do not have to set up an **ext-user** account.

All **ext-user** users should be authenticated by an external server, such as AD, LDAP or RADIUS. If the Zyxel Device tries to use the local database to authenticate an **ext-user**, the authentication attempt always fails. (This is related to AAA servers and authentication methods, which are discussed in those chapters in this guide.)

Note: If the Zyxel Device tries to authenticate an **ext-user** using the local database, the attempt always fails.

Once an **ext-user** user has been authenticated, the Zyxel Device tries to get the user type (see [Table 192 on page 389](#)) from the external server. If the external server does not have the information, the Zyxel Device sets the user type for this session to **User**.

For the rest of the user attributes, such as reauthentication time, the Zyxel Device checks the following places, in order.

- 1 User account in the remote server.
- 2 User account (Ext-User) in the Zyxel Device.
- 3 Default user account for AD users (**ad-users**), LDAP users (**ldap-users**) or RADIUS users (**radius-users**) in the Zyxel Device.

User Groups

User groups may consist of user accounts or other user groups. Use user groups when you want to create the same rule for several user accounts, instead of creating separate rules for each one.

Note: You cannot put access users and admin users in the same user group.

Note: You cannot put the default **admin** account into any user group.

The sequence of members in a user group is not important.

25.1.2 User/Group User Summary Screen

The **User** screen provides a summary of all user accounts. To access this screen, click **User & Authentication > User/Group > User**.

Figure 240 User & Authentication > User/Group > User

Local Administrator					
Name	User Type	Description	Created Date	Password Changed Date	Reference
admin	admin		Built-in	2023-04-28 02:12	0
LimitedAccount	viewer		2023-04-28 03:04	2023-04-28 03:04	0

User					
Name	User Type	Description	Created Date	Password Changed Date	Reference
radius-users	ext-user		Built-in	-	0
ldap-users	ext-user		Built-in	-	0
ad-users	ext-user		Built-in	-	0

The following table describes the labels in this screen.

Table 193 User & Authentication > User/Group > User

LABEL	DESCRIPTION
Add	Click this to create a new entry.
Edit	Double-click an entry or select it and click Edit to open a screen where you can modify the entry's settings.
Remove	To remove an entry, select it and click Remove . The Zyxel Device confirms you want to remove it before doing so.
Local Administrator	Use this table to view and configure the Zyxel Device admin accounts.
Name	This field displays the user name of each user.
User Type	This field displays the admin accounts the Zyxel Device uses. Admin accounts are users that can look at and change the configuration of the Zyxel Device
Description	This field displays the description for each user.
Created Date	This field displays the date the account is created. This field displays - if the account is created before the Zyxel Device upgrades firmware to version 5.10 or later.
Password Changed Date	This field displays the last time the user changed the account password.
Reference	This displays the number of times an object reference is used in a profile.
User	Use this table to configure the Zyxel Device: <ul style="list-style-type: none"> User accounts. Ext-user accounts.
Name	This field displays the user name of each user.
User Type	This field displays the types of user accounts the Zyxel Device uses: <ul style="list-style-type: none"> user - this user has access to the Zyxel Device's services and can also browse user-mode commands (CLI). ext-user - this user account is maintained in a remote server, such as RADIUS or LDAP. See Ext-User Accounts on page 390 for more information about this type.
Description	This field displays the description for each user.
Created Date	This field displays the date the account is created.

Table 193 User & Authentication > User/Group > User (continued)

LABEL	DESCRIPTION
Password Changed Date	This field displays the last time the user changes the account password.
Reference	This displays the number of times an object reference is used in a profile.

25.1.3 User Add/Edit Screen

The **User Add/Edit General** screen allows you to create a new user account or edit an existing one.

25.1.3.1 Rules for User Names

Enter a user name from 1 to 30 characters.

The user name can only contain the following characters:

- Alphanumeric A-z 0-9 (there is no unicode support)
- _ [underscores]
- - [dashes]
- . [period]
- @ [at]

The first character must be alphabetical (A-Z a-z), an underscore (_), or a dash (-). Other limitations on user names are:

- User names are case-sensitive. If you enter a user 'bob' but use 'BOB' when connecting via CIFS or FTP, it will use the account settings used for 'BOB' not 'bob'.
- User names have to be different than user group names.

To access this screen, go to the **User** screen, and click either the **Add** icon or an **Edit** icon.

Figure 241 User & Authentication > User/Group > User > Add/Edit (Local Administrator)

Profile Management

*User Name: Adam

User Type: Admin

*Password: [Redacted]

Retype: [Redacted]

Description: [Redacted]

Email 1: [Redacted]

Email 2: [Redacted]

Mobile Number: [Redacted]

Authentication Timeout Settings: Use Default Settings Use Manual Settings

Lease Time	1440	minutes
Reauthentication Time	1440	minutes

Two-factor Authentication

Enable Two-Factor Authentication for Admin Access:

Some changes were made
What do you want to do then?

Cancel Apply

Figure 242 User & Authentication > User/Group > User > Add/Edit (User)

The following table describes the labels in this screen.

Table 194 User & Authentication > User/Group > User > Add/Edit

LABEL	DESCRIPTION
User Name	Type the user name for this user account. You may use 1-30 alphanumeric characters, periods (.), at (@), underscores(_), or dashes (-), but the first character cannot be a number. This value is case-sensitive. User names have to be different than user group names, and some words are reserved. See Section 25.1.3.1 on page 392 .
User Type	<p>Select the type of user account the Zyxel Device uses for the Local Administrator account from the drop-down list box.</p> <ul style="list-style-type: none"> Admin- this user can configure the Zyxel Device settings using the web configurator or CLI. Viewer- this user can only view the Zyxel Device settings using the web configurator and perform basic diagnostics for troubleshooting using the command line interface (CLI). <p>Select the type of user account the Zyxel Device uses for the User account from the drop-down list box:</p> <ul style="list-style-type: none"> User - this user has access to the Zyxel Device's services and can also browse user-mode commands (CLI). External User - this user account is maintained on a remote server, such as RADIUS or LDAP. See Ext-User Accounts on page 390 for more information about this type.
Password	<p>This field is not available if you select the External User type.</p> <p>Enter a password consisting of 4 to 63 characters for this user account, including [0-9] [a-z] [A-Z] [' () { } < > ^ ' + / : ! * # @ & = \$ \ . ~ % , ; - "] . If the Password Policy is enabled in the User & Authentication > User/Group > Setting screen, the password criteria might be different. See Section 25.1.5.1 on page 400 for more information.</p>

Table 194 User & Authentication > User/Group > User > Add/Edit (continued)

LABEL	DESCRIPTION
Retype	This field is not available if you select the External User type.
Description	Enter the description of each user, if any. You can use 1 to 30 single-byte characters, including 0-9a-zA-Z!"#\$%&'()*+,-/;:=?@_&.<>[\]{ ^' are not allowed. Default descriptions are provided.
Email	Type one or more valid email addresses for this user so that email messages can be sent to this user if required. A valid email address must contain the @ character. For example, this is a valid email address: abc@example.com.
Mobile Number	Type a valid mobile telephone number for this user so that SMS messages can be sent to this user if required. A valid mobile telephone number can be up to 20 characters in length, including the numbers 1-9 and the following characters in the square brackets [+*#()-].
Authentication Timeout Settings	If you want the system to use default settings, select Use Default Settings . If you want to set authentication timeout to a value other than the default settings, select Use Manual Settings then fill your preferred values in the fields that follow.
Lease Time	If you select Use Default Settings in the Authentication Timeout Settings field, the default lease time is shown. If you select Use Manual Settings , you need to enter the number of minutes this user has to renew the current session before the user is logged out. You can specify 1 to 1440 minutes. You can enter 0 to make the number of minutes unlimited. Admin users renew the session every time the main screen refreshes in the Web Configurator. Access users can renew the session by clicking the Renew button on their screen. If you allow access users to renew time automatically (see Section 25.1.5 on page 397), the users can select this check box on their screen as well. In this case, the session is automatically renewed before the lease time expires.
Reauthentication Time	If you select Use Default Settings in the Authentication Timeout Settings field, the default reauthentication time is shown. If you select Use Manual Settings , you need to type the number of minutes this user can be logged into the Zyxel Device in one session before the user has to log in again. You can specify 1 to 1440 minutes. You can enter 0 to make the number of minutes unlimited. Unlike Lease Time , the user has no opportunity to renew the session without logging out.
Enable Two-Factor Authentication for Admin Access	This field is available when you are editing a local administrator account. Enable this to require double-layer security to access a secured network behind the Zyxel Device via the Web Configurator.
Apply	Click Apply to save your customized settings and exit this screen.
Cancel	Click Cancel to return the screen to its last-saved settings.

25.1.4 User/Group Group Summary Screen

User groups consist of access users and other user groups. You cannot put admin users in user groups. The **Group** screen provides a summary of all user groups. In addition, this screen allows you to add, edit, and remove user groups. To access this screen, login to the Web Configurator, and click **User & Authentication > User/Group > Group**.

Figure 243 User & Authentication > User/Group > Group



The following table describes the labels in this screen. See [Section 25.1.4.1 on page 396](#) for more information as well.

Table 195 User & Authentication > User/Group > Group

LABEL	DESCRIPTION
Add	Click this to create a new entry.
Edit	Double-click an entry or select it and click Edit to open a screen where you can modify the entry's settings.
Remove	To remove an entry, select it and click Remove . The Zyxel Device confirms you want to remove it before doing so. Removing a group does not remove the user accounts in the group.
Group Name	This field displays the name of each user group.
Description	This field displays the description for each user group.
Members	This field lists the members in the user group. Each member is separated by a comma.
Reference	This displays the number of times an object reference is used in a profile.

25.1.4.1 Group Add/Edit Screen

The **Group Add/Edit** screen allows you to create a new user group or edit an existing one. To access this screen, go to the **Group** screen, and click either the **Add** icon or an **Edit** icon.

Figure 244 User & Authentication > User/Group > Group > Add

User & Authentication > User/Group > Group > Add

Group Members

Name

! It must begin with a letter and cannot exceed 31 characters. The valid characters are [0-9][a-z][A-Z][_.-].

Description

Member List

+ Add Object

Available

Filter items...

Select All

Object

ad-users

admin

koala

ldap-users

radius-users

zyxel_vpn

Group

koala_usergroup

Member

Filter items...

Select All

Object

Group

Some changes were made

What do you want to do then?

Cancel **Apply**

The following table describes the labels in this screen.

Table 196 User & Authentication > User/Group > Group > Add

LABEL	DESCRIPTION
Name	Type the name for this user group. You may use 2-30 alphanumeric characters, underscores(_), or dashes (-), but the first character cannot be a number. This value is case-sensitive. User group names have to be different than user names.
Description	Enter the description of the user group, if any. You can use up to 60 characters, punctuation marks, and spaces.
Add Object	Click this button to create a new user account.
Search	Type an item in the search box, then click this to display all user accounts in the table below according to the item you typed.
Select All	Select this to select all user accounts and user groups in the table.
Member List	This list displays the names of the users and user groups that have been added to the user group. The order of members is not important. Select items from the list on the left that you want to be members and move them to the list on the right. Move any members you do not want included to the list on the left.
Apply	Click Apply to save your customized settings and exit this screen.
Cancel	Click Cancel to return the screen to its last-saved settings.

25.1.5 User/Group Setting Screen

The **Setting** screen controls default settings, login settings, lockout settings, and other user settings for the Zyxel Device. You can also use this screen to specify when users must log in to the Zyxel Device before it routes traffic for them.

To access this screen, login to the Web Configurator, and click **User & Authentication > User/Group > Setting**.

Figure 245 User & Authentication > User/Group > Setting

User & Authentication > User/Group > Setting

User Group **Setting**

User Default Setting

Default Authentication Timeout Settings

User Type	Lease Time	Reauthentication Time
admin	1440	1440
viewer	1440	1440
user	1440	1440
ext_user	1440	1440

Miscellaneous Settings

Auto renew lease time Enable

Admin User Type Login Security

Force change password Enable

Period (1-365 days)

Password Policy

Enabled	Name	Setting
<input type="checkbox"/>	Admin	
<input type="checkbox"/>	User	

User Logon Settings

Limit simultaneous admin logons Enable

Maximum number per admin account (1-500)

Limit simultaneous access logons Enable

Maximum number per access account (1-500)

Reach maximum number per account Block Remove previous user and login

User Lockout Settings

Limit logon retry Enable

Maximum retry count (1-99)

Lockout period (1-65535 minutes)

Some changes were made
What do you want to do then?

The following table describes the labels in this screen.

Table 197 User & Authentication > User/Group > Setting

LABEL	DESCRIPTION
User Default Settings	
Default Authentication Timeout Settings	These authentication timeout settings are used by default when you create a new user account. They also control the settings for any existing user accounts that are set to use the default settings. You can still manually configure any user account's authentication timeout settings.
Edit	Select an entry and click this icon to modify it.
Save Changes	Click this icon to save the changes in this row.

Table 197 User & Authentication > User/Group > Setting (continued)

LABEL	DESCRIPTION
Cancel Changes	Click this icon to cancel the changes in this row. 
User Type	These are the kinds of user account the Zyxel Device supports. <ul style="list-style-type: none"> admin - this user can look at and change the configuration of the Zyxel Device user - this user has access to the Zyxel Device's services but cannot look at the configuration ext-user - this user account is maintained in a remote server, such as RADIUS or LDAP. See Ext-User Accounts on page 390 for more information about this type. viewer - this user can look at the configuration of the Zyxel Device
Lease Time	This is the default lease time in minutes for each type of user account. It defines the number of minutes the user has to renew the current session before the user is logged out. Admin users renew the session every time the main screen refreshes in the Web Configurator. Access users can renew the session by clicking the Renew button on their screen. If you allow access users to renew time automatically (see Section 25.1.5 on page 397), the users can select this check box on their screen as well. In this case, the session is automatically renewed before the lease time expires. To edit the lease time, enter the number of minutes this type of user account has to renew the current session before the user is logged out. You can specify 1 to 1440 minutes. You can enter 0 to make the number of minutes unlimited.
Reauthentication Time	This is the default reauthentication time in minutes for each type of user account. It defines the number of minutes the user can be logged into the Zyxel Device in one session before having to log in again. Unlike Lease Time , the user has no opportunity to renew the session without logging out. To edit the reauthentication time, enter the number of minutes this type of user account can be logged into the Zyxel Device in one session before the user has to log in again. You can specify 1 to 1440 minutes. You can enter 0 to make the number of minutes unlimited.
Miscellaneous Settings	
Auto renew lease time	Enable to let access users renew lease time automatically.
Admin User Type Login Security	
Force change password	Enable to force local admin type users to change their password after the specified period of time when they log into the Zyxel Device. If the Password Policy is enabled, you will then be required to change your password to comply with the new rules.
Period	Enter how often users must change their password when they log into the Zyxel Device. You can choose from once a day to once a year.
Password Policy	
Enabled	Enable this to set minimum length and character rules for the web configurator login password. The new password rules will take effect the next time you change your password.
Name	This field displays the user name of the account.
Setting	Click this to set minimum length and character rules for the web configurator login password. See Section 25.1.5.1 on page 400 for more information.
User Logon Settings	
Limit simultaneous admin logons enable	Enable to set a limit on the number of simultaneous logins by admin users. If you do not select this, admin users can login as many times as they want at the same time using the same or different IP addresses.

Table 197 User & Authentication > User/Group > Setting (continued)

LABEL	DESCRIPTION
Maximum number per admin account	Type the maximum number of simultaneous logins by each admin user.
Limit the simultaneous access logons enable	Select this check box if you want to set a limit on the number of simultaneous logins by non-admin users. If you do not select this, access users can login as many times as they want as long as they use different IP addresses.
Maximum number per access account	Type the maximum number of simultaneous logins by each access user.
Reach maximum number per account	Set the action the Zyxel Device will take when the limit you set for the numbers of simultaneous logins by admin users or non-admin users has exceeded. Select Block to have the Zyxel Device block any accounts that try to log in. Select Remove previous user and login to have the Zyxel Device remove the most recently login account
User Lockout Settings	
Enable logon retry limit enable	Enable to set a limit on the number of times each user can login unsuccessfully (for example, wrong password) before the IP address is locked out for a specified amount of time.
Maximum retry count	This field is effective when Enable logon retry limit is checked. Type the maximum number of times each user can login unsuccessfully before the IP address is locked out for the specified lockout period . The number must be between 1 and 99.
Lockout period	This field is effective when Enable logon retry limit is checked. Type the number of minutes the user must wait to try to login again, if logon retry limit is enabled and the maximum retry count is reached. This number must be between 1 and 65,535 (about 45.5 days).
Apply	Click Apply to save the changes.
Cancel	Click Cancel to return the screen to its last-saved settings.

25.1.5.1 Password Policy Setting Screen

The **Password Policy Setting** screen allows you to set minimum length and character rules for the web configurator login password. To access this screen, go to the **User & Authentication > User/Group > Setting** screen, and click the **Setting** icon under **Password Policy**.

Figure 246 User & Authentication > User/Group > Setting > Password Policy Setting

The screenshot shows a dialog box titled "Admin Policy" with a close button (X) in the top right corner. Under the "Password Complexity" section, there are five settings, each with a green toggle switch:

- Enable:
- Minimum password length: 5 (4-20)
- At least one upper case:
- At least one digit:
- At least one special character:

At the bottom of the dialog box, there are two buttons: "Cancel" and "OK".

The following table describes the labels in this screen.

Table 198 User & Authentication > User/Group > Setting > Password Policy Setting

LABEL	DESCRIPTION
Enable	Enable this to set the following rules on the web configurator login password.
Minimum password length	Enable this and enter a number from 4-20 to specify the minimum number of characters for the web configurator login password.
At least one upper case	Enable this to require the web configurator login password to include at least one uppercase letter (A-Z).
At least one digit	Enable this to require the web configurator login password to include at least one number (0-9).
At least one special character	Enable this to require the web configurator login password to include at least one special character, including [!"#\$%^&*()_+={} ,;<>/:;.].
OK	Click OK to save your customized settings and exit this screen.
Cancel	Click Cancel to return the screen to its last-saved settings.

25.2 User Authentication Overview

This section describes how to set up AAA server and two-factor authentication.

- Use the **AAA Server** screen (see [Section 25.3 on page 403](#)) to configure the default authentication server (Local/LDAP/AD/RADIUS) to use for user authentication.
- Use the **Two-factor Authentication** screen (see [Section 25.4 on page 411](#)) to have double-layer security for local users to access a secured network behind the Zyxel Device.

25.2.1 What You Need To Know

AAA Servers Supported by the Zyxel Device

The following lists the types of authentication server the Zyxel Device supports.

- Local user database

The Zyxel Device uses the built-in local user database to authenticate administrative users logging into the Zyxel Device's Web Configurator or network access users logging into the network through the Zyxel Device. You can also use the local user database to authenticate VPN users.

- Directory Service (LDAP/AD)

LDAP (Lightweight Directory Access Protocol)/AD (Active Directory) is a directory service that is both a directory and a protocol for controlling access to a network. The directory consists of a database specialized for fast information retrieval and filtering activities. You create and store user profile and login information on the external server.

- RADIUS

RADIUS (Remote Authentication Dial-In User Service) authentication is a popular protocol used to authenticate users by means of an external or built-in RADIUS server. RADIUS authentication allows you to validate a large number of users from a central location.

Directory Structure

The directory entries are arranged in a hierarchical order much like a tree structure. Normally, the directory structure reflects the geographical or organizational boundaries. The following figure shows a basic directory structure branching from countries to organizations to organizational units to individuals.

Figure 247 Basic Directory Structure

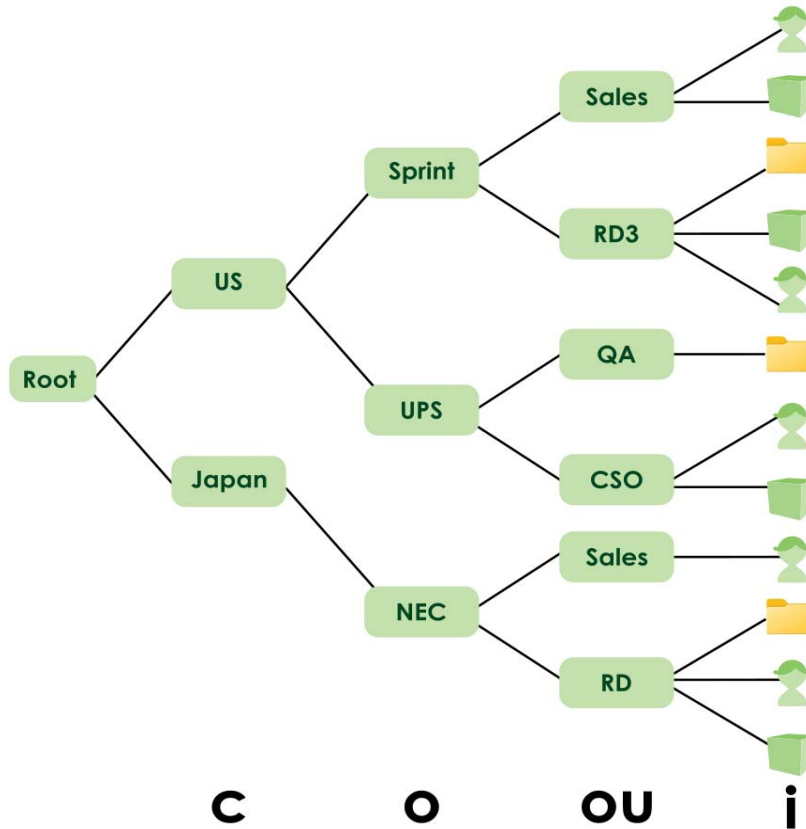

Distinguished Name (DN)

A DN uniquely identifies an entry in a directory. A DN consists of attribute-value pairs separated by commas. The leftmost attribute is the Relative Distinguished Name (RDN). This provides a unique name for entries that have the same "parent DN" ("cn=domain1.com, ou=Sales, o=MyCompany" in the following examples).

```
cn=domain1.com, ou = Sales, o=MyCompany, c=US
cn=domain1.com, ou = Sales, o=MyCompany, c=JP
```

Base DN

A base DN specifies a directory. A base DN usually contains information such as the name of an organization, a domain name and/or country. For example, o=MyCompany, c=UK where o means organization and c means country.

Bind DN

A bind DN is used to authenticate with an LDAP/AD server. For example a bind DN of `cn=zywallAdmin` allows the Zyxel Device to log into the LDAP/AD server using the user name of `zywallAdmin`. The bind DN is used in conjunction with a bind password. When a bind DN is not specified, the Zyxel Device will try to log in as an anonymous user. If the bind password is incorrect, the login will fail.

25.3 AAA Server Overview

You can use an AAA (Authentication, Authorization, Accounting) server to control access to your network. A Zyxel Device AAA server can be a Windows Active Directory (AD), a Lightweight Directory Access Protocol (LDAP) server or a RADIUS server. Use the **AAA Server** screens to create and manage objects that contain settings for using AAA servers. You can use AAA server objects in configuring IPsec VPN and SSL VPN rules.

Use RADIUS, AD and LDAP servers to authenticate users instead of (or in addition to) an internal Zyxel Device user database that is limited to the memory capacity of the Zyxel Device. In essence, AAA servers allow you to authenticate a large number of users from a central location.

Figure 248 AAA Server Network Example



25.3.1 AAA Server Configuration

Use the **AAA Server** screen to manage AD servers, LDAP servers and RADIUS servers the Zyxel Device can use in authenticating users.

Click **User & Authentication > AAA Server** to display the following screen.

Figure 249 User & Authentication > AAA Server

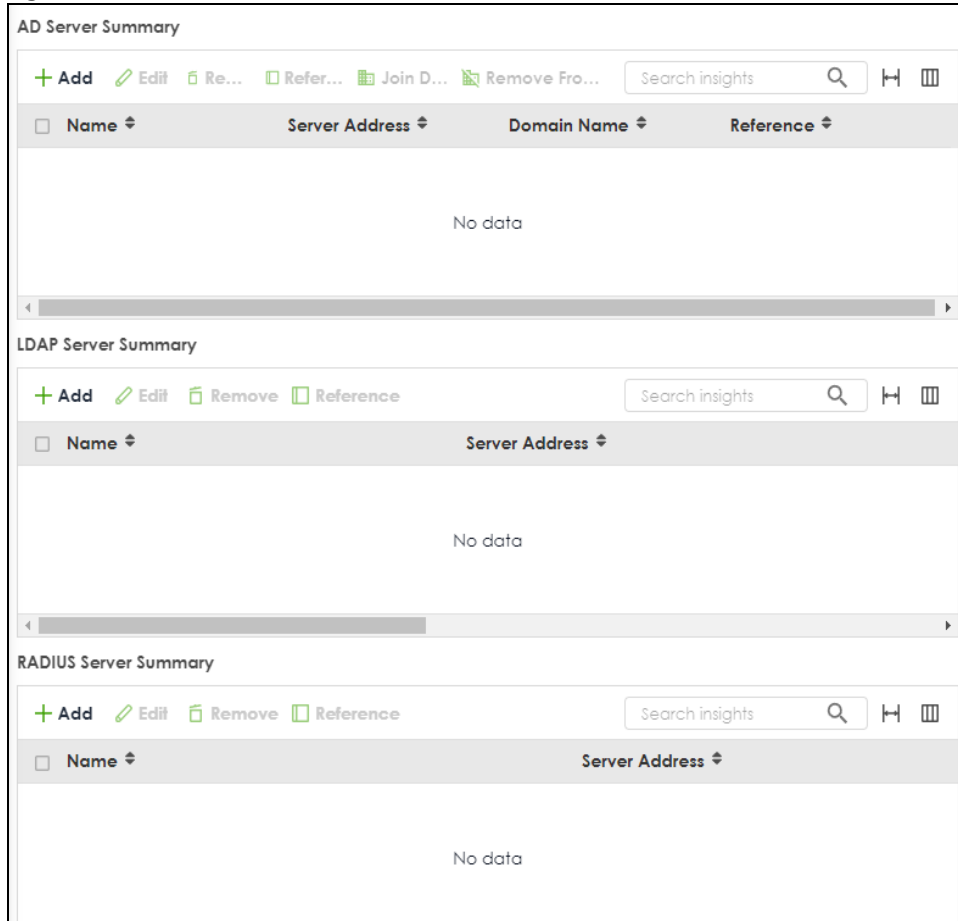

The following table describes the labels in this screen.

Table 199 User & Authentication > AAA Server

LABEL	DESCRIPTION
Add	Click this to create a new entry.
Edit	Double-click an entry or select it and click Edit to open a screen where you can modify the entry's settings.
Remove	To remove an entry, select it and click Remove . The Zyxel Device confirms you want to remove it before doing so.
References	Select an entry and click References to open a screen that shows which settings use the entry.
Join Domain	<p>Select an entry and click Join Domain to open a screen where you can add the AD server to the same domain as the Zyxel Device for central authentication management. See Section 25.3.3 on page 407 for more information.</p> <p>Note: The Zyxel Device can only be joined to one AD domain at a time. Adding a new AD domain will replace existing domain associations.</p> <p>Note: Ensure that the Domain Zone Forwarder configuration in the System > DNS & DDNS > DNS screen is correct before joining a domain.</p>

Table 199 User & Authentication > AAA Server (continued)

LABEL	DESCRIPTION
Remove From Domain	Select an entry and click Remove From Domain to remove the entry from the same domain as the Zyxel Device. The AD server is not isolated if it is not in the same domain as the Zyxel Device. You may do this for non-central authentication management such as when managing the Zyxel Device through NCC.
Name	This field displays the name of the AD, LDAP or RADIUS server.
Server Address	This is the address of the AD, LDAP or RADIUS server.
Domain Name	This is the domain name of the AD, LDAP or RADIUS server.
Reference	This is the number of times the entry is used in other settings.

25.3.2 Add an AD Server

Click **User & Authentication > AAA Server > AD Server Summary > Add** to display the following screen. Use this screen to create a new AD server entry or edit an existing one.

Figure 250 User & Authentication > AAA Server > AD Server Summary > Add

Configuration

Name
❗ The value in this field is invalid. It must begin with a letter and cannot exceed 31 characters. The valid characters are [0-9][a-z][A-Z][_.-].

Description (Optional)

Server Settings

Server Address (IP or FQDN)
❗ The value should be an IP address or a FQDN.

Backup Server Address (Optional) (IP or FQDN)

Port (1-65535)

Use SSL

Search time limit (1-300 seconds)

Case-sensitive User Names i

Server Authentication

Domain Name
❗ The value in this field is invalid. It cannot exceed 255 characters. The valid characters are [0-9][a-z][A-Z][_.-].

User Name
❗ The value in this field is invalid. It cannot exceed 63 characters. The valid characters are [0-9][a-z][A-Z][_()<>^+/:!*#&=.\$~%.-|].

Password
❗ The value in this field is invalid. The value must be 4 to 63 characters long. The valid characters are [0-9][a-z][A-Z][_()<>^+/:!*#&=.\$~%.-|].

Retype to Confirm

Advanced Settings ^

User Attributes

Search Base (Optional)

Login Name Attribute

Alternative Login Name Attribute (Optional)

Group Membership Attribute

Configuration Validation

Please enter an existing user account in this server to validate the above settings.

User Name

Some changes were made
What do you want to do then?

The following table describes the labels in this screen.

Table 200 User & Authentication > AAA Server > AD Server Summary > Add

LABEL	DESCRIPTION
Configuration	
Name	Enter a descriptive name for identification purposes. Use up to 31 single-byte characters, including 0-9a-zA-Z_-.
Description	Enter the description of each server, if any. The value cannot exceed 61 characters. Valid characters are [0-9][a-z][A-Z]['()+,./:=?;!*#@\$_%~"].
Server Settings	
Server Address	Enter the IPv4 address of the AD server.
Backup Server Address	If the AD server has a backup server, enter its address here.
Port	Specify the port number on the AD or LDAP server to which the Zyxel Device sends authentication requests. Enter a number between 1 and 65535. This port number should be the same on all AD server(s) in this group.
Use SSL	Select Use SSL to establish a secure connection to the AD server(s) from the Zyxel Device.
Search time limit	Specify the timeout period (between 1 and 300 seconds) before the Zyxel Device disconnects from the AD server. In this case, user authentication fails. Search timeout occurs when either the user information is not in the AD server(s) or the AD server(s) is down.
Case-sensitive User Names	Select this if the AD server checks the case of usernames.
Server Authentication	
Domain Name	Enter the domain name to which AD server belongs. The Zyxel Device uses this to access the AD server.
User Name	Enter the user name that the Zyxel Device uses to access the AD server.
Password	Enter the password that the Zyxel Device uses to access the AD server.
Retype to Confirm	Retype your new password for confirmation.
Advanced Settings	
User Attributes	
Search Base	An Active Directory server has a hierarchical structure for user account entries. The search base is where the search starts for user account entries. This can help to make the authentication procedure faster. To limit the search to begin in a container beneath the root of the domain, you must specify the fully-qualified name of the container in comma-delimited form. Start with the name of the base container and progress to the root of the domain. The search string is not case-sensitive; you can use either uppercase or lowercase letters. The entry cannot exceed 128 characters. Valid characters are [0-9][a-z][A-Z][_{}<>^`+/:!*#@&=\$.~%~,;].
Login Name Attribute	Enter the type of identifier the users are to use to log in. For example "name" or "email address"
Alternative Login Name Attribute	If there is a second type of identifier that the users can use to log in, enter it here. For example "name" or "email address".
Group Membership Attribute	An AD server defines attributes for its accounts. Enter the name of the attribute that the Zyxel Device is to check to determine to which group a user belongs. The value for this attribute is called a group identifier; it determines to which group a user belongs. You can add ext-group-user user objects to identify groups based on these group identifier values. For example you could have an attribute named "memberOf" with values like "sales", "RD", and "management". Then you could also create a ext-group-user user object for each group. One with "sales" as the group identifier, another for "RD" and a third for "management".
Configuration Validation	

Table 200 User & Authentication > AAA Server > AD Server Summary > Add (continued)

LABEL	DESCRIPTION
User Name	Enter an existing user account in this server to validate the above settings. Click the Test button
Apply	Click Apply to save the changes.
Cancel	Click Cancel to return the screen to its last-saved settings.

25.3.3 Join an AD Domain

Click **User & Authentication > AAA Server > Join AD Domain** to display the following screen. Use the **Join AD Domain** screen to add the AD server to the same domain as the Zyxel Device for central authentication management.

Figure 251 User & Authentication > AAA Server > AD server > Join AD Domain

The following table describes the labels in this screen.

Table 201 User & Authentication > AAA Server > AD server > Join AD Domain

LABEL	DESCRIPTION
Associated AD Server Object	This field shows the name of the AD server object.
AD Domain Name	This field shows the AD server domain name you want the Zyxel Device to join.
NetBIOS Domain Name	Type the NetBIOS name. This field is required by the AD server to join its AD domain. NetBIOS packets are TCP or UDP packets that enable a computer to connect to and communicate with a LAN which allows local computers to find computers on the remote network and vice versa. The name must begin with a letter and cannot exceed 15 characters. Valid characters are [0-9][a-z][A-Z][_-.].
User Name	Enter the user name for the Zyxel Device to access the AD server. The value must be 1 to 20 characters long. Valid characters are [0-9][a-z][A-Z][_(){}<>^+/:!*#@&=\$\?~% ;~"'].

Table 201 User & Authentication > AAA Server > AD server > Join AD Domain (continued)

LABEL	DESCRIPTION
Password	Enter the password associated with the user name. The value must be 4 to 63 characters long. Valid characters are [0-9][a-z][A-Z][_(){}<>^`+/:!*#@&=\$\?~%~ ;-"].
Retype to Confirm	Retype the password you entered in the Password field to confirm.
Apply	Click Apply to save the changes.
Cancel	Click Cancel to return the screen to its last-saved settings.

25.3.4 Add an LDAP Server

Click **User & Authentication > AAA Server > LDAP Server Summary > Add** to display the following screen. Use this screen to create a new LDAP server entry or edit an existing one.

Figure 252 User & Authentication > AAA Server > LDAP Server Summary > Add

Configuration

Name
❗ The value in this field is invalid. It must begin with a letter and cannot exceed 31 characters. The valid characters are [0-9][a-z][A-Z][_(){}<>^`+/:!*#@&=\$\?~%~|;-"].

Description (Optional)

Server Settings

Server Address (IP or FQDN)
❗ The value should be an IP address or a FQDN.

Backup Server Address (Optional) (IP or FQDN)

Port (1-65535)

Base DN
❗ The value in this field is invalid. It cannot exceed 128 characters. The valid characters are [0-9][a-z][A-Z][_(){}<>^`+/:!*#@&=\$\?~%~|;-].

Use SSL

Search time limit (1-300 seconds)

Case-sensitive User Names ❗

Server Authentication

Bind DN
❗ The value in this field is invalid. It cannot exceed 128 characters. The valid characters are [0-9][a-z][A-Z][_(){}<>^`+/:!*#@&=\$\?~%~|;-].

Password
❗ The value in this field is invalid. The value must be 4 to 63 characters long. The valid characters are [0-9][a-z][A-Z][_(){}<>^`+/:!*#@&=\$\?~%~|;-].

Retype to Confirm

Advanced Settings ^

User Attributes

Login Name Attribute

Alternative Login Name Attribute (Optional)

Group Membership Attribute

Some changes were made
 What do you want to do then?

The following table describes the labels in this screen.

Table 202 User & Authentication > AAA Server > LDAP Server Summary > Add

LABEL	DESCRIPTION
Configuration	
Name	Enter a descriptive name for identification purposes. Use up to 31 single-byte characters, including 0-9a-zA-Z_-.
Description	Enter the description of each server, if any. Use up to 61 single-byte characters, including 0-9a-zA-Z'()+,./:=?;!*#@\$_%~".
Server Settings	
Server Address	Enter the IPv4 address of the LDAP server.
Backup Server Address	If the LDAP server has a backup server, enter its address here.
Port	Specify the port number on the LDAP server to which the Zyxel Device sends authentication requests. Enter a number between 1 and 65535. This port number should be the same on all LDAP server(s) in this group.
Base DN	A base DN is the point from where a server will search for users. The entry cannot exceed 128 characters. Valid characters are [0-9][a-z][A-Z][_(){}<>^`+/:!*#@&=\$.~%~,;].
Use SSL	Select Use SSL to establish a secure connection to the LDAP server(s).
Search time limit	Specify the timeout period (between 1 and 300 seconds) before the Zyxel Device disconnects from the LDAP server. In this case, user authentication fails. Search timeout occurs when either the user information is not in the LDAP server(s) or the LDAP server(s) is down.
Case-sensitive User Names	Select this if you want configure your username as case-sensitive.
Server Authentication	
Bind DN	A bind DN is an object that you bind to inside LDAP to give you permission to make changes. The entry cannot exceed 128 characters. Valid characters are [0-9][a-z][A-Z][_(){}<>^`+/:!*#@&=\$.~%~,;].
Password	Enter the password that the Zyxel Device uses to access the LDAP server.
Retype to Confirm	Retype your new password for confirmation.
Advanced Settings	
User Attributes	
Login Name Attribute	Enter the type of identifier the users are to use to log in. For example "name" or "email address".
Alternative Login Name Attribute	If there is a second type of identifier that the users can use to log in, enter it here. For example "name" or "email address".
Group Membership Attribute	A LDAP server defines attributes for its accounts. Enter the name of the attribute that the Zyxel Device is to check to determine to which group a user belongs. The value for this attribute is called a group identifier; it determines to which group a user belongs. You can add ext-group-user user objects to identify groups based on these group identifier values. For example you could have an attribute named "memberOf" with values like "sales", "RD", and "management". Then you could also create a ext-group-user user object for each group. One with "sales" as the group identifier, another for "RD" and a third for "management".
Apply	Click Apply to save the changes.
Cancel	Click Cancel to return the screen to its last-saved settings.

25.3.5 Add a RADIUS Server

Click **User & Authentication > AAA Server > RADIUS Server Summary > Add** to display the following screen. Use this screen to create a new RADIUS server entry or edit an existing one.

Figure 253 User & Authentication > AAA Server > RADIUS Server Summary > Add

The following table describes the labels in this screen.

Table 203 User & Authentication > AAA Server > RADIUS Server Summary > Add

LABEL	DESCRIPTION
Name	Enter a descriptive name for identification purposes. Use up to 30 single-byte characters, including 0-9a-zA-Z_-.
Description	Enter the description of each server, if any. Use up to 61 single-byte characters, including 0-9a-zA-Z'()+,./:=?;!*#@\$_%-".
Server Address	Enter the IPv4 address or FQDN of the RADIUS server.
Authentication Port	Specify the port number on the RADIUS server to which the Zyxel Device sends authentication requests. Enter a number between 1 and 65535.
Backup Server Address	If the RADIUS server has a backup server, enter its address here.

Table 203 User & Authentication > AAA Server > RADIUS Server Summary > Add (continued)

LABEL	DESCRIPTION
Backup Authentication Port	Specify the port number on the RADIUS server to which the Zyxel Device sends authentication requests. Enter a number between 1 and 65535.
Key	Enter a password (up to 63 single-byte characters, including 0-9a-zA-Z_{}<>^`+/:!*#@&=\$\?~%, ;-) as the key to be shared between the external authentication server and the Zyxel Device. Your password will be encrypted when you configure this field. The key is not sent over the network. This key must be the same on the external authentication server and the Zyxel Device.
Change of Authorization	The external RADIUS server can change its authentication policy and send CoA (Change of Authorization) or RADIUS Disconnect messages in order to terminate the subscriber's service. Select this option to allow the Zyxel Device to disconnect wireless clients based on the information (such as client's user name and MAC address) specified in CoA or RADIUS Disconnect messages sent by the RADIUS server.
Server Address	Enter the IPv4 address or Fully-Qualified Domain Name (FQDN) of the RADIUS accounting server.
Accounting Port	Specify the port number on the RADIUS server to which the Zyxel Device sends accounting information. Enter a number between 1 and 65535.
Backup Server Address	If the RADIUS server has a backup accounting server, enter its address here.
Backup Accounting Port	Specify the port number on the RADIUS server to which the Zyxel Device sends accounting information. Enter a number between 1 and 65535.
Key	Enter a password (up to 15 alphanumeric characters) as the key to be shared between the external authentication server and the Zyxel Device. The key is not sent over the network. This key must be the same on the external authentication server and the Zyxel Device.
Timeout	Specify the timeout period (between 1 and 300 seconds) before the Zyxel Device disconnects from the RADIUS server. In this case, user authentication fails. Search timeout occurs when either the user information is not in the RADIUS server or the RADIUS server is down.
NAS IP Address	Type the IP address of the NAS (Network Access Server).
NAS Identifier	If the RADIUS server requires the Zyxel Device to provide the Network Access Server identifier attribute with a specific value, enter it here.
Case-sensitive User Names	Select this if you want configure your username as case-sensitive.
Group Membership Attribute	A RADIUS server defines attributes for its accounts. Select the name and number of the attribute that the Zyxel Device is to check to determine to which group a user belongs. If it does not display, select user-defined and specify the attribute's number. This attribute's value is called a group identifier; it determines to which group a user belongs.
Apply	Click Apply to save the changes.
Cancel	Click Cancel to return the screen to its last-saved settings.

25.4 Two-Factor Authentication Overview

Use two-factor authentication to have double-layer security for local users in the Zyxel Device database to access the Zyxel Device or a secured network behind the Zyxel Device via a VPN tunnel.

The first layer is the Zyxel Device's login user name / password and the second layer is using the Google Authenticator app.

Note: The user must download and set up the Google Authenticator app first.

This section introduces how two-factor authentication works.

Admin Access Via the Web Configurator or SSH

- 1 A local admin user connects to the Zyxel Device through the Web Configurator or SSH.
- 2 The Zyxel Device requests the admin user's user-name and password from the local Zyxel Device database in order to authenticate this admin user.
- 3 If all credentials are correct, then the Zyxel Device requests the Google Authenticator code.
- 4 The admin user must enter the authorization code within a specified deadline (**Valid Time**).
- 5 If the authorization is correct and received on time, then the admin user can log into Zyxel Device. If the authorization deadline has expired, then the admin user has to log in again. If authorization credentials are incorrect or the code was not received, then the admin user should contact the network administrator.

25.4.0.1 Two-factor Authentication Pre-configuration

Before configuration, you must:

- Set up the user's user-name and password in the local Zyxel Device database.
- Enable Two-factor Authentication in **User & Authentication > User/Group > User > Edit > Two-factor Authentication** for a specific user
- Enable Two-factor Authentication in **User & Authentication > User Authentication > Two-factor Authentication** for the Zyxel Device
- Enable **HTTP, HTTPS** and/or **SSH** in **System > Settings > Administration Settings**.
- Add **HTTP, HTTPS** and/or **SSH** in the **Object > Service > Service Group > Default_Allow_WAN_To_ZyWALL** service group. This service group defines the default services allowed in the **WAN_to_Device** security policy.

Two-Factor authentication will fail under the following conditions:

- The user's credentials are not in the in the local Zyxel Device database.
- You omit any of the pre-configuration items. Make sure to perform all pre-configuration items.
- Authorization times out. Extend the **Valid Time** in **User & Authentication > User Authentication > Two-factor Authentication > VPN Access**.
- You are unable to access Google Authenticator (you lost your phone or uninstalled the app). Log in using one of the backup codes.
- You get a Google Authenticator verification error. You must enter the code within the time displayed in Google Authenticator. The time on your cellphone and the time on the Zyxel Device must be the same.

Google Authenticator Settings

The following is a list of specifications and limitations on using Google Authenticator for two-factor authentication.

- Users authenticated by external servers, such as AD (Windows Active Directory), LDAP (Lightweight Directory Access Protocol), or RADIUS are not supported.
- A user must setup Google Authenticator on their mobile device before they can successfully authenticate with the Zyxel Device.
- Verification code length: 6 digits.
- Maximum verification code failed attempts: 3
- Backup code length: 8 digits

25.4.1 User Authentication Two-Factor Authentication

Use this screen to configure double-layer security for local users to access the Zyxel Device or a secured network behind the Zyxel Device via a VPN tunnel.

Go to **User & Authentication > User Authentication > Two-factor Authentication** and configure the following screen as shown.

Figure 254 User & Authentication > User Authentication > Two-factor Authentication

The screenshot shows the configuration page for Two-factor Authentication. The breadcrumb navigation is "User & Authentication > User Authentication > Two-factor Authentication". There are two tabs: "AAA Server" and "Two-factor Authentication", with the latter selected. The page is organized into three main sections:

- Admin Access:**
 - Enable:
 - Valid Time: (1-5 minutes)
 - Two-factor Authentication for Services:
 - Web
 - SSH
- VPN Access:**
 - Enable:
 - Valid Time: (1-5 minutes)
 - Two-factor Authentication for Services:
 - SSL VPN Access
 - IPsec VPN Access
- Delivery Settings:**
 - Authorize Link URL Address:
 - From Interface:
 - Authorized Port: (1-65535) ⓘ

A green notification box at the bottom right contains the text: "Some changes were made. What do you want to do then?" with "Cancel" and "Apply" buttons.

The following table describes the labels in this screen.

Table 204 User & Authentication > User Authentication > Two-factor Authentication

LABEL	DESCRIPTION
Enable	Enable this to require double-layer security to access the Zyxel Device via the Web Configurator or SSH.
Valid Time	Enter the maximum time (in minutes) within which the user must enter the key received in Google Authenticator.
Two-factor Authentication for Services	Select which services require Two-Factor Authentication for the admin user. You must select at least one. <ul style="list-style-type: none"> • Web • SSH
VPN Access	
Enable	Enable this to require double-layer security to access a secured network behind the Zyxel Device via a VPN tunnel.
Valid time	Enter the maximum time (in minutes) within which the user must enter the key received in Google Authenticator in order to get authorization for access to a secured network behind the Zyxel Device via a VPN tunnel.
Two-factor Authentication for Services	Select which types of VPN tunnels require Two-Factor Authentication for the admin user. You must select at least one. You should have configured the VPN tunnel first. <ul style="list-style-type: none"> • SSL VPN Access • IPSec VPN Access
Delivery Settings	Use this section to configure how to send the VPN link.
Authorize Link URL Address	Configure the link that the user will receive. The user must be able to access the link. <ul style="list-style-type: none"> • http/https: you must enable HTTP or HTTPS in System > Settings • From Interface/User-Defined: select the Zyxel Device WAN interface (ge3/4) or select User-Defined and then enter an IP address or domain name.
Authorized Port	Configure a port between 1 and 65535 that is not in use by other services. Use this port for two-factor authentication of VPN clients to access the network behind the Zyxel Device. VPN clients do not need to change the port number on their devices, because the link to access the network behind the Zyxel Devices will contain the new port number. You must configure a security policy to allow access to this port from the WAN.
Apply	Click Apply to save the changes.
Cancel	Click Cancel to return the screen to its last-saved settings.

CHAPTER 26

System

26.1 Overview

Use the system screens to configure general Zyxel Device settings.

26.1.1 What You Can Do in this Chapter

- Use the **System > Settings** screen (see [Section 26.2 on page 415](#)) to configure the Zyxel Device basic system settings.
- Use the **System > Device HA** screens (see [Section 26.3 on page 421](#)) to configure a backup for the Zyxel Device.
- Use the **System > DNS & DDNS** screen (see [Section 26.4 on page 429](#)) to configure the Zyxel Device DNS and DDNS settings.
- Use the **System > SNMP** screen (see [Section 26.5 on page 443](#)) to configure the Zyxel Device SNMP settings.
- Use the **System > Notification** screen (see [Section 26.6 on page 447](#)) to configure a mail server to receive reports and notification emails.
- For an overview of certificates, see [Section 26.7 on page 453](#).
- Use the **System > My Certificates** screen (see [Section 26.8 on page 455](#)) to generate self-signed certificates or certification requests.
- Use the **System > Trusted Certificates** screens (see [Section 26.9 on page 464](#)) to save CA certificates and trusted remote host certificates to the Zyxel Device. The Zyxel Device trusts any valid certificate that you have imported as a trusted certificate. It also trusts any valid certificate signed by any of the certificates that you have imported as a trusted certificate.
- Use the **System > Advanced** screen (see [Section 26.10 on page 468](#)) to view UDP and ICMP timeout settings on your Zyxel Device and to enable or disable ARP spoofing prevention, device insight, and LLDP functions.

See each section for related background information and term definitions.

26.2 Settings

Use the **Settings** screen to configure the hostname, system time, the Zyxel Device connection settings and language settings.

26.2.1 System Settings

Use this section to configure the Zyxel Device host name. A host name is the unique name by which a device is known on a network.

26.2.2 System Time

Use this section to configure the Zyxel Device time settings. For effective scheduling and logging, the Zyxel Device system time must be accurate. The Zyxel Device's Real Time Chip (RTC) keeps track of the time and date. There is also a software mechanism to set the time manually or get the current time and date from an external server.

To change your Zyxel Device's time based on your local time zone and date, go to **System > Settings > System Time**. You can manually set the Zyxel Device's time and date or have the Zyxel Device get the date and time from a time server.

To manually set the Zyxel Device date and time.

- 1 Go to **System > Settings > System Time**.
- 2 Select **Manual** in the **Time** field. Then enter or select the Zyxel Device's time and date.
- 3 In the **Timezone** field, select your timezone from the list.
- 4 Click **Apply**.

To get the Zyxel Device date and time from a time server

- 1 Go to **System > Settings > System Time**.
- 2 Select **Auto Sync** in the **Time** and **Timezone** field.
- 3 Click **Apply**.

26.2.3 Administration Settings

Use this section to configure secure and insecure connection of the Zyxel Device coming in from the WAN. HTTPS and SSH access are secure. HTTP access is not secure.

Note: To allow the Zyxel Device to be accessed from a specified computer using a service, make sure you do not have a service control rule or to-Zyxel Device security policy rule to block that traffic.

To stop a service from accessing the Zyxel Device, slide the switch to the left in the corresponding service screen to disable the service.

System Timeout

There is a lease timeout for administrators. The Zyxel Device automatically logs you out if the management session remains idle for longer than this timeout period. The management session does not time out when a statistics screen is polling.

Each user is also forced to log in the Zyxel Device for authentication again when the reauthentication time expires.

You can change the timeout settings in the **User/Group** screens.

HTTPS

You can set the Zyxel Device to use HTTP or HTTPS (HTTPS adds security) for Web Configurator sessions.

HTTPS (HyperText Transfer Protocol over Secure Socket Layer, or HTTP over SSL) is a web protocol that encrypts and decrypts web pages. Secure Socket Layer (SSL) is an application-level protocol that enables secure transactions of data by ensuring confidentiality (an unauthorized party cannot read the transferred data), authentication (one party can identify the other party) and data integrity (you know if data has been changed).

It relies upon certificates, public keys, and private keys.

HTTPS on the Zyxel Device is used so that you can securely access the Zyxel Device using the Web Configurator. The SSL protocol specifies that the HTTPS server (the Zyxel Device) must always authenticate itself to the HTTPS client (the computer which requests the HTTPS connection with the Zyxel Device), whereas the HTTPS client only should authenticate itself when the HTTPS server requires it to do so (enable **Authenticate Client Certificates** in the **Administration Settings** screen). **Authenticate Client Certificates** is optional and if selected means the HTTPS client must send the Zyxel Device a certificate. You must apply for a certificate for the browser from a CA that is a trusted CA on the Zyxel Device.

Please refer to the following figure.

- 1 HTTPS connection requests from an SSL-aware web browser go to port 443 (by default) on the Zyxel Device's web server.
- 2 HTTP connection requests from a web browser go to port 80 (by default) on the Zyxel Device's web server.

Figure 255 HTTP/HTTPS Implementation

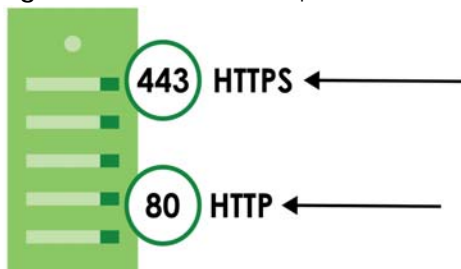

Note: If you disable **HTTP** in the **Administration Settings** screen, then the Zyxel Device blocks all HTTP connection attempts.

SSH

You can use SSH (Secure Shell) to securely access the Zyxel Device's command line interface.

SSH is a secure communication protocol that combines authentication and data encryption to provide secure encrypted communication between two hosts over an unsecured network. In the following figure, computer **A** on the Internet uses SSH to securely connect to the WAN port of the Zyxel Device for a management session.

Note: To allow an SSH connection to the Zyxel Device, add **SSH** in the **Object > Service > Service Group > Default_Allow_WAN_To_ZyWALL** service group which defines the default services allowed in the **WAN_to_Device** security policy.

Figure 256 SSH Communication Over the WAN Example

Your Zyxel Device supports SSH version 2 using RSA authentication and four encryption methods (AES, 3DES, Archfour, and Blowfish). The SSH server is implemented on the Zyxel Device for management using port 22 (by default).

You must install an SSH client program on a client computer (Windows or Linux operating system) that is used to connect to the Zyxel Device over SSH.

FTP

You can upload and download the Zyxel Device's firmware and configuration files using FTP. To use this feature, your computer must have an FTP client.

Device Insight

Use **Device Insight** to collect status and basic information of the clients connected to the Zyxel Device internal interfaces or IPsec VPN; see [Section 5.13 on page 94](#) for more information.

26.2.4 Settings

Use this section to select a display language for the Zyxel Device's Web Configurator screens.

Click **System > Settings** to open the following screen.

Figure 257 System > Settings

System Settings

Host Name

System Time

Current Time 2022/12/26 17:36:34

Time Auto Sync
 Manual

Timezone Auto Sync Manual

Administration Settings

HTTP	Enable	<input checked="" type="checkbox"/>
	HTTP Port	<input type="text" value="80"/>
	Redirect To HTTPS	<input checked="" type="checkbox"/>
HTTPS	Enable	<input checked="" type="checkbox"/>
	HTTPS Port	<input type="text" value="443"/>
	Authenticate Client Certificates	<input type="checkbox"/>
	Server Certificate	<input type="text" value="default"/>
SSH	Enable	<input checked="" type="checkbox"/>
	SSH Port	<input type="text" value="22"/>
	Server Certificate	<input type="text" value="default"/>
FTP Server	Enable	<input checked="" type="checkbox"/>
	TLS required	<input type="checkbox"/>
	FTP Port	<input type="text" value="21"/>
	Server Certificate	<input type="text" value="default"/>

Display

Language

User LED

Event

Device Insight

Enable

Some changes were made
What do you want to do then?

The following table describes the labels in this screen.

Table 205 System > System Settings

LABEL	DESCRIPTION
System Settings	
Host Name	Enter a descriptive name to identify your Zyxel Device device. This name can be up to 30 alphanumeric characters long. Spaces are not allowed, but dashes (-) underscores (_) and periods (.) are accepted.
System Time	
Current Time	This field displays the present date and time of your Zyxel Device.
Time	<p>Select Auto Sync to have the Zyxel Device get the time and date from the time server. The Zyxel Device requests time and date settings from the time server under the following circumstances.</p> <ul style="list-style-type: none"> When the Zyxel Device starts up. When you click Apply after selecting Auto Sync in this screen. 24-hour intervals after starting up. <p>Select Manual to enter or select the time and date manually. When you enter the time and date settings manually, the Zyxel Device uses the new settings once you click Apply.</p>
Timezone	<p>Select Auto Sync for the Zyxel Device to automatically get its timezone.</p> <p>Select Manual to choose the timezone of your location. This will set the time difference between your timezone and Greenwich Mean Time (GMT).</p>
Administration Settings	
HTTP Enable	Enable to allow access to the Zyxel Device using HTTP connections.
HTTP Port	<p>The HTTP server listens on port 80 by default. If you change the HTTP port to a different number on the Zyxel Device, for example 8080, then you must notify people who need to access the Zyxel Device Web Configurator to use "http://Zyxel Device IP Address:8080" as the URL.</p> <p>If you choose a port already in use, you will see a port conflict message telling you to choose another port.</p> <p>System > Settings > HTTP port conflict with another service System > Settings > HTTPS. Choose a different port for configuration changes.</p>
Redirect to HTTPS	Enable this to redirect all HTTP connection requests to the HTTPS server to allow only secure Web Configurator access.
HTTPS Enable	Enable to allow access to the Zyxel Device Web Configurator using secure HTTPS connections.
HTTPS Port	<p>The HTTPS server listens on port 443 by default. If you change the HTTPS port to a different number on the Zyxel Device, for example 8443, then you must notify people who need to access the Zyxel Device Web Configurator to use "https://Zyxel Device IP Address:8443" as the URL.</p> <p>If you choose a port already in use, you will see a port conflict message telling you to choose another port.</p> <p>System > Settings > HTTPS port conflict with another service System > Settings > HTTP. Choose a different port for configuration changes.</p>
Authenticate Client Certificates	Enable this to require the SSL client to authenticate itself to the Zyxel Device by sending the Zyxel Device a certificate. To do that the SSL client must have a CA-signed certificate from a CA that has been imported as a trusted CA on the Zyxel Device.
Server Certificate	Select a certificate the HTTPS server (the Zyxel Device) uses to authenticate itself to the HTTPS client. You must have certificates already configured in the My Certificates screen.
SSH Enable	Enable to allow access to the Zyxel Device using SSH connections.
SSH Port	<p>The SSH port is 22 by default. You may change the server port number for a service if needed, however you must use the same port number in order to use that service for remote management.</p> <p>If you choose a port already in use, you will see a port conflict message telling you to choose another port.</p> <p>System > Settings > SSH port conflict with another service System > Settings > FTP. Choose a different port for configuration changes.</p>

Table 205 System > System Settings (continued)

LABEL	DESCRIPTION
Server Certificate	Select a certificate whose corresponding private key is to be used to identify the Zyxel Device for SSH connections. You must have certificates already configured in the My Certificates screen.
FTP Enable	Enable to allow access to the Zyxel Device using FTP connections.
TLS required	Enable to use FTP over TLS (Transport Layer Security) to encrypt communication. This implements TLS as a security mechanism to secure FTP clients and servers.
FTP Port	The FTP port is 21 by default. You may change the server port number for a service if needed, however you must use the same port number in order to use that service for remote management. If you choose a port already in use, you will see a port conflict message telling you to choose another port. System > Settings > FTP port conflict with another service System > Settings > SSH. Choose a different port for configuration changes.
Server Certificate	Select a certificate whose corresponding private key is to be used to identify the Zyxel Device for FTP connections. You must have certificates already configured in the My Certificates screen.
Display	
Language	Select a display language for the Zyxel Device's web configurator screens. The web configurator screens will display in the new language after you click Apply .
User LED	The USER LED is located at the front panel of the Zyxel Device. Use this LED to check one of the following: <ul style="list-style-type: none"> Admin account login status. User IP address locked out status. License status. New firmware available for update.
Event	Select how you want the USER LED to behave. <ul style="list-style-type: none"> Select Admin login (green on) if you want the USER LED to be steady green when there are admin accounts logged into the Zyxel Device. Select User Lockout (amber on) if you want the USER LED to be steady amber when a user IP address is locked out of the Zyxel Device. A user IP address will be locked out when the user has logged into the Zyxel Device unsuccessfully (for example, wrong password) for more than three times. Select License Expired (amber on) if you want the USER LED to be steady amber when a Zyxel Device service license has expired. Select New Firmware Available (green blinking) if you want the USER LED to blink green when there is new firmware available for upload. Select Off to turn off the USER LED.
Device Insight	Enable Device Insight to collect status and basic information of the clients connected to the Zyxel Device internal interfaces or IPSec VPN.
Apply	Click Apply to save your changes to the Zyxel Device.
Reset	Click Reset to return the screen to its last-saved settings.

26.3 Device HA (High Availability)

Device HA lets a passive (secondary) Zyxel Device automatically take over if the active (primary) Zyxel Device fails. Both Zyxel Devices must be the same model with the same firmware version. Device HA pairing occurs when Device HA is set up successfully on both Zyxel Devices.

The primary Zyxel Device is the license controller. Existing licenses on the secondary Zyxel Device are appended to the licenses on the primary Zyxel Device after pairing occurs. When updating licenses, update them on the primary Zyxel Device.

The following features can be transferred to the secondary Zyxel Device when it becomes active using Device HA:

- Start-up and Running Configuration
- Signatures
- Device Insight
- External Block List
- DHCP Leasing Entries
- Two-factor Authentication
- Certificates
- Licenses Including NCC if applicable
- Zyxel Device Time

26.3.1 What You Can Do in These Screens

- Use the **HA Status** screen ([Section 26.3.7 on page 424](#)) to see the license status for Device HA, and see the status of the active and passive devices.
- Use the **HA Configuration** screen ([Section 26.3.8 on page 426](#)) to configure Device HA global settings, monitored interfaces and synchronization settings.
- Use the **HA Log** screen ([Section 26.3.9 on page 427](#)) to see logs of the active and passive devices.

26.3.2 Heartbeat

Device HA uses a dedicated heartbeat link between an active and a passive device for status syncing and to trigger failover and backup to the passive device if the active device becomes unresponsive. On the passive device, all ports are disabled except for the port with the heartbeat link.

In the following example, Zyxel Device **A** is the active device that is connected to passive device Zyxel Device **B** through a dedicated link that is used for heartbeat control, configuration synchronization and troubleshooting. All links on Zyxel Device **B** are down except for the dedicated heartbeat link.

Figure 258 Device HA Overview



Note: Make sure that the heartbeat port is not already in an interface that is already configured for other features such as VLAN, Bridge.

Note: The dedicated heartbeat link port must be the highest-numbered copper Ethernet port on each Zyxel Device for Device HA to work. At the time of writing, these are the models that support HA with associated heartbeat link ports.

Table 206 Device HA Heartbeat Ports

MODEL	HEARTBEAT PORT
USG FLEX 200H / 200 HP	8
USG FLEX 500H / 700 H	12

Failover from the active Zyxel Device to the passive Zyxel Device occurs when:

- A monitored interface is down on the active Zyxel Device.
- The connectivity check on the heartbeat link exceeds the failure tolerance.

After failover, the initially active Zyxel Device becomes the passive Zyxel Device.

26.3.3 Firmware Upgrade on Paired Zyxel Devices

- 1 First, upgrade the firmware to the passive device.
- 2 After upgrade, the passive device becomes the active device and handles all traffic during the firmware upgrade.
- 3 Firmware is then upgraded to the passive primary device.
- 4 After the firmware upgrade is complete on both Zyxel Devices, the primary device becomes the active device again.

26.3.4 Preparing to Deploy Device HA

- 1 Make sure the passive Zyxel Device is offline, then enable Device HA in **System > Device HA > HA Configuration** in the active Zyxel Device.
- 2 The management IP addresses for both the active and passive Zyxel Devices must be in the same subnet.
- 3 Make sure the SSH service in **System > SSH** is enabled on both Zyxel Devices. SFTP (Secure File Transfer Protocol) is used to transfer files from the active to the passive Zyxel Device.
- 4 Connect the passive Zyxel Device to the active Zyxel Device using the heartbeat ports. These are the highest-numbered copper Ethernet ports on the Zyxel Devices - see [Table 206 on page 423](#).
- 5 If both Zyxel Devices are turned on at the same time with Device HA enabled, then they may send the heartbeat at the same time. In this case, the Zyxel Device with the **Primary (License Controller)** role becomes the active Zyxel Device.

26.3.5 Using NCC To Manage Device HA

You must register both Zyxel Devices on NCC, that is they must both belong to an organization. The passive Zyxel Device will be registered automatically in NCC if it is not already registered in NCC.

Both Zyxel Devices must be in the same organization and be registered to the same account.

The passive Zyxel Device is removed from the NCC site after Device HA pairing is complete, as a site in NCC can only have one Zyxel Device firewall (at the time of writing).

NCC automatically sends an email to notify users when Zyxel Devices are paired with licenses transferred.

26.3.6 Deployment Overview

Register both Zyxel Devices on NCC if you are using NCC.

- 1 Set up Device HA on the active Zyxel Device in **System > Device HA > HA Configuration**. Check the HA status in **System > Device HA > HA Status**, and view the log of the active Zyxel Device in **System > Device HA > HA Log**.
- 2 Configure Device HA on the passive Zyxel Device in **System > Device HA > HA Configuration**.
- 3 Connect the heartbeat Ethernet cable between the active and passive Zyxel Devices.
- 4 Verify the HA status of the active and passive Zyxel Devices in **System > Device HA > HA Status**.
- 5 Check the logs on the active Zyxel Device in **System > Device HA > HA Log**.

When you log into a Zyxel Device after Device HA pairing, you will see a banner to show if you are logged into the active or passive Zyxel Device.

26.3.7 HA Status

After you have configured Device HA in **System > Device HA > HA Configuration** go to this screen to view Device HA synchronization and failover status.

Go to **System > Device HA > HA Status** to view the following screen.

Figure 259 System > Device HA > HA Status

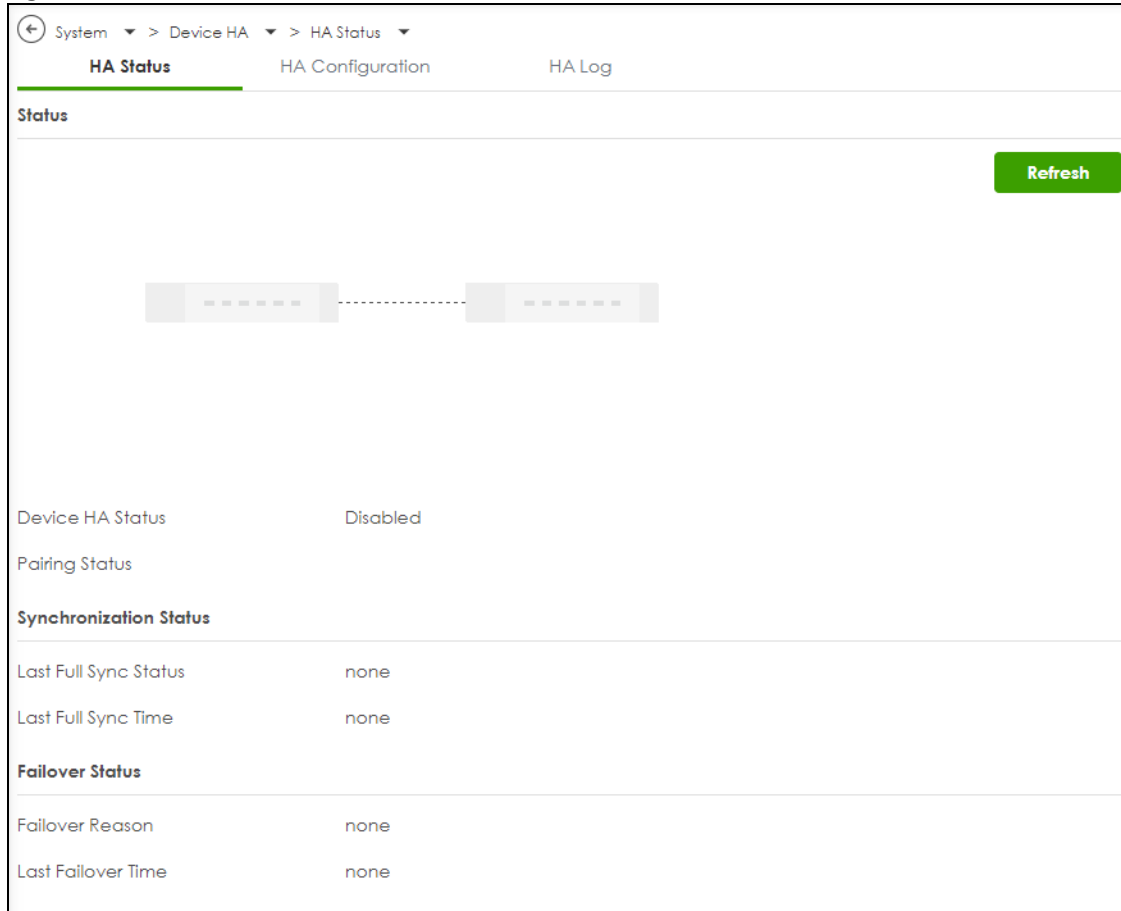

The following table describes the labels in this screen.

Table 207 System > Device HA > HA Status

LABEL	DESCRIPTION
Status	<p>Zyxel Devices are displayed according to role with the active Zyxel Device on the left and the passive Zyxel Device on the right. The active Zyxel Device is the initial active Zyxel Device, and the passive Zyxel Device is the initial passive Zyxel Device. The active becomes passive if failover occurs.</p> <p>The heartbeat link shows one of the following icons:</p> <ul style="list-style-type: none"> Running, indicating that the link is connected and the peer Zyxel Device is replying Disconnect, indicating that the link is not connected No response, indicating that the link is connected, but the peer Zyxel Device is not replying
Device HA Status	This displays if Device HA is Enabled or Disabled .
Pairing Status	<p>Device HA pairing occurs when Device HA is set up successfully on both Zyxel Devices. This field displays one of the following:</p> <ul style="list-style-type: none"> Pairing, indicating that Device HA is in progress Paired, indicating that Device HA has completed successfully Error, showing the reason that Device HA failed.

Table 207 System > Device HA > HA Status (continued)

LABEL	DESCRIPTION
Synchronization Status	This section displays information on feature transfer status and time after full synchronization occurs.
Last Full Sync Status	This displays In Progress , Success , Fail or none (if Device HA is not enabled or just after the Zyxel Device reboots).
Last Failover Time	This displays the date and time feature transfer occurred or none (if Device HA is not enabled or just after the Zyxel Device reboots).
Failover Status	This section displays the reason for failover and the time it occurred.
Failover Reason	This displays the reason for failover, such as Heartbeats missed , Monitor interface link down , Monitor interface connectivity check fail , Firmware upgrade , Heartbeats conflict . Heartbeats conflict may occur if both Zyxel Devices send heartbeats at the same time, for example, if both Zyxel Devices start up at the same time.
Last Failover Time	This displays the date and time the failover occurred.

26.3.8 HA Configuration

Configure Device HA on the Zyxel Device in **System > Device HA > HA Configuration**.

Figure 260 System > Device HA > HA Configuration

System > Device HA > HA Configuration

HA Status **HA Configuration** HA Log

General Settings

Enable

Management Configuration

Initial Role Primary (License Controller) Secondary

Active Node Management IP

Passive Node Management IP

Management IP Subnet Mask

Monitor Interface

Member

Failover on Monitored Interface Link Down

Failover on Monitored Connectivity Check Failure

Note

- If you want to configure connectivity check, please go to **Network > Interface**.
- Before configure HA, make sure the last copper Ethernet port is not already configured for other interface such as Ethernet, VLAN.
- Please always renew the license to the Primary device.

The following table describes the labels in this screen.

Table 208 System > Device HA > HA Configuration

LABEL	DESCRIPTION
General Settings	
Enable Device HA	<p>You must enable Device HA on both the active and passive Zyxel Devices. Before enabling Device HA, go to Network > Interface to configure the heartbeat link connectivity check between the initial active and initial passive Zyxel Devices. Make sure the passive Zyxel Device is offline when you enable Device HA on the active Zyxel Device.</p> <p>You cannot use Recovery Manager when you enable Device HA.</p>
Management Configuration	<p>Management IPs allows you to manage whichever is the active Zyxel Device when Device HA is paired. You must configure management IP addresses for both the active and passive Zyxel Devices and they must have the same subnet mask.</p>
Initial Role	<p>Select if this Zyxel Device is the initial active (Primary (License Controller)) or initial passive (Secondary) Zyxel Device.</p> <p>When you apply Device HA on the Secondary Zyxel Device, the LAN/WAN links will go down and you will be logged out of the web configurator. The following fields will also be grayed out.</p> <p>You must configure the following fields when you select Primary (License Controller).</p>
Active Node Management IP	Type the IPv4 address of the highest-numbered copper Ethernet port on the active Zyxel Device (the heartbeat dedicated link port).
Passive Node Management IP	Type the IPv4 address of the highest-numbered copper Ethernet port on the passive Zyxel Device (the heartbeat dedicated link port).
Management IP Subnet Mask	Primary and Secondary Zyxel Devices must use the same subnet mask. Enter a subnet mask such as 255.255.255.0, of the management IP addresses.
Monitor Interface	
Member	Member interface types can be Ethernet, VLAN, or Bridge. Select an interface to be monitored by Device HA to determine if a passive Zyxel Device should become active.
Failover on Monitored Interface Link Down	Enable this to have the passive Zyxel Device become the active Zyxel Device when a selected monitored interface fails.
Failover on Monitored Connectivity Check Failure	Enable this to have the passive Zyxel Device become the active Zyxel Device when the connectivity check fails on a selected monitored interface.
Cancel	Click Cancel to return the screen to its last-saved settings.
Apply	Click Apply to save your Device HA configurations back to the Zyxel Device but keep the Zyxel Device using Device HA (general).

26.3.9 HA Log

Use this screen to see Device HA logs on the local and peer Zyxel Devices. The local Zyxel Device is the Zyxel Device that you are currently logged into.

Go to **System > Device HA > HA Log** to display the following screen.

Figure 261 System > Device HA > HA Log

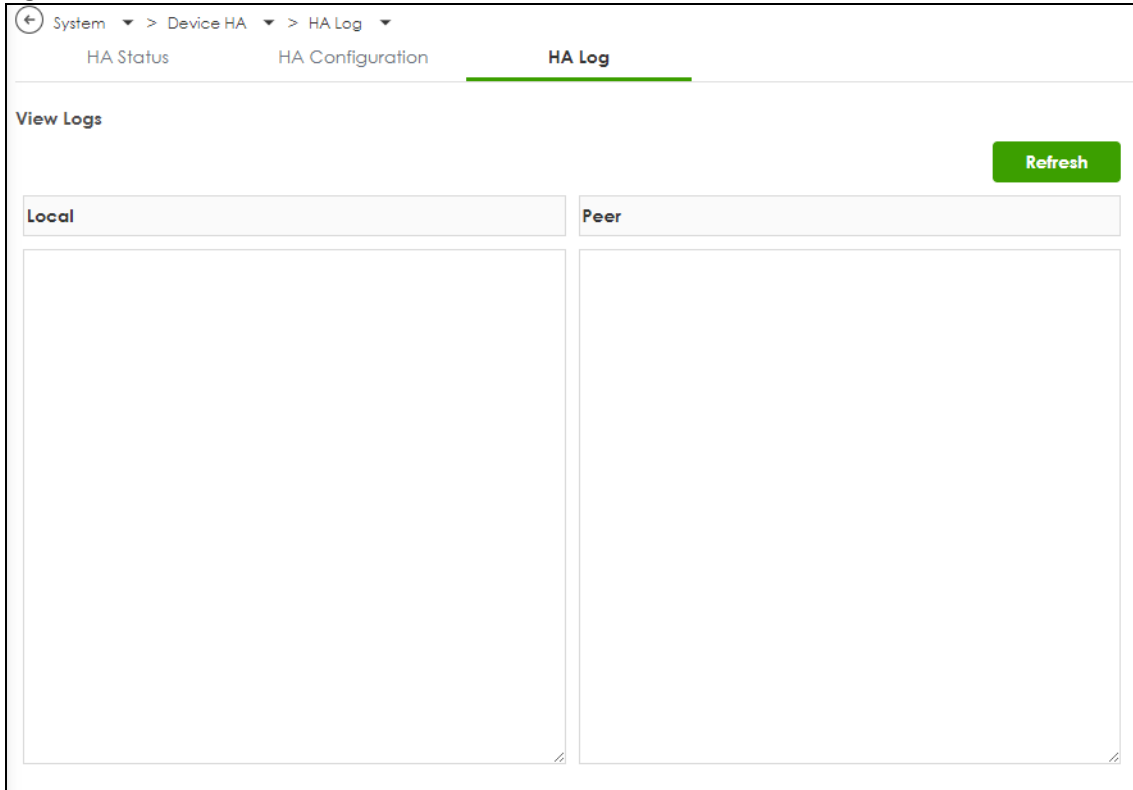

The following table describes the labels in this screen.

Table 209 System > Device HA > HA Log

LABEL	DESCRIPTION
View Logs	
Local	This displays Device HA logs on the Zyxel Device that you are currently logged into.
Peer	This displays Device HA logs on the Zyxel Device that has a heartbeat link to the Zyxel Device that you are currently logged into, that is, the Device HA peer.
Refresh	Click Refresh to update information in this screen.

The following is an example HA log screen when logging into the active Zyxel Device.

Figure 262 System > Device HA > HA Log Example

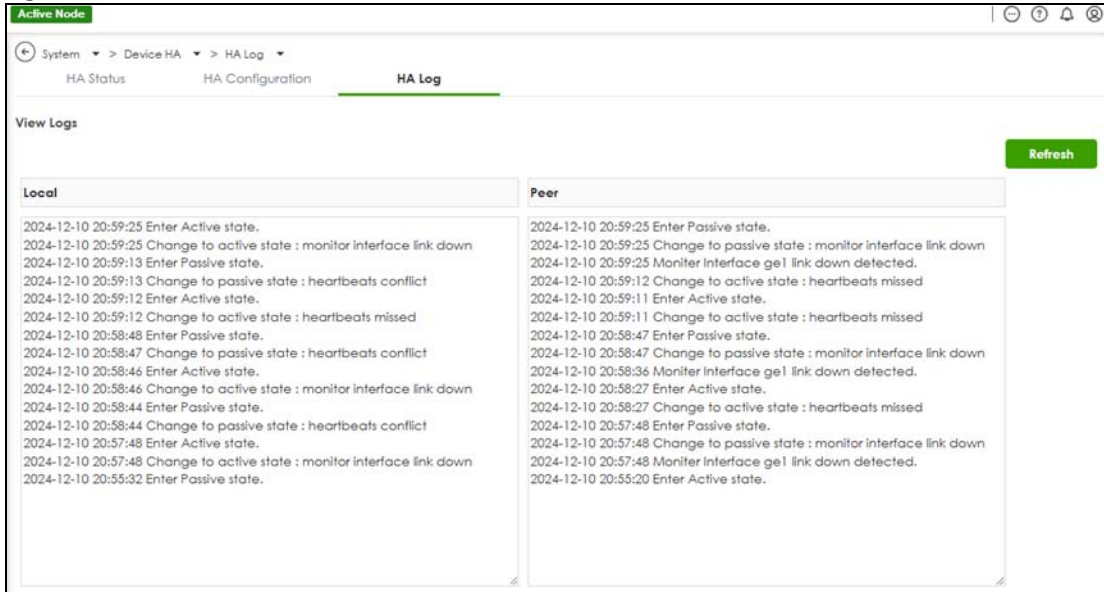

26.3.10 Disabling Device HA

Turning off an active or passive Zyxel Device alone does not disable Device HA. To disable Device HA, you must use **System > Device HA > HA Configuration** in the web configurator or CLI commands.

Note: Before disabling Device HA, you should turn off the passive Zyxel Device or disconnect all network cables from it.

26.4 DNS & DDNS

DNS (Domain Name System) is for mapping a domain name to its corresponding IP address and vice versa. The DNS server is extremely important because without it, you must know the IP address of a machine before you can access it.

Similarly, Dynamic DNS (DDNS) maps a domain name to a dynamic IP address. As a result, anyone can use the domain name to contact you (in NetMeeting, CU-SeeMe, etc.) or to access your FTP server or Web site, regardless of the current (dynamic) IP address.

Note: You must have a public WAN IP address to use Dynamic DNS.

You must set up a dynamic DNS account with a supported DNS service provider before you can use Dynamic DNS services with the Zyxel Device. When registration is complete, the DNS service provider gives you a password or key. At the time of writing, the Zyxel Device supports the following DNS service providers. See the listed websites for details about the DNS services offered by each.

Table 210 DDNS Service Providers

PROVIDER	SERVICE TYPES SUPPORTED	WEBSITE
DynDNS	Dynamic DNS, Static DNS, and Custom DNS	www.dyndns.com
Dynu	Basic, Premium	www.dynu.com

Table 210 DDNS Service Providers (continued)

PROVIDER	SERVICE TYPES SUPPORTED	WEBSITE
No-IP	No-IP	www.no-ip.com
Peanut Hull	Peanut Hull	www.oray.cn
3322	3322 Dynamic DNS, 3322 Static DNS	www.3322.org
Selfhost	Selfhost	selfhost.de

Note: Record your DDNS account's user name, password, and domain name to use to configure the Zyxel Device.

After you configure the Zyxel Device, it automatically sends updated IP addresses to the DDNS service provider, which helps redirect traffic accordingly.

26.4.1 DNS Server Address Assignment

The Zyxel Device can get the DNS server addresses in the following ways.

- The ISP tells you the DNS server addresses, usually in the form of an information sheet, when you sign up. If your ISP gives you DNS server addresses, manually enter them in the DNS server fields.
- If your ISP dynamically assigns the DNS server IP addresses (along with the Zyxel Device's WAN IP address), set the DNS server fields to get the DNS server address from the ISP.
- You can manually enter the IP addresses of other DNS servers.

26.4.2 The DNS Screen

Click **System > DNS & DDNS > DNS** to change your Zyxel Device's DNS settings. Use the **DNS** screen to configure the Zyxel Device to use a DNS server to resolve domain names for Zyxel Device system features like VPN, DDNS and the time server. You can also configure the Zyxel Device to accept or discard DNS queries. Use the **Network > Interface** screens to configure the DNS server information that the Zyxel Device sends to the specified DHCP client devices.

A name query begins at a client computer and is passed to a resolver, a DNS client service, for resolution. The Zyxel Device can be a DNS client service. The Zyxel Device can resolve a DNS query locally using cached Resource Records (RR) obtained from a previous query (and kept for a period of time). If the Zyxel Device does not have the requested information, it can forward the request to DNS servers. This is known as recursion.

The Zyxel Device can ask a DNS server to use recursion to resolve its DNS client requests. If recursion on the Zyxel Device or a DNS server is disabled, they cannot forward DNS requests for resolution.

A Domain Name Server (DNS) amplification attack is a kind of Distributed Denial of Service (DDoS) attack that uses publicly accessible open DNS servers to flood a victim with DNS response traffic. An open DNS server is a DNS server which is willing to resolve recursive DNS queries from anyone on the Internet.

In a DNS amplification attack, an attacker sends a DNS name lookup request to an open DNS server with the source address spoofed as the victim's address. When the DNS server sends the DNS record response, it is sent to the victim. Attackers can request as much information as possible to maximize the amplification effect.

Configure the **Security Option Control** section in the **System > DNS & DDNS > DNS** screen if you suspect the Zyxel Device is being used (either by hackers or by a corrupted open DNS server) in a DNS amplification attack.

Figure 263 System > DNS & DDNS > DNS

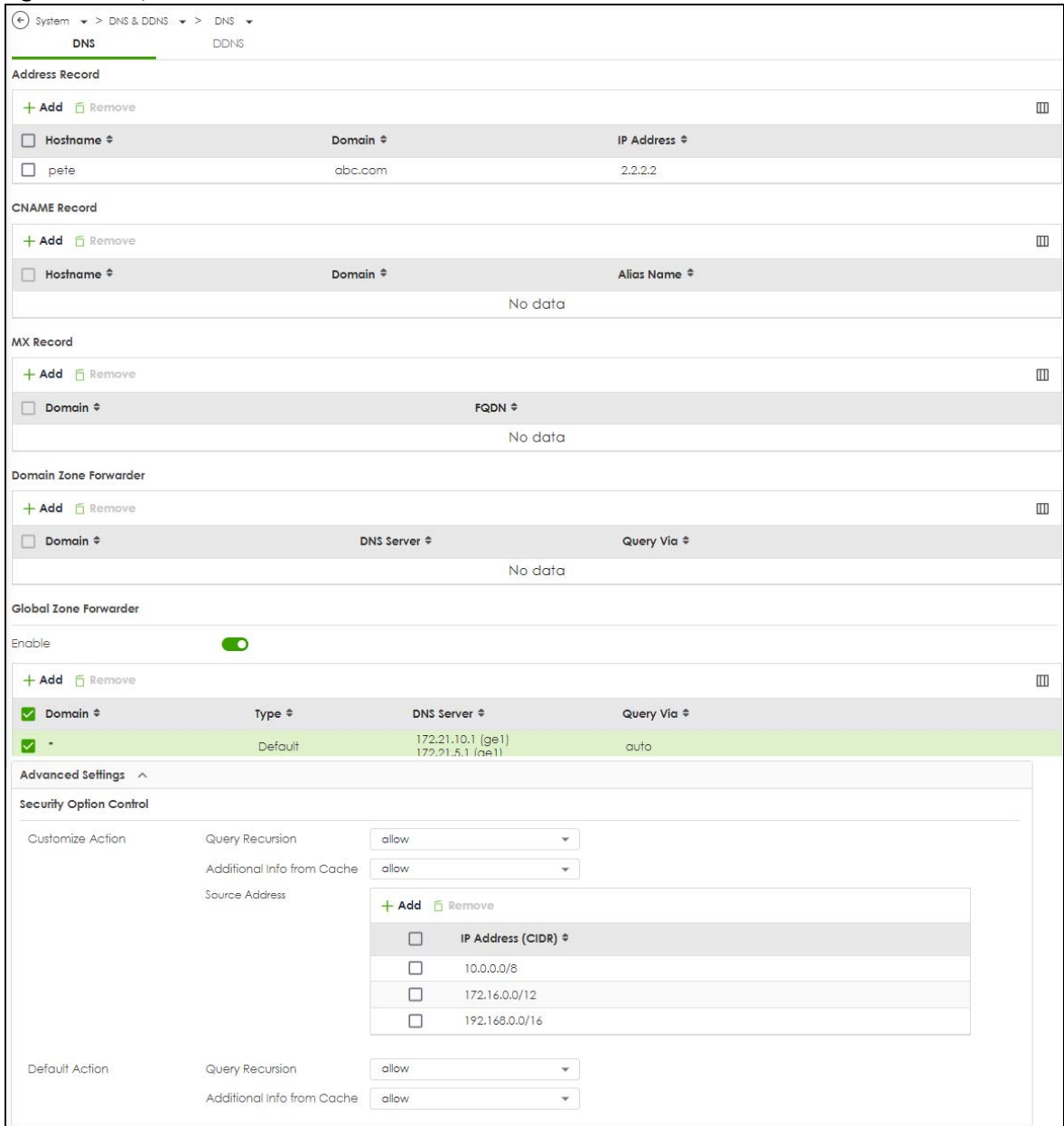

The following table describes the labels in this screen.

Table 211 System > DNS & DDNS > DNS

LABEL	DESCRIPTION
Address/PTR Record	This record specifies the mapping of a Fully-Qualified Domain Name (FQDN) to an IP address. An FQDN consists of a host and domain name. For example, www.zyxel.com.tw is a fully qualified domain name, where "www" is the host, "zyxel" is the third-level domain, "com" is the second-level domain, and "tw" is the top level domain.
Add	Click this to create a new entry.

Table 211 System > DNS & DDNS > DNS (continued)

LABEL	DESCRIPTION
Remove	To remove an entry, select it and click Remove . The Zyxel Device confirms you want to remove it before doing so. Note that subsequent entries move up by one when you take this action.
Edit icon	Double-click an entry or select it to display an Edit icon that allows you to modify the entry's settings.
Hostname	This is the name of the host.
Domain	This is the host's fully qualified domain name.
IP Address	This is the IP address of a host.
CNAME Record	This record specifies an alias for a FQDN. Use this record to bind all subdomains with the same IP address as the FQDN without having to update each one individually, which increases chance for errors. See CNAME Record (Section 26.4.5 on page 434) for more details.
Add	Click this to create a new entry.
Edit	Double-click an entry or select it and click Edit to be able to modify the entry's settings.
Remove	To remove an entry, select it and click Remove . The Zyxel Device confirms you want to remove it before doing so. Note that subsequent entries move up by one when you take this action.
Hostname	This is the name of the host.
Domain	This is the host's fully qualified domain name.
Alias Name	This displays the alias name.
MX Record (for My FQDN)	A MX (Mail eXchange) record identifies a mail server that handles the mail for a particular domain.
Add	Click this to create a new entry.
Edit	Double-click an entry or select it and click Edit to be able to modify the entry's settings.
Remove	To remove an entry, select it and click Remove . The Zyxel Device confirms you want to remove it before doing so. Note that subsequent entries move up by one when you take this action.
Hostname	This is the name of the host.
Domain	This is the domain name where the mail is destined for.
IP/FQDN	This is the IP address or Fully-Qualified Domain Name (FQDN) of a mail server that handles the mail for the domain specified in the field above.
Domain Zone Forwarder	This specifies a DNS server's IP address. The Zyxel Device can query the DNS server to resolve domain zones for features like VPN, DDNS and the time server. When the Zyxel Device needs to resolve a domain zone, it checks it against the domain zone forwarder entries in the order that they appear in this list.
Add	Click this to create a new entry. Select an entry and click Add to create a new entry after the selected entry.
Edit	Double-click an entry or select it and click Edit to be able to modify the entry's settings.
Remove	To remove an entry, select it and click Remove . The Zyxel Device confirms you want to remove it before doing so. Note that subsequent entries move up by one when you take this action.
Move	To change an entry's position in the numbered list, select the method and click Move to display a field to type a number for where you want to put it and press [ENTER] to move the rule to the number that you typed.
Priority	This is the index number of the domain zone forwarder record. The ordering of your rules is important as rules are applied in sequence. A hyphen (-) displays for the default domain zone forwarder record. The default record is not configurable. The Zyxel Device uses this default record if the domain zone that needs to be resolved does not match any of the other domain zone forwarder records.

Table 211 System > DNS & DDNS > DNS (continued)

LABEL	DESCRIPTION
Domain	A domain zone is a fully qualified domain name without the host. For example, zyxel.com.tw is the domain zone for the www.zyxel.com.tw fully qualified domain name. A "*" means all domain zones.
Type	This displays whether the DNS server IP address is assigned by the ISP dynamically through a specified interface or configured manually (User-defined).
DNS Server	This is the IP address of a DNS server. This field displays N/A if you have the Zyxel Device get a DNS server IP address from the ISP dynamically but the specified interface is not active.
Query Via	This is the interface through which the Zyxel Device sends DNS queries to the entry's DNS server. If the Zyxel Device connects through a VPN tunnel, tunnel displays.
Security Option Control	Click the arrow in the Advanced Settings field to display this part of the screen. There are two control policies: Default Action and Customize Action .
Query Recursion	This displays if the Zyxel Device is allowed or denied to forward DNS client requests to DNS servers for resolution.
Additional Info from Cache	This displays if the Zyxel Device is allowed or denied to cache Resource Records (RR) obtained from previous DNS queries.
Source Address	These are the object addresses used in the control policy. RFC1918 refers to private IP address ranges. It can be modified in Object > Address .

26.4.3 Address/PTR Record

An address record contains the mapping of a Fully-Qualified Domain Name (FQDN) to an IP address.

The Zyxel Device allows you to configure address records about the Zyxel Device itself or another device. This way you can keep a record of DNS names and addresses that people on your network may use frequently. If the Zyxel Device receives a DNS query for an FQDN for which the Zyxel Device has an address record, the Zyxel Device can send the IP address in a DNS response without having to query a DNS name server.

A PTR (pointer) record is also called a reverse record or a reverse lookup record. It is a mapping of an IP address to a domain name.

26.4.4 Adding an Address/PTR Record

Click the **Add** icon in the **Address/PTR Record** table to add an IPv4 address/PTR record.

Figure 264 System > DNS & DDNS > DNS > Address/PTR Record > Add

The screenshot shows the 'Address/PTR Record' configuration page. At the top, there are three buttons: '+ Add', 'Edit', and 'Remove'. Below these is a table with three columns: 'Hostname', 'Domain', and 'IP Address'. The 'Hostname' column has a checkbox. The 'Domain' column has a dropdown menu. The 'IP Address' column has a text input field. There are red exclamation mark icons next to the 'Domain' and 'IP Address' fields, indicating a warning or error. At the bottom right of the table, there are green checkmark and red X icons. Below the table, there is a pagination control showing 'Rows per page: 50' and '1 of 1'.

The following table describes the labels in this screen.

Table 212 System > DNS & DDNS > DNS > Address/PTR Record > Add

LABEL	DESCRIPTION
Hostname	Enter the hostname of a server.
Domain	Type a Fully-Qualified Domain Name (FQDN) of a server. An FQDN starts with a host name and continues all the way up to the top-level domain name. For example, www.zyxel.com.tw is a fully qualified domain name, where "www" is the host, "zyxel" is the third-level domain, "com" is the second-level domain, and "tw" is the top level domain. Underscores are not allowed. Use "*" as a prefix in the FQDN for a wildcard domain name (for example, *.example.com).
IP Address	Enter the IP address of the host in dotted decimal notation.
Save changes	Click the Save changes icon to save your customized settings and exit this screen.
Cancel changes	Click the Cancel changes icon to exit this screen without saving.

26.4.5 CNAME Record

A Canonical Name Record or CNAME record is a type of resource record in the Domain Name System (DNS) that specifies that the domain name is an alias of another, canonical domain name. This allows users to set up a record for a domain name which translates to an IP address, in other words, the domain name is an alias of another. This record also binds all the subdomains to the same IP address without having to create a record for each, so when the IP address is changed, all subdomain's IP address is updated as well, with one edit to the record.

For example, the domain name zyxel.com is hooked up to a record named A which translates it to 11.22.33.44. You also have several subdomains, like mail.zyxel.com, ftp.zyxel.com and you want this subdomain to point to your main domain zyxel.com. Edit the IP Address in record A and all subdomains will follow automatically. This eliminates chances for errors and increases efficiency in DNS management.

26.4.6 Adding a CNAME Record

Click the **Add** icon in the **CNAME Record** table to add a record. Use "*" as a prefix for a wildcard domain name. For example *.zyxel.com.

Figure 265 System > DNS & DDNS > DNS > CNAME Record > Add

The screenshot shows the 'CNAME Record' configuration page. At the top, there are three action icons: '+ Add' (green), 'Edit' (pencil), and 'Remove' (trash). Below these is a table with three columns: 'Hostname', 'Domain', and 'Alias name'. Each column has a corresponding input field. The 'Hostname' field is a text box with a red 'i' icon. The 'Domain' field is a dropdown menu with a red 'i' icon. The 'Alias name' field is a text box with a red 'i' icon. To the right of the 'Alias name' field are two icons: a green checkmark and a red 'X'. At the bottom right of the form, there is a pagination control showing 'Rows per page: 50' and '1 of 1'.

The following table describes the labels in this screen.

Table 213 System > DNS & DDNS > DNS > CNAME Record > Add

LABEL	DESCRIPTION
Hostname	Enter the hostname of a server.
Domain	Type a Fully-Qualified Domain Name (FQDN) of a server. An FQDN starts with a host name and continues all the way up to the top-level domain name. For example, www.zyxel.com.tw is a fully qualified domain name, where "www" is the host, "zyxel" is the third-level domain, "com" is the second-level domain, and "tw" is the top level domain. Underscores are not allowed. Use "*" as a prefix in the FQDN for a wildcard domain name (for example, *.example.com).
Alias name	Enter an Alias Name. Use "*" as a prefix in the Alias name for a wildcard domain name (for example, *.example.com).
Save changes	Click the Save changes icon to save your customized settings and exit this screen.
Cancel changes	Click the Cancel changes icon to exit this screen without saving.

26.4.7 MX Record

A MX (Mail eXchange) record indicates which host is responsible for the mail for a particular domain, that is, controls where mail is sent for that domain. If you do not configure proper MX records for your domain or other domain, external email from other mail servers will not be able to be delivered to your mail server and vice versa. Each host or domain can have only one MX record, that is, one domain is mapping to one host.

26.4.8 Adding a MX Record

Click the **Add** icon in the **MX Record** table to add a MX record.

Figure 266 System > DNS & DDNS > DNS > MX Record Add

The screenshot shows the 'MX Record' configuration interface. At the top, there are three icons: '+ Add', 'Edit', and 'Remove'. Below these is a table with three columns: 'Hostname', 'Domain', and 'IP/FQDN'. Each column has an input field. The 'Domain' field has a dropdown arrow. To the right of the input fields is a green bar containing a plus sign icon and a minus sign icon. At the bottom right, there are two icons: a checkmark and an 'X'. At the bottom center, there is a 'Rows per page: 50' dropdown and '1 of 1' with navigation arrows.

The following table describes the labels in this screen.

Table 214 System > DNS & DDNS > MX Record > Add

LABEL	DESCRIPTION
Hostname	Enter the hostname of a server.
Domain	Enter the domain name where the mail is destined for.
IP/FQDN	Enter the IP address or Fully-Qualified Domain Name (FQDN) of a mail server that handles the mail for the domain specified in the field above.
Save changes	Click the Save changes icon to save your customized settings and exit this screen.
Cancel changes	Click the Cancel changes icon to exit this screen without saving.

26.4.9 Domain Zone Forwarder

A domain zone forwarder contains a DNS server's IP address. The Zyxel Device can query the DNS server to resolve domain zones for features like VPN, DDNS and the time server. A domain zone is a fully qualified domain name without the host. For example, zyxel.com.tw is the domain zone for the www.zyxel.com.tw fully qualified domain name.

26.4.10 Adding a Domain Zone Forwarder

Click the **Add** icon in the **Domain Zone Forwarder** table to add a domain zone forwarder record.

Figure 267 System > DNS & DDNS > DNS > Domain Zone Forwarder > Add

The following table describes the labels in this screen.

Table 215 System > DNS & DDNS > DNS > Domain Zone Forwarder > Add

LABEL	DESCRIPTION
Domain	A domain zone is a fully qualified domain name without the host. For example, zyxel.com.tw is the domain zone for the www.zyxel.com.tw fully qualified domain name. For example, whenever the Zyxel Device receives needs to resolve a zyxel.com.tw domain name, it can send a query to the recorded name server IP address. Enter * if all domain zones are served by the specified DNS server(s).
Type	This displays whether the DNS server IP address is assigned by the ISP dynamically through a specified interface or configured manually (User-defined).
DNS Server	Select DNS Server(s) from ISP if your ISP dynamically assigns DNS server information. You also need to select an interface through which the ISP provides the DNS server IP address(es). The interface should be activated and set to be a DHCP client. The fields below display the (read-only) DNS server IP address(es) that the ISP assigns. N/A displays for any DNS server IP address fields for which the ISP does not assign an IP address. Select Public DNS Server if you have the IP address of a DNS server. Enter the DNS server's IP address in the field to the right. The Zyxel Device must be able to connect to the DNS server without using a VPN tunnel. The DNS server could be on the Internet or one of the Zyxel Device's local networks. You cannot use 0.0.0.0. Select Private DNS Server if you have the IP address of a DNS server to which the Zyxel Device connects through a VPN tunnel. Enter the DNS server's IP address in the field to the right. You cannot use 0.0.0.0.
Query Via	Use the Query Via field to select the interface through which the Zyxel Device sends DNS queries to a DNS server.
Save changes	Click the Save changes icon to save your customized settings and exit this screen.
Cancel changes	Click the Cancel changes icon to exit this screen without saving.

26.4.11 Security Option Control

Configure the **Security Option Control** section in the **System > DNS & DDNS > DNS** screen if you suspect the Zyxel Device is being used by hackers in a DNS amplification attack.

One possible strategy would be to deny **Query Recursion** and **Additional Info from Cache** in the default policy and allow **Query Recursion** and **Additional Info from Cache** only from trusted DNS servers identified by address objects and added as members in the customized policy.

26.4.12 Editing a Security Option Control

Use this screen to change **allow** or **deny** actions for **Query Recursion** and **Additional Info from Cache**.

Figure 268 System > DNS & DDNS > DNS > Security Option Control

The screenshot shows the 'Security Option Control' configuration page. It includes sections for 'Customize Action' and 'Default Action' for 'Query Recursion' and 'Additional Info from Cache'. The 'Source Address' section features a table of IP address objects with checkboxes for selection. A confirmation dialog box is present in the bottom right corner.

LABEL	DESCRIPTION
Query Recursion	Choose if the Zyxel Device is allowed or denied to forward DNS client requests to DNS servers for resolution. This can apply to specific open DNS servers using the address objects in a customized rule.
Additional Info from Cache	Choose if the Zyxel Device is allowed or denied to cache Resource Records (RR) obtained from previous DNS queries.
Source Address	This field displays address objects created in Object > Address . Select one or more address object(s) to have it (them) to apply to this rule. For example, you could specify an open DNS server suspect of sending compromised resource records by adding an address object for that server to the member list.
Apply	Click Apply to save your customized settings and exit this screen.
Cancel	Click Cancel to return the screen to its last-saved settings.

The following table describes the labels in this screen.

Table 216 System > DNS & DDNS > DNS > Security Option Control

LABEL	DESCRIPTION
Query Recursion	Choose if the Zyxel Device is allowed or denied to forward DNS client requests to DNS servers for resolution. This can apply to specific open DNS servers using the address objects in a customized rule.
Additional Info from Cache	Choose if the Zyxel Device is allowed or denied to cache Resource Records (RR) obtained from previous DNS queries.
Source Address	This field displays address objects created in Object > Address . Select one or more address object(s) to have it (them) to apply to this rule. For example, you could specify an open DNS server suspect of sending compromised resource records by adding an address object for that server to the member list.
Apply	Click Apply to save your customized settings and exit this screen.
Cancel	Click Cancel to return the screen to its last-saved settings.

26.4.13 The DDNS Screen

The **DDNS** screen provides a summary of all DDNS domain names and their configuration. In addition, this screen allows you to add new domain names, edit the configuration for existing domain names, and delete domain names. Click **System > DNS & DDNS > DDNS** to open the following screen.

Figure 269 System > DNS & DDNS > DDNS

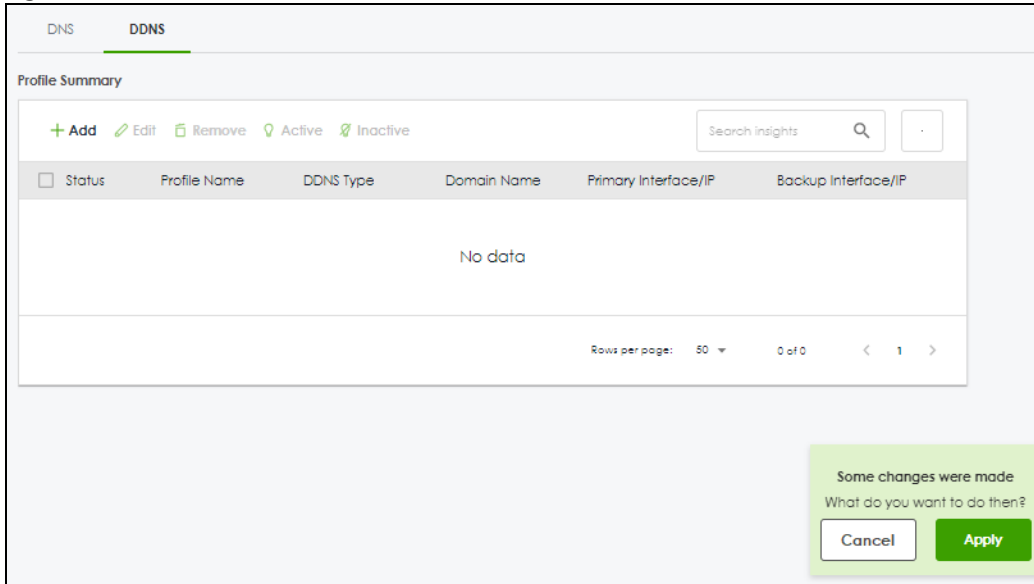

The following table describes the labels in this screen.

Table 217 System > DNS & DDNS > DDNS

LABEL	DESCRIPTION
Add	Click this to create a new entry.
Edit	Double-click an entry or select it and click Edit to open a screen where you can modify the entry's settings.
Remove	To remove an entry, select it and click Remove . The Zyxel Device confirms you want to remove it before doing so.
Activate	To turn on an entry, select it and click Activate .
Inactivate	To turn off an entry, select it and click Inactivate .
Status	This icon is lit when the entry is active and dimmed when the entry is inactive.
Profile Name	This field displays the descriptive profile name for this entry.
DDNS Type	This field displays which DDNS service you are using.
Domain Name	This field displays each domain name the Zyxel Device can route.
Primary Interface/IP	This field displays the interface to use for updating the IP address mapped to the domain name followed by how the Zyxel Device determines the IP address for the domain name. from interface - The IP address comes from the specified interface. auto detected -The DDNS server checks the source IP address of the packets from the Zyxel Device for the IP address to use for the domain name. custom - The IP address is static.

Table 217 System > DNS & DDNS > DDNS (continued)

LABEL	DESCRIPTION
Backup Interface/IP	<p>This field displays the alternate interface to use for updating the IP address mapped to the domain name followed by how the Zyxel Device determines the IP address for the domain name. The Zyxel Device uses the backup interface and IP address when the primary interface is disabled, its link is down or its connectivity check fails.</p> <p>from interface - The IP address comes from the specified interface.</p> <p>auto detected -The DDNS server checks the source IP address of the packets from the Zyxel Device for the IP address to use for the domain name.</p> <p>custom - The IP address is static.</p>
Apply	Click this button to save your changes to the Zyxel Device.
Cancel	Click this button to return the screen to its last-saved settings.

26.4.14 The DDNS Add/Edit Screen

The **DDNS Add/Edit** screen allows you to add a domain name to the Zyxel Device or to edit the configuration of an existing domain name. Click **System > DNS & DDNS > DDNS** and then an **Add** or **Edit** icon to open this screen.

Figure 270 System > DNS & DDNS > DDNS > Add/Edit

General Settings

Enable Profile

Profile Name
This field is required.

DDNS Type DynDNS

HTTPS

DDNS Account

Username
This field is required.

Password
This field is required.

Retype to Confirm

DDNS Setting

Domain
The value should be an FQDN.

Primary Address

Interface ge1 (WAN)

IP Address Interface Auto Custom IP
 Public IP **i**

Backup Address

Interface ge2 (WAN)

IP Address Interface Auto Custom IP
 Public IP **i**

Enable Checking Public IP

Checking Public IP URL
It cannot exceed 255 characters. It should be a URL address in the format "http(s)://domain".

Check Period (5-1440 Minute)
This field is required.

Advanced Settings ^

Enable Wildcard

Mail Exchanger (Optional)

Backup Mail Exchanger

Some changes were made
What do you want to do then?

The following table describes the labels in this screen.

Table 218 System > DNS & DDNS > DDNS > Add/Edit

LABEL	DESCRIPTION
Enable Profile	Slide the switch to the right to use this DDNS entry.
Profile Name	When you are adding a DDNS entry, type a descriptive name for this DDNS entry in the Zyxel Device. You may use 1-31 alphanumeric characters, underscores(_), or dashes (-), but the first character cannot be a number. This value is case-sensitive. This field is read-only when you are editing an entry.
DDNS Type	Select the type of DDNS service you are using. Select User custom to create your own DDNS service and configure the DDNS Server URL Hostname , URL Path , and Additional DDNS Options fields below.
HTTPS	Enable this to encrypt traffic using SSL (port 443), including traffic with username and password, to the DDNS server. Not all DDNS providers support this option.
Username	Type the user name used when you registered your domain name. You can use up to 31 alphanumeric characters and (:_.-@). Spaces are not allowed. For a Dynu DDNS entry, this user name is the one you use for logging into the service, not the name recorded in your personal information in the Dynu website.
Password	Type the password provided by the DDNS provider. You can use up to 64 alphanumeric characters and the underscore. Spaces are not allowed. Your password will be encrypted when you configure this field.
Retype to Confirm	Type the password again to confirm it.
DDNS Settings	
Domain	Type the domain name you registered. You can use up to 255 characters.
Primary Address	Use these fields to set how the Zyxel Device determines the IP address that is mapped to your domain name in the DDNS server. The Zyxel Device uses the Backup Address if the interface specified by these settings is not available.
Interface	Select the interface to use for updating the IP address mapped to the domain name. Select Any to let the domain name be used with any interface.
IP Address	The options available in this field vary by DDNS provider. Interface -The Zyxel Device uses the IP address of the specified interface. This option appears when you select a specific interface in the Primary Binding Address Interface field. Auto - If the interface has a dynamic IP address, the DDNS server checks the source IP address of the packets from the Zyxel Device for the IP address to use for the domain name. You may want to use this if there are one or more NAT routers between the Zyxel Device and the DDNS server. Note: The Zyxel Device may not determine the proper IP address if there is an HTTP proxy server between the Zyxel Device and the DDNS server. Custom IP - If you have a static IP address, you can select this to use it for the domain name. The Zyxel Device still sends the static IP address to the DDNS server. Type the IP address in the user defined field or you can select an address object to use for the domain name. Public IP - Select this if your Zyxel Device is behind a NAT router, and the NAT router has a public WAN IP address. The DDNS provider will use the public WAN IP address of the NAT router for domain name mapping of the Zyxel Device.
Backup Address	Use these fields to set an alternate interface to map the domain name to when the interface specified by the Primary Interface settings is not available.

Table 218 System > DNS & DDNS > DDNS > Add/Edit (continued)

LABEL	DESCRIPTION
Interface	Select the interface to use for updating the IP address mapped to the domain name. Select Any to let the domain name be used with any interface. Select None to not use a backup address.
IP Address	<p>The options available in this field vary by DDNS provider.</p> <p>Interface -The Zyxel Device uses the IP address of the specified interface. This option appears when you select a specific interface in the Backup Binding Address Interface field.</p> <p>Auto -The DDNS server checks the source IP address of the packets from the Zyxel Device for the IP address to use for the domain name. You may want to use this if there are one or more NAT routers between the Zyxel Device and the DDNS server.</p> <p>Note: The Zyxel Device may not determine the proper IP address if there is an HTTP proxy server between the Zyxel Device and the DDNS server.</p> <p>Custom IP - If you have a static IP address, you can select this to use it for the domain name. The Zyxel Device still sends the static IP address to the DDNS server. Type the IP address in the user defined field or you can select an address object to use for the domain name.</p> <p>Public IP - Select this if your Zyxel Device is behind a NAT router, and the NAT router has a public WAN IP address. The DDNS provider will use the public WAN IP address of the NAT router for domain name mapping of the Zyxel Device.</p>
Enable Checking Public IP	
Checking Public IP URL	Type the URL the Zyxel Device uses to check its public WAN IP address for DDNS updates. Use "http://" or "https://" followed by up to 255 characters (a-zA-Z0-9/?@=.&_). This field is only available when the IP Address is Public IP .
Check Period	Type the number of minutes between URL check attempts. Enter a number between 5 and 1440. This field is only available when the IP Address is Public IP .
URL Hostname	This field is only available when the DDNS Type is User Custom . Type the FQDN of the server that will host the DDSN service.
URL Path	This field is only available when the DDNS Type is User Custom . Type the URL that can be used to access the server that will host the DDSN service.
Additional DDNS Options	<p>These are the options supported at the time of writing:</p> <ul style="list-style-type: none"> • dyndns_system to specify the DYNDNS Server type - for example, dyndns@dyndns.org • ip_server_name which should be the URL to get the server's public IP address - for example, http://myip.easylife.tw/
Advanced Settings	Click the arrow in the Advanced Settings field to show the following options.
Enable Wildcard	Enable the wildcard feature to alias subdomains to be aliased to the same IP address as your (dynamic) domain name. This feature is useful if you want to be able to use, for example, www.yourhost.dyndns.org and still reach your hostname.
Mail Exchanger	<p>DynDNS can route email for your domain name to a mail server (called a mail exchanger). For example, DynDNS routes email for john-doe@yourhost.dyndns.org to the host record specified as the mail exchanger.</p> <p>If you are using this service, type the host record of your mail server here. Otherwise leave the field blank.</p> <p>See www.dyndns.org for more information about mail exchangers.</p>
Backup Mail Exchanger	Select this check box if you are using DynDNS's backup service for email. With this service, DynDNS holds onto your email if your mail server is not available. Once your mail server is available again, the DynDNS server delivers the mail to you. See www.dyndns.org for more information about this service.

Table 218 System > DNS & DDNS > DDNS > Add/Edit (continued)

LABEL	DESCRIPTION
Apply	Click this button to save your changes to the Zyxel Device.
Cancel	Click this button to return the screen to its last-saved settings.

26.5 SNMP

Simple Network Management Protocol is a protocol used for exchanging management information between network devices. Your Zyxel Device supports SNMP agent functionality, which allows a manager station to manage and monitor the Zyxel Device through the network. The Zyxel Device supports SNMP version one (SNMPv1), version two (SNMPv2c) and version 3 (SNMPv3). The next figure illustrates an SNMP management operation.

Figure 271 SNMP Management Model

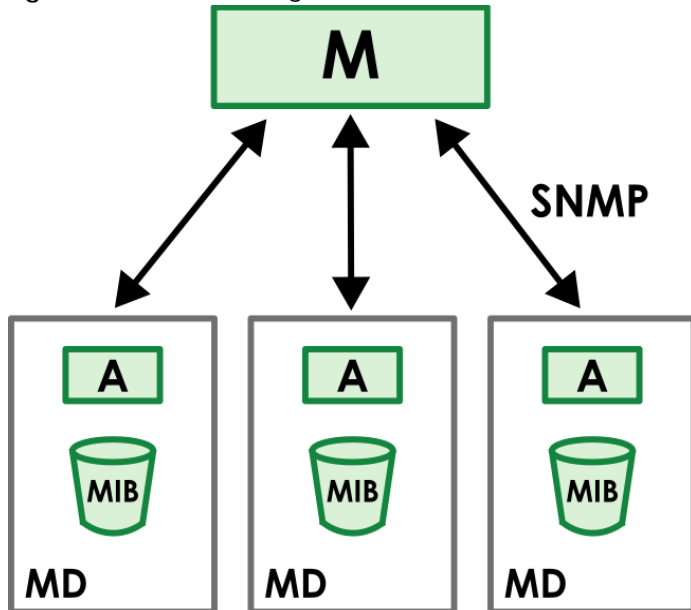

An SNMP managed network consists of two main types of component: agents and a manager.

An agent is a management software module that resides in a managed device (the Zyxel Device). An agent translates the local management information from the managed device into a form compatible with SNMP. The manager is the console through which network administrators perform network management functions. It executes applications that control and monitor managed devices.

The managed devices contain object variables/managed objects that define each piece of information to be collected about a device. Examples of variables include such as number of packets received, node port status etc. A Management Information Base (MIB) is a collection of managed objects. SNMP allows a manager and agents to communicate for the purpose of accessing these objects.

SNMP itself is a simple request/response protocol based on the manager/agent model. The manager issues a request and the agent returns responses using the following protocol operations:

- Get - Allows the manager to retrieve an object variable from the agent.

- GetNext - Allows the manager to retrieve the next object variable from a table or list within an agent. In SNMPv1, when a manager wants to retrieve all elements of a table from an agent, it initiates a Get operation, followed by a series of GetNext operations.
- Set - Allows the manager to set values for object variables within an agent.
- Trap - Used by the agent to inform the manager of some events.

26.5.1 SNMPv3 and Security

SNMPv3 enhances security for SNMP management using authentication and encryption. SNMP managers can be required to authenticate with agents before conducting SNMP management sessions.

Security can be further enhanced by encrypting the SNMP messages sent from the managers. Encryption protects the contents of the SNMP messages. When the contents of the SNMP messages are encrypted, only the intended recipients can read them.

26.5.2 Supported MIBs

The Zyxel Device supports MIB II that is defined in RFC-1213 and RFC-1215. The Zyxel Device also supports private MIBs (zywall.mib and zyxel-zywall-ZLD-Common.mib) to collect information about CPU and memory usage and VPN total throughput. The focus of the MIBs is to let administrators collect statistical data and monitor status and performance. You can download the Zyxel Device's MIBs from www.zyxel.com.

26.5.3 SNMP Traps

The Zyxel Device will send traps to the SNMP manager when any one of the following events occurs.

Table 219 SNMP Traps

OBJECT LABEL	OBJECT ID	DESCRIPTION
Cold Start	1.3.6.1.6.3.1.1.5.1	This trap is sent when the Zyxel Device is turned on or an agent restarts.
linkDown	1.3.6.1.6.3.1.1.5.3	This trap is sent when the Ethernet link is down.
linkUp	1.3.6.1.6.3.1.1.5.4	This trap is sent when the Ethernet link is up.
authenticationFailure	1.3.6.1.6.3.1.1.5.5	This trap is sent when an SNMP request comes from non-authenticated hosts.
vpnTunnelDisconnected	1.3.6.1.4.1.890.1.6.22.2.3	This trap is sent when an IPSec VPN tunnel is disconnected.
vpnTunnelName	1.3.6.1.4.1.890.1.6.22.2.2.1.1	This trap is sent along with the vpnTunnelDisconnected trap. This trap carries the disconnected tunnel's IPSec SA name.
vpnIKEName	1.3.6.1.4.1.890.1.6.22.2.2.1.2	This trap is sent along with the vpnTunnelDisconnected trap. This trap carries the disconnected tunnel's IKE SA name.
vpnTunnelSPI	1.3.6.1.4.1.890.1.6.22.2.2.1.3	This trap is sent along with the vpnTunnelDisconnected trap. This trap carries the security parameter index (SPI) of the disconnected VPN tunnel.

26.5.4 Configuring SNMP

To change your Zyxel Device's SNMP settings, click **System > SNMP** tab. The screen appears as shown. Use this screen to configure your SNMP settings, including from which zones SNMP can be used to access the Zyxel Device. You can also specify from which IP addresses the access can come.

Figure 272 System > SNMP

General Settings

SNMP

SNMP Port

SNMP V1/V2C

SNMP V1

SNMP V2C

SNMP Community

Community 1

Community 2

Trap

Destination (Optional)

Community (Optional)

Note

The community string of the Trap is not mandatory. If filled in, it must be consistent with the string of SNMP community 1 or community 2.

SNMP V3

SNMP V3

SNMP V3 User Configuration

+ Add Edit Remove Search insights

User	Authentication	Privacy
No data		

The following table describes the labels in this screen.

Table 220 System > SNMP

LABEL	DESCRIPTION
SNMP	Enable this to allow to access the Zyxel Device using this service.
Server Port	The SSH port is 161 by default. You may change the server port number for a service if needed, however you must use the same port number in order to use that service for remote management.
SNMP V1	SNMP version 1 is a basic protocol used for network management, enabling devices to communicate status and performance data to a central management system. The SNMP version on the Zyxel Device must match the version on the SNMP manager.
SNMP V2C	SNMP V2C improves on SNMPv1 with enhanced performance, error handling, and support for bulk data retrieval, using community-based security for network management. Select the SNMP version for the Zyxel Device. The SNMP version on the Zyxel Device must match the version on the SNMP manager.
SNMP Community	

Table 220 System > SNMP (continued)

LABEL	DESCRIPTION
Community 1/2	Enter the community, which is the password for the incoming Get or Set requests from the management station. You can use up to 64 single-byte characters, including 0-9a-zA-Z_-. . The first character cannot be a period (.).
Community 1/2 Authorization	Select the access rights to the community. <ul style="list-style-type: none"> • read-write: A read-write community string enables users to both retrieve and modify device data, allowing for comprehensive network management and configuration. • read-only: A read-only community string allows the retrieval of device data for monitoring but prevents any configuration changes
Trap	
Destination	Type the IP address of the station to send your SNMP traps to.
Community	A Trap community in SNMP is a string used to define the group or community to which an SNMP agent sends trap messages (alerts). It acts as a password-like identifier, ensuring that trap notifications are sent to authorized network management systems (NMS) that belong to the specified community. The community string of the Trap is not mandatory. If filled in, it must be consistent with the string of SNMP community 1 or community 2.
SNMPV3	Select the SNMP version for the Zyxel Device. The SNMP version on the Zyxel Device must match the version on the SNMP manager. SNMPv3 (RFCs 3413 to 3415) provides secure access by authenticating and encrypting data packets over the network. The Zyxel Device uses your login password as the SNMPv3 authentication and encryption passphrase. Note: Your login password must consist of at least 8 printable characters for SNMPv3. An error message will display if your login password has fewer characters.
Add	Click this to create a new entry. Select an entry and click Add to create a new entry after the selected entry.
Edit	Double-click an entry or select it and click Edit to be able to modify the entry's settings.
Remove	To remove an entry, select it and click Remove . The Zyxel Device confirms you want to remove it before doing so. Note that subsequent entries move up by one when you take this action.
User	This displays the name of the user object to be sent to the SNMP manager along with the SNMP v3 trap.
Authentication	This displays the authentication algorithm used for this entry. MD5 (Message Digest 5) and SHA (Secure Hash Algorithm) are hash algorithms used to authenticate SNMP data. SHA authentication is generally considered stronger than MD5, but is slower.
Privacy	This displays the encryption method for SNMP communication from this user. Methods available are: <ul style="list-style-type: none"> • DES - Data Encryption Standard is a widely used (but breakable) method of data encryption. It applies a 56-bit key to each 64-bit block of data. • AES - Advanced Encryption Standard is another method for data encryption that also uses a secret key. AES applies a 128-bit key to 128-bit blocks of data.
Apply	Click Apply to save your changes back to the Zyxel Device.
Cancel	Click Cancel to return the screen to its last-saved settings.

26.5.5 Add SNMP V3 User

Click **Add** under **SNMP V3 User Configuration** in **System > SNMP** to create an SNMPv3 user for authentication with managers using SNMP v3. Use the username and password of the login accounts you specify in this screen to create accounts on the SNMP v3 manager.

Figure 273 System > SNMP V3 > Add

The screenshot shows a configuration form for adding a new SNMP V3 user. The form includes the following fields and options:

- *User:** A text input field.
- *Password:** A text input field with a toggle icon for password visibility.
- User Authentication:** A dropdown menu currently set to 'md5'.
- Privacy:** A dropdown menu currently set to 'aes'.
- Group:** A dropdown menu currently set to 'read-only'.

A green notification box at the bottom right of the form contains the text: "Some changes were made. What do you want to do then?" Below this text are two buttons: "Cancel" and "Apply".

The following table describes the labels in this screen.

Table 221 System > SNMPV3 > Add

LABEL	DESCRIPTION
User	Specify the username of a login account on the Zyxel Device. The associated password is used in authentication algorithms and encryption methods. It must begin with a letter and cannot exceed 31 characters. The valid characters are [0-9][a-z][A-Z][_].
Password	Enters a password consists of eight characters. Your login password must consist of at least 8 printable characters for SNMPV3.
User Authentication	Select an authentication algorithm. MD5 (Message Digest 5) and SHA (Secure Hash Algorithm) are hash algorithms used to authenticate SNMP data. SHA authentication is generally considered stronger than MD5, but is slower.
Privacy	Specify the encryption method for SNMP communication from this user. You can choose one of the following: <ul style="list-style-type: none"> DES - Data Encryption Standard is a widely used (but breakable) method of data encryption. It applies a 56-bit key to each 64-bit block of data. AES - Advanced Encryption Standard is another method for data encryption that also uses a secret key. AES applies a 128-bit key to 128-bit blocks of data.
Group	Select the access rights to MIBs: <ul style="list-style-type: none"> read-write - The associated user can create and edit the MIBs on the Zyxel Device, except the user account. read-only - The associated user can only collect information from the Zyxel Device.
Apply	Click Apply to save your changes back to the Zyxel Device.
Cancel	Click Cancel to return the screen to its last-saved settings.

26.6 Notification

Use these screens to configure the mail server settings and alert settings.

26.6.1 The Mail Server Screen

Use this screen to configure a mail server so you can receive reports and notification emails such as when your password is about to expire. After you configure the screen, you can test the settings in **Maintenance > Diagnostics > Network Tool** and then select **Test Email Server**. See **Log & Report > Email Daily Report** to configure what reports to send and to whom.

Click **System > Notification > Mail Server** to display the following screen.

Figure 274 System > Notification > Mail Server

The following table describes the labels in this screen.

Table 222 System > Notification > Mail Server

LABEL	DESCRIPTION
Mail Server	Type the name or IP address of the outgoing SMTP server.
Port	Enter the same port number here as is on the mail server for mail traffic.
TLS Security	Enable this if the mail server uses Transport Layer Security (TLS) for encrypted communications between the mail server and the Zyxel Device.
STARTTLS	Enable this if the mail server uses SSL or TLS for encrypted communications between the mail server and the Zyxel Device.
Authenticate Server	Enable this if the Zyxel Device authenticates the mail server in the TLS handshake.

Table 222 System > Notification > Mail Server (continued)

LABEL	DESCRIPTION
SMTP Authentication	Select this check box if it is necessary to provide a user name and password to the SMTP server.
User Name	This box is effective when you select the SMTP Authentication check box. Type the user name to provide to the SMTP server when the log is emailed. Use up to 30 characters, including 0-9a-zA-Z@._-
Password	This box is effective when you select the SMTP Authentication check box. Type a password to provide to the SMTP server when the log is emailed. Use 4 to 63 characters, including 0-9a-zA-Z'~!@#\$\$%^&*()_+={} \;:'">'./
Retype	Type the password again to make sure that you have entered is correctly.
Default Sender and Recipient	
Send From	Type the default email address from which the outgoing email is delivered. This address is used in replies. The value should be an email address. It can be up to 83 characters. The valid characters are [a-z][A-Z][/=?^_{ }~w-!#\$%*+]. The entry will be automatically filled into other sender fields in the web configurator and cannot be edited: <ul style="list-style-type: none"> The Email From field in the Log & Report > Email Daily Report. The Send From field in System > Notification > Alert > Event Notification/Log Alert.
Recipient	Enter the email address of the recipient to whom the outgoing email is sent. This is the address that will receive the email. It can be up to 83 characters. The valid characters are [a-z][A-Z][/=?^_{ }~w-!#\$%*+]. The entry will be automatically filled into other recipient fields in the web configurator and can be edited: <ul style="list-style-type: none"> The Email To field in Log & Report > Email Daily Report. The Recipients field in System > Notification > Alert > Event Notification/Log Alert. The Recipients field in Maintenance > Firmware/File Manager > Configuration File.
Send Test Email	Click this button to send an email to the default mail to recipient to test if the email can be successfully received.
Apply	Click Apply to save your changes back to the Zyxel Device.
Cancel	Click Cancel to return the screen to its last-saved settings.

26.6.2 The Alert Screen

Click **System > Notification > Alert** to display the following screen.

Figure 275 System > Notification > Alert

#	Status	Event	Action	Description
1	Inactive	Admin Login Fail, Device Shutdown, Factory Reset, USB Disk Full Alert, Device HA Failover	Email	

#	Status	Category	Description
1	Active	Security Policy Control, DoS Prevention, Session Control	

The following table describes the labels in this screen.

Table 223 System > Notification > Alert

LABEL	DESCRIPTION
Event Notification	
Add	Click this to create a new entry. Select an entry and click Add to create a new entry after the selected entry.
Edit	Double-click an entry or select it and click Edit to open a screen where you can modify the entry's settings.
Remove	To remove an entry, select it and click Remove . The Zyxel Device confirms if you want to remove it before doing so.
Active	To turn on an entry, select it and click Activate .
Inactive	To turn off an entry, select it and click Inactivate .
#	This field is a sequential value and is not associated with any entry.
Status	This field displays the current status of each profile.
Event	This field displays the type(s) of event to create a log or send an email notification.
Action	This field displays the action to take when specified type(s) of events occur: <ul style="list-style-type: none"> • Email: Create a log and send an email notification. • Log: Create a log.
Description	This field displays the profile's description.
Log Alert	
Add	Click this to create a new entry. Select an entry and click Add to create a new entry after the selected entry.
Edit	Double-click an entry or select it and click Edit to open a screen where you can modify the entry's settings.
Remove	To remove an entry, select it and click Remove . The Zyxel Device confirms if you want to remove it before doing so.
Active	To turn on an entry, select it and click Activate .
Inactive	To turn off an entry, select it and click Inactivate .
#	This field is a sequential value and is not associated with any entry.
Status	This field displays the current status of each profile.
Category	This field displays the type(s) of log to send an email notification.
Description	This field displays the profile's description.

26.6.2.1 The Event Notification Add/Edit Screen

Click **System > Notification > Alert > Event Notification Add/Edit** to display the following screen.

Figure 276 System > Notification > Alert > Event Notification Add/Edit

System > Notification > Alert

General Settings

Enable

Event
 This field is required.

Description

Alert Inhibition **i**

Interval (5-1440 minutes)

Action

Email Subject

Send From koala@zyxel.com **i**

Recipients
 The value should be an email address. It cannot exceed 83 characters. The valid characters are [a-z][A-Z][/=/?^_{|}~w-!#\$%*+].

+ Add

Some changes were made
What do you want to do then?
Cancel **Apply**

The following table describes the labels in this screen.

Table 224 System > Notification > Alert > Event Notification Add/Edit

LABEL	DESCRIPTION
Enable	Enable this to create a log or send an email notification when the specified type(s) of event occur.
Event	Select the type(s) of event to create a log or send an email notification.
Description	Enter a description of this policy to identify it. You can use up to 512 single-byte characters, special characters and spaces are allowed.
Alert Inhibition	Enable this to temporarily stop receiving notifications for CPU Usage over Threshold , Memory Usage over Threshold , Temperature too high (CPU, Switch, Board) , USB Disk Full Alert , USB Disk Full Warning , and Storage Usage over Threshold . Other event types will not be affected.
Interval	Specify how long to stop receiving the above notifications. The range is from 5 to 1440 minutes. The default is 60 minutes.
Action	Select the action to take when specified type(s) of event occur: <ul style="list-style-type: none"> Email: Create a log and send an email notification when the selected type(s) of event occur. Log: Create a log when the selected type(s) of event occur.
Email Subject	Enter the subject line for the outgoing email with 1-128 characters. It may consist of letters, numbers, and the following special characters: '()+,./:=?;!*#@\$_%-. If you leave this field blank, the email subject will be the event name(s).
Send From	Enter the email address from which the outgoing email is delivered. This address is used in replies.

Table 224 System > Notification > Alert > Event Notification Add/Edit (continued)

LABEL	DESCRIPTION
Recipients	Enter up to 83 characters for the email address of the receiver. It may consist of letters, numbers, and the following special characters: /=?^_{}~w-!#\$%*+. You can enter up to five recipients.
Cancel	Click Cancel to return the screen to its last-saved settings.
Apply	Click Apply to save your settings to the Zyxel Device.

26.6.2.2 The Log Alert Add/Edit Screen

Click **System > Notification > Alert > Log Alert Add/Edit** to display the following screen.

Figure 277 System > Notification > Alert > Log Alert Add/Edit

The following table describes the labels in this screen.

Table 225 System > Notification > Alert > Log Alert Add/Edit

LABEL	DESCRIPTION
Send Alert	Enable this to send an email notification when the specified type(s) of log occur.
Category	Select the type(s) of log to send an email notification.
Description	Enter a description of this policy to identify it. You can use up to 512 single-byte characters, special characters and spaces are allowed.
Email Subject	Enter the subject line for the outgoing email with 1-128 characters. It may consist of letters, numbers, and the following special characters: '()+,./:;!*#@\$_%-
Send From	Enter the email address from which the outgoing email is delivered. This address is used in replies.
Recipients	Enter up to 83 characters for the email address of the receiver. It may consist of letters, numbers, and the following special characters: /=?^_{}~w-!#\$%*+. You can enter up to five recipients.

Table 225 System > Notification > Alert > Log Alert Add/Edit

LABEL	DESCRIPTION
Cancel	Click Cancel to return the screen to its last-saved settings.
Apply	Click Apply to save your settings to the Zyxel Device.

26.7 Certificate Overview

The Zyxel Device can use certificates (also called digital IDs) to authenticate users. Certificates are based on public-private key pairs. A certificate contains the certificate owner's identity and public key. Certificates provide a way to exchange public keys for use in authentication.

26.7.1 What You Need to Know

When using public-key cryptology for authentication, each host has two keys. One key is public and can be made openly available. The other key is private and must be kept secure.

These keys work like a handwritten signature (in fact, certificates are often referred to as "digital signatures"). Only you can write your signature exactly as it should look. When people know what your signature looks like, they can verify whether something was signed by you, or by someone else. In the same way, your private key "writes" your digital signature and your public key allows people to verify whether data was signed by you, or by someone else. This process works as follows.

- 1 Tim wants to send a message to Jenny. He needs her to be sure that it comes from him, and that the message content has not been altered by anyone else along the way. Tim generates a public key pair (one public key and one private key).
- 2 Tim keeps the private key and makes the public key openly available. This means that anyone who receives a message seeming to come from Tim can read it and verify whether it is really from him or not.
- 3 Tim uses his private key to sign the message and sends it to Jenny.
- 4 Jenny receives the message and uses Tim's public key to verify it. Jenny knows that the message is from Tim, and that although other people may have been able to read the message, no-one can have altered it (because they cannot re-sign the message with Tim's private key).
- 5 Additionally, Jenny uses her own private key to sign a message and Tim uses Jenny's public key to verify the message.

The Zyxel Device uses certificates based on public-key cryptology to authenticate users attempting to establish a connection, not to encrypt the data that you send after establishing a connection. The method used to secure the data that you send through an established connection depends on the type of connection. For example, a VPN tunnel might use the triple DES encryption algorithm.

The certification authority uses its private key to sign certificates. Anyone can then use the certification authority's public key to verify the certificates.

A certification path is the hierarchy of certification authority certificates that validate a certificate. The Zyxel Device does not trust a certificate if any certificate on its path has expired or been revoked.

Certification authorities maintain directory servers with databases of valid and revoked certificates. A directory of certificates that have been revoked before the scheduled expiration is called a CRL (Certificate Revocation List). The Zyxel Device can check a peer's certificate against a directory server's list of revoked certificates. The framework of servers, software, procedures and policies that handles keys is called PKI (public-key infrastructure).

Advantages of Certificates

Certificates offer the following benefits.

- The Zyxel Device only has to store the certificates of the certification authorities that you decide to trust, no matter how many devices you need to authenticate.
- Key distribution is simple and very secure since you can freely distribute public keys and you never need to transmit private keys.

Self-signed Certificates

You can have the Zyxel Device act as a certification authority and sign its own certificates.

Factory Default Certificate

The Zyxel Device generates its own unique self-signed certificate when you first turn it on. This certificate is referred to in the GUI as the factory default certificate.

Certificate File Formats

Any certificate that you want to import has to be in one of these file formats:

- Binary X.509: This is an ITU-T recommendation that defines the formats for X.509 certificates.
- PEM (Base-64) encoded X.509: This Privacy Enhanced Mail format uses lowercase letters, uppercase letters and numerals to convert a binary X.509 certificate into a printable form.
- Binary PKCS#7: This is a standard that defines the general syntax for data (including digital signatures) that may be encrypted. A PKCS #7 file is used to transfer a public key certificate. The private key is not included. The Zyxel Device currently allows the importation of a PKCS#7 file that contains a single certificate.
- PEM (Base-64) encoded PKCS#7: This Privacy Enhanced Mail (PEM) format uses lowercase letters, uppercase letters and numerals to convert a binary PKCS#7 certificate into a printable form.
- Binary PKCS#12: This is a format for transferring public key and private key certificates. The private key in a PKCS #12 file is within a password-encrypted envelope. The file's password is not connected to your certificate's public or private passwords. Exporting a PKCS #12 file creates this and you must provide it to decrypt the contents when you import the file into the Zyxel Device.

Note: Be careful not to convert a binary file to text during the transfer process. It is easy for this to occur since many programs use text files by default.

26.7.2 Verifying a Certificate

Before you import a trusted certificate into the Zyxel Device, you should verify that you have the correct certificate. You can do this using the certificate's fingerprint. A certificate's fingerprint is a message digest calculated using the MD5 or SHA1 algorithm. The following procedure describes how to check a certificate's fingerprint to verify that you have the actual certificate.

- 1 Browse to where you have the certificate saved on your computer.
- 2 Make sure that the certificate has a ".cer" or ".crt" file name extension.
- 3 Double-click the certificate's icon to open the **Certificate** window. Click the **Details** tab and scroll down to the **Thumbprint Algorithm** and **Thumbprint** fields.

Figure 278 Certificate Details

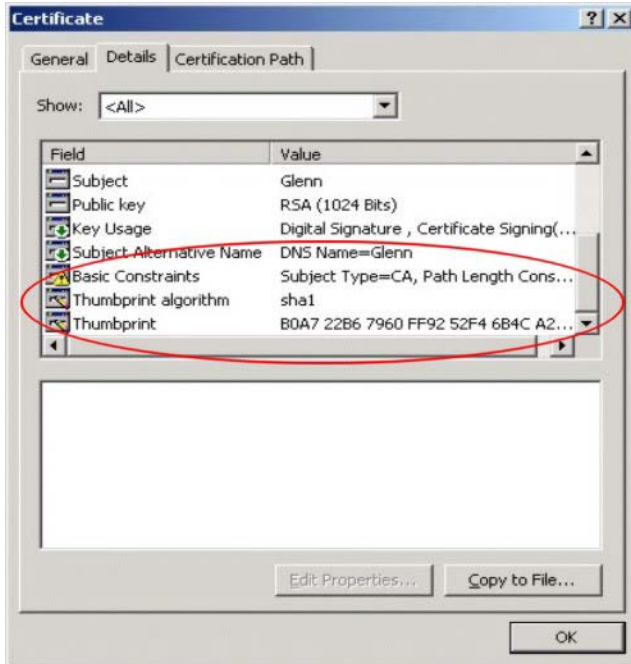

- 4 Use a secure method to verify that the certificate owner has the same information in the **Thumbprint Algorithm** and **Thumbprint** fields. The secure method may vary based on your situation. Possible examples would be over the telephone or through an HTTPS connection.

26.8 My Certificates

Click **System > My Certificates** to open the **My Certificates** screen. This is the Zyxel Device's summary list of certificates and certification requests.

Figure 279 System > My Certificates

My Certificates Setting

+ Add Edit Remove Reference Email Import Export

Search insights

Name	Type	Subject	Issuer	Valid From	Valid To
<input checked="" type="checkbox"/> RemoteAccess-VPN-649	SELF	CN=	CN=	Nov 14 09:05:35 2024 GMT	Nov 12 09:05:35 2034 GMT
<input type="checkbox"/> default	SELF	CN=USG_FLEX_500H_D8ECE56094FE	CN=USG_FLEX_500H_D8ECE56094FE	Nov 8 05:26:48 2024 GMT	Nov 6 05:26:48 2034 GMT

The following table describes the labels in this screen.

Table 226 System > My Certificates

LABEL	DESCRIPTION
Add	Click this to go to the screen where you can have the Zyxel Device generate a certificate or a certification request.
Edit	Double-click an entry or select it and click Edit to open a screen with an in-depth list of information about the certificate.
Remove	The Zyxel Device keeps all of your certificates unless you specifically delete them. Uploading a new firmware or default configuration file does not delete your certificates. To remove an entry, select it and click Remove . The Zyxel Device confirms you want to remove it before doing so. Subsequent certificates move up by one when you take this action.
Reference	Select an entry and click Reference to check which settings use the entry.
Email	<p>Click this to email the selected certificate to the configured email address(es) for SSL or site to site VPN connection establishment. This enables you to establish an connection on your laptops, tablets, or smartphones.</p> <p>Click this and the following screen will appear.</p> <p>Here are the field descriptions:</p> <ul style="list-style-type: none"> • Email Subject: Type the subject line for outgoing email from the Zyxel Device. Enter a email subject text of 1-60 characters. It may consist of letters, numbers, and the following special characters: '()+,./:=?;!*#@\$_%-' • Email To: Type the email address to which the outgoing email is delivered using up to 83 characters. • Email Content: Create the email content in English, and use up to 250 keyboard characters. The special characters listed in the brackets [0-9a-zA-Z!'#\$%&'()*+,-./::<=>@\[\]^_`{ }] are allowed. • Cancel: Click this to return to the previous screen without saving your changes. • Send Email: Click this to send the selected certificate. <p>Figure 280 Email Certificate</p> 
Import	Click Import to open a screen where you can save the certificate of a certification authority that you trust, from your computer to the Zyxel Device.

Table 226 System > My Certificates (continued)

LABEL	DESCRIPTION
Export	<p>Click this and the following screen will appear.</p> <p>Type the selected certificate's password and save the selected certificate to your computer.</p> <p>Figure 281 Export a Certificate</p> 
Name	This field displays the name used to identify this certificate. It is recommended that you give each certificate a unique name.
Type	<p>This field displays what kind of certificate this is.</p> <p>REQ represents a certification request and is not yet a valid certificate. Send a certification request to a certification authority, which then issues a certificate. Use the My Certificate Import screen to import the certificate and replace the request.</p> <p>SELF represents a self-signed certificate.</p> <p>CERT represents a certificate issued by a certification authority.</p>
Subject	This field displays identifying information about the certificate's owner, such as CN (Common Name), OU (Organizational Unit or department), O (Organization or company) and C (Country). It is recommended that each certificate have unique subject information.
Issuer	This field displays identifying information about the certificate's issuing certification authority, such as a common name, organizational unit or department, organization or company and country. With self-signed certificates, this is the same information as in the Subject field.
Valid From	This field displays the date that the certificate becomes applicable.
Valid To	This field displays the date that the certificate expires. The text displays in red and includes an Expired! message if the certificate has expired.
Reference	You cannot delete certificates that any of the Zyxel Device's features are configured to use. Select an entry and click References to open a screen that shows which settings use the entry.

26.8.1 The My Certificates Add Screen

Click **System > My Certificates** and then the **Add** icon to open the following screen. Use this screen to have the Zyxel Device create a self-signed certificate, enroll a certificate with a certification authority or generate a certification request.

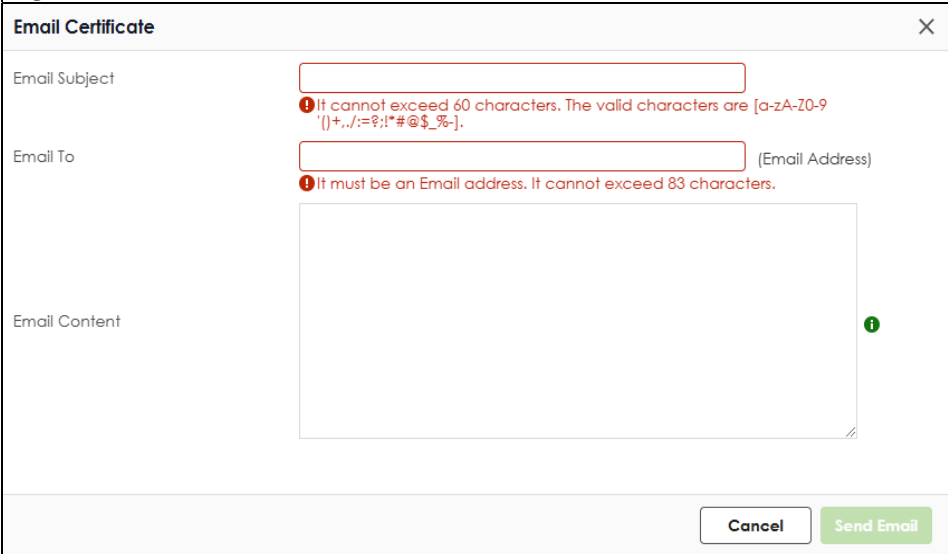
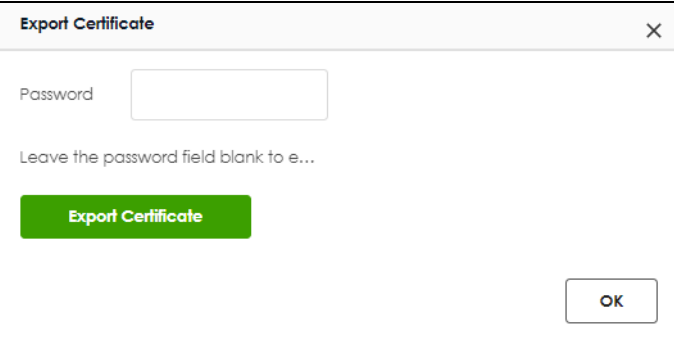
If you configured the **My Certificate > Add** screen to have the Zyxel Device enroll a certificate and the certificate enrollment is not successful, you will not see the certificate you configured in the **My Certificates** screen after you click **Apply**. Make sure that the certification authority information is correct and that your Internet connection is working properly if you want the Zyxel Device to enroll a certificate online.

Figure 282 System > My Certificates > Add

Configuration

Name

Subject Information

Host IP Address

Host Domain Name

Email

Organizational Unit (Optional)

Organization (Optional)

Town (City) (Optional)

State (Province) (Optional)

Country (Optional)

Key Type ▼

Key Length ▼ bits

Lifetimes ▼ Years

Extended Key Usage

Server Authentication

Client Authentication

Ike Intermediate

Enrollment Options

Create a self-signed certificate

Create a certification request and save it locally for later manual enrollment

Some changes were made
What do you want to do then?

The following table describes the labels in this screen.

Table 227 System > My Certificates > Add

LABEL	DESCRIPTION
Name	Type a name to identify this certificate. You can use up to 31 alphanumeric and ;'~!@#\$\$%^&()_+[]{}',.-= characters.
Subject Information	<p>Use these fields to record information that identifies the owner of the certificate. You do not have to fill in every field, although you must specify a Host IP Address, Host Domain Name, or E-Mail. The certification authority may add fields (such as a serial number) to the subject information when it issues a certificate. It is recommended that each certificate have unique subject information.</p> <p>Select a radio button to identify the certificate's owner by IP address, domain name or email address. Type the IP address (in dotted decimal notation), domain name or email address in the field provided. The domain name or email address is for identification purposes only and can be any string.</p> <p>A domain name can be up to 30 characters. You can use alphanumeric characters and periods.</p> <p>An email address can be up to 63 characters. You can use alphanumeric characters, the hyphen, the @ symbol, periods and the underscore.</p>
Organizational Unit	Identify the organizational unit or department to which the certificate owner belongs. You can use up to 31 characters. You can use alphanumeric characters, the hyphen and the underscore.
Organization	Identify the company or group to which the certificate owner belongs. You can use up to 31 characters. You can use alphanumeric characters, the hyphen and the underscore.
Town (City)	Identify the town or city where the certificate owner is located. You can use up to 31 characters. You can use alphanumeric characters, the hyphen and the underscore.
State (Province)	Identify the state or province where the certificate owner is located. You can use up to 31 characters. You can use alphanumeric characters, the hyphen and the underscore.
Country	Enter a two-letter country code to identify the nation where the certificate owner is located.
Key Type	<p>This sets the certificate's encryption algorithm and signature hash algorithm.</p> <p>Encryption algorithms:</p> <ul style="list-style-type: none"> • RSA: Rivest, Shamir and Adleman public-key algorithm. • DSA: Digital Signature Algorithm public-key algorithm. • ECDSA: Elliptic Curve Digital Signature Algorithm. <p>Signature hash algorithms:</p> <ul style="list-style-type: none"> • SHA256 • SHA384 • SHA512 <p>RSA and SHA256 are less secure but more compatible with different clients and applications. ECDSA and SHA512 are the more secure but less compatible.</p>
Key Length	Select a number from the drop-down list box to determine how many bits the key should use (256 to 384). The longer the key, the more secure it is. A longer key also uses more PKI storage space. ECDSA keys are significant shorter than RSA and DSA keys, while offering equal or higher security.
LifeTimes	Select how long the certificate is valid. It can be valid from 1 to 10 years.
Extended Key Usage	
Server Authentication	Select this to have Zyxel Device generate and store a request for server authentication certificate.
Client Authentication	Select this to have Zyxel Device generate and store a request for client authentication certificate.

Table 227 System > My Certificates > Add (continued)

LABEL	DESCRIPTION
IKE Intermediate	Select this to have Zyxel Device generate and store a request for IKE Intermediate authentication certificate.
Create a self-signed certificate	Select this to have the Zyxel Device generate the certificate and act as the Certification Authority (CA) itself. This way you do not need to apply to a certification authority for certificates.
Create a certification request and save it locally for later manual enrollment	Select this to have the Zyxel Device generate and store a request for a certificate. Use the My Certificate Details screen to view the certification request and copy it to send to the certification authority. Copy the certification request from the My Certificate Details screen (see Section 26.8.2 on page 460) and then send it to the certification authority.
Apply	Click Apply to save your changes back to the Zyxel Device.
Cancel	Click Cancel to return the screen to its last-saved settings.

26.8.2 The My Certificates Edit Screen

Click **System > My Certificates** and then the **Edit** icon to open the **My Certificate Edit** screen. You can use this screen to view in-depth certificate information and change the certificate's name.

Figure 283 System > My Certificates > Edit

Certificate Information

Name	default
Version	3
Serial Number	cd:63:01:70:de:c3:f8:7a
Subject	CN = usg60v3-poe_D8ECE55C0D04
Issuer	CN = usg60v3-poe_D8ECE55C0D04
Signature Algorithm	sha256WithRSAEncryption
Valid From	Apr 16 14:54:40 2021 GMT
Valid To	Apr 14 14:54:40 2031 GMT
Key Algorithm	rsaEncryption
Subject Alternative Name	othername:<unsupported>, email:usg60v3-poe_D8ECE55C0D04
Key Usage	Digital Signature, Key Encipherment, Data Encipherment, Certificate Sign
Extended Key Usage	
Basic Constraints	CA:TRUE, pathlen:1

PEM (Base-64) Encoded Format

```
-----BEGIN CERTIFICATE-----
MIIDZzCCakegAwIBAgIJAM1jAXDew/h6MA0GCsqG3lb3DQEBcWUAMCMxITAFBgNV
BAMMGHVzZzYwdjMtcG9lX0Q4RUNFNTVDMEQwND AeFw0yMTA0MTYxNDU0ND BaFw0z
MTA0MTQxNDU0ND BaMCMxITAFBgNVBAMMGHVzZzYwdjMtcG9lX0Q4RUNFNTVDMEQw
NDCCASlwdG9JKoZlhcNAQE8B8QADggEPADCCAQoCggEBBAKx+JcHpgcAXj6u6CP5
HGySlayy+Iwe9O88YKaHKAT9oGszdphrsHRYZ8t2S15X4w8zFUM/s54fCgFMd+2b
w+0o7mU8ywOIPOn3EaGlvvKh4+AShxFw3n+b2oRPT/FpwKy2UDVg7LhFDglZ6la
nJcYAoa957K1HN4k09UgZnpj5wk6f8t4Pnf2yoh2UdSCCKf845mZnN+pXCKUQ
PVsIFUCnKOrXT+rbF8Xv7ykH+bTlwBKuhxbkgj/rV+LI+FuobJZLQMeCQTo+Tluy
Df1YMaW08TS5BP4XDYJRtNUTQDgwwAaeQ7NoHxU78ntx+XizMP5S5h5qdLjC7TR
-----
```

Some changes were made

What do you want to do then?

The following table describes the labels in this screen.

Table 228 System > My Certificates > Edit

LABEL	DESCRIPTION
Name	This field displays the identifying name of this certificate. You can use up to 31 alphanumeric and ;'~!@#\$\$%^&()_+[]{}',.- characters.
Type	This field displays general information about the certificate. CA-signed means that a Certification Authority signed the certificate. Self-signed means that the certificate's owner signed the certificate (not a certification authority). X.509 means that this certificate was created and signed according to the ITU-T X.509 recommendation that defines the formats for public-key certificates.
Version	This field displays the X.509 version number.
Serial Number	This field displays the certificate's identification number given by the certification authority or generated by the Zyxel Device.
Subject	This field displays information that identifies the owner of the certificate, such as Common Name (CN), Organizational Unit (OU), Organization (O), State (ST), and Country (C).

Table 228 System > My Certificates > Edit (continued)

LABEL	DESCRIPTION
Issuer	<p>This field displays identifying information about the certificate's issuing certification authority, such as Common Name, Organizational Unit, Organization and Country.</p> <p>With self-signed certificates, this is the same as the Subject Name field.</p> <p>"none" displays for a certification request.</p>
Signature Algorithm	<p>This field displays the type of algorithm that was used to sign the certificate. The Zyxel Device uses rsa-pkcs1-sha1 (RSA public-private key encryption algorithm and the SHA1 hash algorithm). Some certification authorities may use rsa-pkcs1-md5 (RSA public-private key encryption algorithm and the MD5 hash algorithm).</p>
Valid From	<p>This field displays the date that the certificate becomes applicable. "none" displays for a certification request.</p>
Valid To	<p>This field displays the date that the certificate expires. The text displays in red and includes an Expired! message if the certificate has expired. "none" displays for a certification request.</p>
Key Algorithm	<p>This field displays the type of algorithm that was used to generate the certificate's key pair (the Zyxel Device uses RSA encryption) and the length of the key set in bits (1024 bits for example).</p>
Subject Alternative Name	<p>This field displays the certificate owner's IP address (IP), domain name (DNS) or email address (EMAIL).</p>
Key Usage	<p>This field displays for what functions the certificate's key can be used. For example, "DigitalSignature" means that the key can be used to sign certificates and "KeyEncipherment" means that the key can be used to encrypt text.</p>
Extended Key Usage	<p>This field displays how the Zyxel Device generates and stores a request for server authentication, client authentication, or IKE Intermediate authentication certificate.</p>
Basic Constraint	<p>This field displays general information about the certificate. For example, Subject Type=CA means that this is a certification authority's certificate and "Path Length Constraint=1" means that there can only be one certification authority in the certificate's path. This field does not display for a certification request.</p>
PEM Encoded Format	<p>This read-only text box displays the certificate or certification request in Privacy Enhanced Mail (PEM) format. PEM uses lowercase letters, uppercase letters and numerals to convert a binary certificate into a printable form.</p> <p>You can copy and paste a certification request into a certification authority's web page, an email that you send to the certification authority or a text editor and save the file on a management computer for later manual enrollment.</p> <p>You can copy and paste a certificate into an email to send to friends or colleagues or you can copy and paste a certificate into a text editor and save the file on a management computer for later distribution (via external storage device for example).</p>
MD5 Fingerprint	<p>It is a unique 128-bit checksum value generated by the MD5 hashing algorithm, used to verify data integrity and identify cryptographic keys, though it is no longer considered secure.</p>
SHA1 Fingerprint	<p>It is a 160-bit hash value produced by the SHA-1 hashing algorithm, commonly used to verify data integrity and identify cryptographic keys, although it is now considered weak due to vulnerabilities.</p>
Apply	<p>Click Apply to save your changes back to the Zyxel Device.</p>
Cancel	<p>Click Cancel to return the screen to its last-saved settings.</p>

26.8.3 The My Certificates Import Screen

Click **System > Certificate > My Certificates > Import** to open the **Import Certificates** screen. Follow the instructions in this screen to save an existing certificate to the Zyxel Device.

Note: You can import a certificate that matches a corresponding certification request that was generated by the Zyxel Device. You can also import a certificate in PKCS#12 format, including the certificate's public and private keys.

The certificate you import replaces the corresponding request in the **My Certificates** screen.

You must remove any spaces from the certificate's filename before you can import it.

Figure 284 System > Certificate > My Certificates > Import

The following table describes the labels in this screen.

Table 229 System > Certificate > My Certificates > Import

LABEL	DESCRIPTION
File Path	Type in the location of the file you want to upload in this field or click Browse to find it. You cannot import a certificate with the same name as a certificate that is already in the Zyxel Device.
Browse	Click Browse to find the certificate file you want to upload.
Password	This field only applies when you import a binary PKCS#12 format file. Type the file's password that was created when the PKCS #12 file was exported.
OK	Click OK to save the certificate on the Zyxel Device.

26.9 Trusted Certificates

Click **System > Certificate > Trusted Certificates** to open the **Trusted Certificates** screen. This screen displays a summary list of certificates that you have set the Zyxel Device to accept as trusted. The Zyxel Device also accepts any valid certificate signed by a certificate on this list as being trustworthy; thus you do not need to import any certificate that is signed by one of these certificates.

Figure 285 System > Certificate > Trusted Certificates



The following table describes the labels in this screen.

Table 230 System > Certificate > Trusted Certificates

LABEL	DESCRIPTION
Edit	Double-click an entry or select it and click Edit to open a screen with an in-depth list of information about the certificate.
Remove	The Zyxel Device keeps all of your certificates unless you specifically delete them. Uploading a new firmware or default configuration file does not delete your certificates. To remove an entry, select it and click Remove . The Zyxel Device confirms you want to remove it before doing so. Subsequent certificates move up by one when you take this action.
Import	Click Import to open a screen where you can save the certificate of a certification authority that you trust, from your computer to the Zyxel Device.
Export	Click this and the following screen will appear. Type the selected certificate's password and save the selected certificate to your computer. Figure 286 Export a Certificate
Name	This field displays the name used to identify this certificate.
Subject	This field displays identifying information about the certificate's owner, such as CN (Common Name), OU (Organizational Unit or department), O (Organization or company) and C (Country). It is recommended that each certificate have unique subject information.
Issuer	This field displays identifying information about the certificate's issuing certification authority, such as a common name, organizational unit or department, organization or company and country. With self-signed certificates, this is the same information as in the Subject field.

Table 230 System > Certificate > Trusted Certificates (continued)

LABEL	DESCRIPTION
Valid From	This field displays the date that the certificate becomes applicable.
Valid To	This field displays the date that the certificate expires. The text displays in red and includes an Expired! message if the certificate has expired.

26.9.1 The Trusted Certificates Edit Screen

Click **System > Certificate > Trusted Certificates > Edit** icon to open the **Trusted Certificates Edit** screen. Use this screen to view in-depth information about the certificate.

Figure 287 System > Certificate > Trusted Certificates > Edit

Certificate Path

```

certificate path: 1
issuer: CN=USG_FLEX_200HP_D8EC655C0D04
subject: CN=USG_FLEX_200HP_D8EC655C0D04
validation result: self-signed

```

Refresh

Certificate Information

Name	default.crt
Type	Self-signed X.509 Certificate
Version	3
Serial Number	53:92:78:38:a9:51:93:ca:0a:99:3a:c5:ad...
Subject	CN = USG_FLEX_200HP_D8EC655C0D04
Issuer	CN = USG_FLEX_200HP_D8EC655C0D04
Signature Algorithm	sha256WithRSAEncryption
Valid From	Feb 15 08:22:20 2023 GMT
Valid To	Feb 12 08:22:20 2033 GMT
Key Algorithm	rsaEncryption
Subject Alternative Name	email:USG_FLEX_200HP_D8EC655C0D04
Key Usage	Digital Signature, Key Encipherment, D...
Extended Key Usage	
Basic Constraints	CA:TRUE, pathlen:1

Certificate in PEM (Base-64) Encoded Format

```

-----BEGIN CERTIFICATE-----
MIDRzCCA+gAwIBAgIUU5J4CKRk80KmtZPfx0aTd4JyowDQYJK
OZIwNwAqEL
BQAwwJEMCIGA1UEAwVbVFNHX0ZMRVhmfjAwwSFRhFQ0U1
NUMWRDA0MB4XDzIz
MDIxNTA4MjYyMjYwXDTMzMDIxMjA4MjYyMjYwJEMCIGA1UEAw

```

The following table describes the labels in this screen.

Table 231 System > Certificate > Trusted Certificates > Edit

LABEL	DESCRIPTION
Certification Path	Click the Refresh button to have this read-only text box display the end entity's certificate and a list of certification authority certificates that shows the hierarchy of certification authorities that validate the end entity's certificate. If the issuing certification authority is one that you have imported as a trusted certificate, it may be the only certification authority in the list (along with the end entity's own certificate). The Zyxel Device does not trust the end entity's certificate and displays "Not trusted" in this field if any certificate on the path has expired or been revoked.
Refresh	Click Refresh to display the certification path.
Name	This field displays the identifying name of this certificate.
Type	This field displays general information about the certificate. CA-signed means that a Certification Authority signed the certificate. Self-signed means that the certificate's owner signed the certificate (not a certification authority). X.509 means that this certificate was created and signed according to the ITU-T X.509 recommendation that defines the formats for public-key certificates.
Version	This field displays the X.509 version number.
Serial Number	This field displays the certificate's identification number given by the certification authority.
Subject	This field displays information that identifies the owner of the certificate, such as Common Name (CN), Organizational Unit (OU), Organization (O) and Country (C).
Issuer	This field displays identifying information about the certificate's issuing certification authority, such as Common Name, Organizational Unit, Organization and Country. With self-signed certificates, this is the same information as in the Subject Name field.
Signature Algorithm	This field displays the type of algorithm that was used to sign the certificate. Some certification authorities use rsa-pkcs1-sha1 (RSA public-private key encryption algorithm and the SHA1 hash algorithm). Other certification authorities may use rsa-pkcs1-md5 (RSA public-private key encryption algorithm and the MD5 hash algorithm).
Valid From	This field displays the date that the certificate becomes applicable. The text displays in red and includes a Not Yet Valid! message if the certificate has not yet become applicable.
Valid To	This field displays the date that the certificate expires. The text displays in red and includes an Expiring! or Expired! message if the certificate is about to expire or has already expired.
Key Algorithm	This field displays the type of algorithm that was used to generate the certificate's key pair (the Zyxel Device uses RSA encryption) and the length of the key set in bits (1024 bits for example).
Subject Alternative Name	This field displays the certificate's owner's IP address (IP), domain name (DNS) or email address (EMAIL).
Key Usage	This field displays for what functions the certificate's key can be used. For example, "DigitalSignature" means that the key can be used to sign certificates and "KeyEncipherment" means that the key can be used to encrypt text.
Extended Key Usage	This field displays the method that the Zyxel Device generates and stores a request for server authentication, client authentication, or IKE Intermediate authentication certificate.
Basic Constraint	This field displays general information about the certificate. For example, Subject Type=CA means that this is a certification authority's certificate and "Path Length Constraint=1" means that there can only be one certification authority in the certificate's path.
MD5 Fingerprint	It is a unique 128-bit checksum value generated by the MD5 hashing algorithm, used to verify data integrity and identify cryptographic keys, though it is no longer considered secure.

Table 231 System > Certificate > Trusted Certificates > Edit (continued)

LABEL	DESCRIPTION
SHA1 Fingerprint	It is a 160-bit hash value produced by the SHA-1 hashing algorithm, commonly used to verify data integrity and identify cryptographic keys, although it is now considered weak due to vulnerabilities.
Certificate in PEM (Base-64) Encoded Format	<p>This read-only text box displays the certificate or certification request in Privacy Enhanced Mail (PEM) format. PEM uses lowercase letters, uppercase letters and numerals to convert a binary certificate into a printable form.</p> <p>You can copy and paste the certificate into an email to send to friends or colleagues or you can copy and paste the certificate into a text editor and save the file on a management computer for later distribution (via external storage device for example).</p>

26.9.2 The Trusted Certificates Import Screen

Click **System > Certificate > Trusted Certificates > Import** to open the **Import Trusted Certificates** screen. Follow the instructions in this screen to save a trusted certificate to the Zyxel Device.

Note: You must remove any spaces from the certificate's filename before you can import the certificate.

Figure 288 System > Certificate > Trusted Certificates > Import

The following table describes the labels in this screen.

Table 232 System > Certificate > Trusted Certificates > Import

LABEL	DESCRIPTION
File Path	Type in the location of the file you want to upload in this field or click Browse to find it. You cannot import a certificate with the same name as a certificate that is already in the Zyxel Device.
Browse	Click Browse to find the certificate file you want to upload.
OK	Click OK to save the certificate on the Zyxel Device.

26.10 Advanced

Click **System > Advanced** to open the **Advanced** screen. Use this screen to view UDP and ICMP timeout settings on your Zyxel Device and to enable or disable ARP spoofing prevention, device insight, and LLDP functions.

Figure 289 System > Advanced

System Parameters			
Name ↕	Description ↕	Value ↕	
UDP Timeout (secon...	The timeout for initial UDP packets in a connection. (seconds)	300 (se...	
UDP Timeout Strea...	The timeout values of the UDP streams once they have sent enough packets...	60 (sec...	
ICMP Timeout (seco...	The timeout for ICMP connection. (seconds)	5 (seco...	
Additional Features			
Enabled	Name ↕	Description ↕	Setting ↕
<input checked="" type="checkbox"/>	ARP Spoofing Prevention	Prevents unauthorized devices from sending fake Address Resolution Protocol (ARP) messages, enhancing network security.	
<input checked="" type="checkbox"/>	Category Query Fail-open	Bypass category check for DNS/URL Threat Filter, Content Filter when category server is unreachable.	
<input type="checkbox"/>	Device Insight	Gain detailed understanding and analysis of network devices, providing valuable information on their activities and characteristics.	
<input checked="" type="checkbox"/>	Drop Invalid TCP Flags Pkt	Drop TCP packets with invalid flags.	
<input type="checkbox"/>	Drop SYN with Payload Pkt	Drop TCP SYN packets with payloads.	
<input type="checkbox"/>	LLDP Beta	Allows devices to discover and share information about connected neighbors in a local network.	

The following table describes the labels in this screen.

Table 233 System > Advanced

LABEL	DESCRIPTION
System Parameters	
Name	This field displays the name of the system parameter. UDP Timeout: After the UDP client sends a request to the server, if there is no response from the server within this set time, the Zyxel Device ends the UDP connection. UDP Timeout Stream: The UDP client sends a request to the server and receives a response, but the connection is interrupted. If there is no further response from the server within this set time, the Zyxel Device ends the UDP connection ICMP Timeout: This shows how long the Zyxel Device waits before considering the ICMP connection attempt a failure.
Description	This field displays the description of the system information.
Value	This field displays the value of the system information. Click the Edit icon to modify the value.
Additional Features	

Table 233 System > Advanced (continued)

LABEL	DESCRIPTION
Enabled	Click this switch to enable or disable the feature. When the switch turns green, the function is enabled.
Name	This field displays the name of the following features.
ARP Spoofing Prevention	Enable this feature to prevent and create a log on the Zyxel Device when there is a fake ARP message that failed the ARP verification.
Category Query Fail-open	<p>A category server classifies IP addresses and URLs to different categories, such as anonymizers, browser exploits, and malicious downloads. Enable this feature to allow traffic to bypass if the Zyxel Device cannot access the category server. Click on the Edit icon next to this field to configure more settings.</p> <p>Use Log to generate a log (log) or not (no) when the query to the category server failed.</p>
Device Insight	Enable this feature to collect status and basic information of the clients connected to the Zyxel Device.
Drop Invalid TCP Flags Pkt	<p>Enable this feature to allow the Zyxel Device to inspect TCP packets and drop any with invalid flags, such as FIN + SYN, FIN + RST, and SYN + RST flag combinations. Click on the Edit icon next to this field to configure more settings.</p> <p>Use Log to generate a log (log), log and alert (log alert) or not (no) when the Zyxel Device detects an invalid TCP flag.</p>
Drop SYN with Payload Pkt	<p>When setting up a TCP connection, a SYN packet is used during the initial handshake to establish connection between two network devices, and typically does not carry any data payload. A SYN packet with a payload may indicate a potential attack, such as a SYN flood. Enable this feature to allow your Zyxel Device to drop SYN packets with a payload. Click on the Edit icon next to this field to configure more settings.</p> <p>Log: Generate a log (log), log and alert (log alert) or not (no) when there is a SYN packet with payload detected by the Zyxel Device.</p> <p>Destination Port: Specify a destination port number to drop SYN packets with a payload sent to that port. If set to 0, SYN packets with a payload sent to any port will be dropped.</p> <p>Payload Size (greater than or equal to): Specify the size (in bytes) to drop SYN packets with a payload of this size or larger.</p>
LLDP	Link Layer Discovery Protocol (LLDP, IEEE 802.1AB) is a Layer 2 protocol that allows network devices to advertise their identity and capabilities on a LAN. Enable this feature to allow your Zyxel Device to share its identity and capabilities on the local network.
Description	This field displays what the feature does.

CHAPTER 27

Log and Report

27.1 Overview

Use these screens to configure daily reporting and log settings.

27.1.1 What You Can Do In this Chapter

- Use the **Log/Events** screen ([Section 27.2 on page 470](#)) to view the Zyxel Device log messages.
- Use the **Log Settings** screen ([Section 27.3 on page 474](#)) to specify settings for recording log messages and alerts and storing them on a connected USB storage device.
- Use the **SecuReporter** screen ([Section 27.4 on page 477](#)) to enable SecuReporter logging on your Zyxel Device, see license status, type, expiration date and access a link to the SecuReporter web portal. The SecuReporter web portal collects and analyzes logs from your Zyxel Device in order to identify anomalies, alert on potential internal/ external threats, and report on network usage.
- Use the **Email Daily Report** screen ([Section 27.5 on page 479](#)) to start or stop traffic collection and view reports on traffic passing through the Zyxel Device.

27.2 Log/Events Screen

To access this screen, click **Log & Report > Log/Events**. The log is displayed on the following screen.

Note: When a log reaches the maximum number of log messages, new log messages automatically overwrite existing log messages, starting with the oldest existing log message first.

- The maximum possible number of log messages in the Zyxel Device varies by model.

Events that generate an alert (as well as a log message) display in red. Regular logs display in black. Click a column's heading cell to sort the table entries by that column's criteria. Click the heading cell again to reverse the sort order. The Web Configurator saves the filter settings if you leave the **Log/Events** screen and return to it later.

Figure 290 Log & Report > Log/Events

#	Time	Pri.	Category	Message	Src. IP	Src. Port	Dst. IP	Dst. Port	Note
1	2024-03-06 14:02:11	notice	User	Administrator John(MAC=) from http/https has logged in Device	172.21.48.84	0	0.0.0.0	0	Acco
2	2024-03-06 13:59:10	notice	User	Administrator John from http/https has logged out Device	172.21.48.84	0	0.0.0.0	0	Acco
3	2024-03-06 13:57:41	notice	User	Administrator John(MAC=) from http/https has logged in Device	172.21.48.84	0	0.0.0.0	0	Acco
4	2024-03-06 13:57:31	notice	User	Administrator John from http/https has logged out Device	172.21.48.84	0	0.0.0.0	0	Acco
5	2024-03-06 13:38:48	notice	User	Administrator admin(MAC=) from http/https has logged in Device	172.21.56.18	0	0.0.0.0	0	Acco
6	2024-03-06 12:08:51	notice	User	Administrator admin from http/https has logged out Device	172.21.56.18	0	0.0.0.0	0	Acco
7	2024-03-06 10:31:25	notice	User	Administrator admin(MAC=) from http/https has logged in Device	172.21.56.18	0	0.0.0.0	0	Acco
8	2024-03-06 09:56:50	error	Cloud Helper	ZSDN auth fail for cloud_query.	0.0.0.0	0	0.0.0.0	0	
9	2024-03-06 09:56:49	error	Cloud Helper	An exception occurred while trying to connect with server.	0.0.0.0	0	0.0.0.0	0	
10	2024-03-06 08:56:29	error	Cloud Helper	ZSDN auth fail for sandbox.	0.0.0.0	0	0.0.0.0	0	
11	2024-03-06 08:56:28	error	Cloud Helper	An exception occurred while trying to connect with server.	0.0.0.0	0	0.0.0.0	0	
12	2024-03-06 08:56:22	error	Cloud Helper	ZSDN auth fail for fetch_url.	0.0.0.0	0	0.0.0.0	0	
13	2024-03-06 08:56:21	error	Cloud Helper	An exception occurred while trying to connect with server.	0.0.0.0	0	0.0.0.0	0	
14	2024-03-06 08:34:04	error	myZyXEL.com	System protection signature download has failed.	0.0.0.0	0	0.0.0.0	0	
15	2024-03-06 06:24:01	notice	SSL Inspection	SSL Certificate version 1.1.079 on device is latest.	0.0.0.0	0	0.0.0.0	0	
16	2024-03-06 03:58:01	notice	IP Reputation	No license to do signature update.	0.0.0.0	0	0.0.0.0	0	
17	2024-03-06 00:00:01	info	Traffic Statistics	Traffic statistics daily cleanup.	0.0.0.0	0	0.0.0.0	0	
18	2024-03-05 21:56:47	error	Cloud Helper	ZSDN auth fail for cloud_query.	0.0.0.0	0	0.0.0.0	0	
19	2024-03-05 21:56:46	error	Cloud Helper	An exception occurred while trying to connect with server.	0.0.0.0	0	0.0.0.0	0	
20	2024-03-05 20:56:26	error	Cloud Helper	ZSDN auth fail for sandbox.	0.0.0.0	0	0.0.0.0	0	
21	2024-03-05 20:56:25	error	Cloud Helper	An exception occurred while trying to connect with server.	0.0.0.0	0	0.0.0.0	0	
22	2024-03-05 20:56:19	error	Cloud Helper	ZSDN auth fail for fetch_url.	0.0.0.0	0	0.0.0.0	0	

The following table describes the labels in this screen.

Table 234 Log & Report > Log/Events

LABEL	DESCRIPTION
Category	Select the type of log you want to display from this list box. 
Filter	Click the this button then click + to display the add filter, pick a filter, then click Search to display specific sessions according to the filter selected. You may select multiple filters, but just one of each type, configured one at a time.
Source Address	This displays when you show the filter. Type the source IP address of the incoming packet that generated the log message. Do not include the port in this filter.

Table 234 Log & Report > Log/Events (continued)

LABEL	DESCRIPTION
Destination Address	This displays when you show the filter. Type the IP address of the destination of the incoming packet when the log message was generated. Do not include the port in this filter.
Source Interface	This displays when you show the filter. Type the source interface of the incoming packet that generated the log message.
Destination Interface	This displays when you show the filter. Type the interface of the destination of the incoming packet when the log message was generated.
Protocol	This displays when you show the filter. Select a service protocol whose log messages you would like to see.
Clear Log	Click this button to clear the whole log, regardless of what is currently displayed on the screen.
Export	Click this button to download logs of the chosen category to your computer in Excel (format (.xlsx)).
Refresh	Click this button to update the information on the screen.
SecuReporter	<p>The following category of logs show a SecuReporter icon . Click this icon to view more historical logs in SecuReporter. You should already have a SecuReporter account.</p> <ul style="list-style-type: none"> • Anti-Malware • Application Patrol • Content Filter • DNS Threat Filter • IP Reputation • IPS • Sandbox • URL Threat Filter
Search	<p>Type a keyword to look for in the Message, Source, Destination and Note fields. If a match is found in any field, the log message is displayed. You can use up to 63 alphanumeric characters and the underscore, as well as punctuation marks () ' , ; ? ! + - * / = # \$ % @ ; the period, double quotes, and brackets are not allowed.</p> 
Filter	<p>Click this icon to display specific types of logs. Select a type or type a keyword depending on the filter chosen.</p> 

Table 234 Log & Report > Log/Events (continued)

LABEL	DESCRIPTION
#	This field is a sequential value, and it is not associated with a specific log message.
Time	This field displays the time the log message was recorded.
Pri	This displays when you show the filter. Select the priority of log messages to display. The log displays the log messages with this priority or higher. Choices are: emerg , alert , crit , error , warn , notice , and info , from highest priority to lowest priority.
Category	This field displays the log that generated the log message. It is the same value used in the Category field above.
Message	This field displays the reason the log message was generated. The text "[count=x]", where <i>x</i> is a number, appears at the end of the Message field if log consolidation is turned on and multiple entries were aggregated to generate into this one.
Src. IP	This field displays the source IP address in the event that generated the log message.
Src. Port	This field displays the source port number in the event that generated the log message.
Dst. IP	This field displays the destination IP address of the event that generated the log message.
Dst. Port	This field displays the destination port number of the event that generated the log message.
Note	This field displays any additional information about the log message.
Action	This field displays whether packets were dropped, blocked or if no action was taken as a result of the log. It should correspond to the action configured in Security Policy > Policy Control .

27.2.1 Log Details

Double-click a log entry to display details on the log. The below is an example.

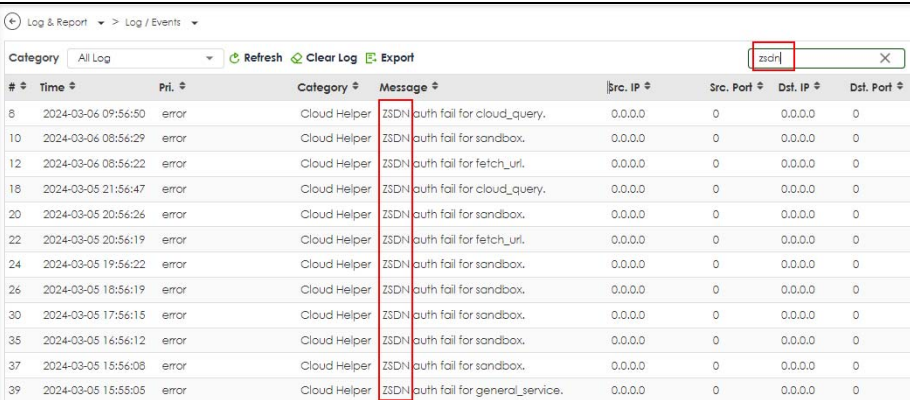
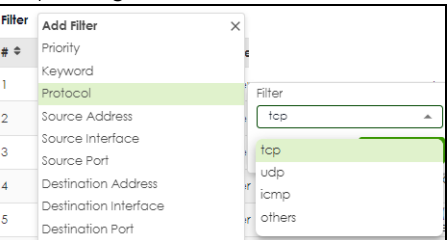
Log Details	
General	▼
Message	▼
Identification	▲
Source	172.21.48.84
Source Interface	
Destination	0.0.0.0
Destination Interface	
Protocol	
Extended Information	▲
devID	d8ece56094fe
src	172.21.48.84
dvchost	usgflex500h
msg	Administrator John(MA C:-) from http/https has logged in Device
cat	User
ZYlevel	notice
ZYnote	Account: John
suser	John
spriv	Administrator
ZYauthType	http/https

27.3 Log Settings Screen

The **Log Settings** screen control log messages. A log message stores the information for viewing or regular emailing later.

The Zyxel Device provides a system log and supports email profiles and remote syslog servers. Use the email profiles to mail log messages to the specific destinations. You can also have the Zyxel Device store system logs on a connected USB storage device. The other two logs are stored on specified syslog servers.

Note: Only connect one USB device. It must allow writing (it cannot be read-only) and use the FAT16, FAT32, EXT2, or EXT3 file system.

To access this screen, click **Log & Report > Log Settings**.

Figure 291 Log & Report > Log Settings

←
Log & Report
▼
>
Log Setting
▼

Log Category Setting ▲

Category	System Log			USB Storage			Remote Server 1			Remote Server 2			Count
	Disable	Normal	Debug	Disable	Normal	Debug	Disable	Normal	Debug	Disable	Normal	Debug	
Search Category <input style="width: 80px;" type="text"/>	⊖	⊖	⊖	⊕	○	○	⊕	○	○	⊕	○	○	9248
> Authenticate	⊖	⊖	○	⊕	○	○	⊕	○	○	⊕	○	○	18
> Security	○	⊕	○	⊕	○	○	⊕	○	○	⊕	○	○	9086
> System	⊖	⊖	⊖	⊕	○	○	⊕	○	○	⊕	○	○	141
> Security Services	⊖	⊖	○	⊕	○	○	⊕	○	○	⊕	○	○	2
> VPN	○	⊕	○	⊕	○	○	⊕	○	○	⊕	○	○	1
> License	⊖	⊖	○	⊕	○	○	⊕	○	○	⊕	○	○	0
> Network	⊖	⊖	○	⊕	○	○	⊕	○	○	⊕	○	○	0

System Log

Log Consolidation

Consolidation Interval (10 Seconds - 600 Seconds)

USB Storage

Enable USB storage

Enable Log Rotation by File Size

Rotate Based On File Size MB

File Size Check Interval Minute(s)

Enable Compression

Log Keep Duration

Keep Duration Day(s)

USB Disk Full Warning

Threshold (Remaining Space) MB

Purge old file when reached threshold

Remote Syslog Server

Remote Server 1

Remote Server 2

Active

Log Format

Server Address (Server Name or IP Address)

Server Port

Log Facility

Some changes were made

What do you want to do then?

Cancel
Apply

The following table describes the labels in this screen.

Table 235 Log & Report > Log Settings

LABEL	DESCRIPTION
Log Category Setting	Select which events you want to log by Category . There are three choices: Disable - do not log any information from this category Normal - create log messages and alerts from this category Debug - create log messages, alerts, and debugging information from this category; the Zyxel Device does not email debugging information, however, even if this setting is selected.
Log Consolidation	Enable this to activate log consolidation. Log consolidation aggregates multiple log messages that arrive within the specified Consolidation Interval . In Log Category Setting , the Count field is the number of original log messages when multiple log messages were aggregated.
Consolidation Interval	Type how often, in seconds, to consolidate log information. If the same log message appears multiple times, it is aggregated into one log message in the Count field in Log Category Setting .
Enable USB Storage	Enable this if you want to use a connected USB device. The USB log file is saved as YYYY-MM-DD.log where YYYY-MM-DD is the current system date. The Zyxel Device supports USB file systems FAT16, FAT32, EXT3, and EXT4. Note: You can remove a USB stick and replace it with a new one for new logs while the Zyxel Device is on.
Enable Log Rotation by File Size	Use this to maximize the size of a file containing logs on the USB stick. Any number of files, each up to the maximum size, can be saved to the USB stick daily. 'Rotated' log files, for example, 2025-01-03.log.1, 2025-01-03.log.2. etc., are also saved to the USB stick.
Rotate Based On File Size	Set the maximum size of a file containing logs on the USB stick. For example, if you set this to 100MB, and the 2025-01-03.log file exceeds 100MB, then the contents of 2025-01-03.log is moved to 2025-01-03.log.1, so that logs can be added to 2025-01-03.log again. If the 2025-01-03.log.1 already exists, then 2025-01-03.log.1 is renamed to 2025-01-03.log.2, and its content is then moved from 2025-01-03.log to 2025-01-03.log.1.
File Size Check Interval	Set how often to check log file sizes on the USB stick. The range is from 1 to 360 minutes. The default is 5 minutes.
Enable Compression	Enable this to gzip log files to reduce size. You will be able to save more log files to the USB stick, but you will have to have to unzip them first to perform analysis of the logs. 'Rotated' compressed log files, for example, 2025-01-03.log.1.gz, 2025-01-03.log.2.gz etc., are also saved on the USB stick.
Log Keep Duration	Set a number of days (1 to 365) that the Zyxel Device keeps a log file on the USB stick. When a log file exceeds the number of days set here, the file is deleted from the USB stick. When the USB stick is full, new logs are not sent to the USB stick until files are removed from there.
USB Disk Full Warning	Enable this to create a log when the available space on the USB stick connected to the Zyxel Device is below the specified threshold.
Threshold (Remaining Space)	Set the minimum size needed to save logs on the connected USB stick (100 to 9999) in MB. When the available space on the USB stick is below this value, a log will be created. The default value is 200 MB.
Purge old file when reached threshold	If the available space on the USB stick is below the specified threshold, the oldest log files will be removed until the available space is above the threshold. Then, the new logs can be saved to the USB stick.
Remote Server 1/2	
Active	Enable this to send log information according to the information in this section.
Log Format	This field displays the format of the log information. It is read-only. Syslog - syslog compatible format. CEF/Syslog - Common Event Format, syslog-compatible format.

Table 235 Log & Report > Log Settings (continued)

LABEL	DESCRIPTION
Server Address	Type the server name or the IP address of the syslog server to which to send log information.
Server Port	Type the service port number used by the remote server.
Log Facility	Select a log facility. The log facility allows you to log the messages to different files in the syslog server. Please see the documentation for your syslog program for more information.
Apply	Click Apply to save your changes back to the Zyxel Device.
Cancel	Click Cancel to return the screen to its last-saved settings.

27.4 SecuReporter

SecuReporter is a security analytics portal that collects and analyzes logs from SecuReporter-licensed Zyxel Devices in order to identify anomalies, alert on potential internal / external threats, and report on network usage. You need to buy a license for SecuReporter for your Zyxel Device and register it at NCC.

If a license has expired, you will see a reminder in this screen. You need to renew the license in order to keep using the feature. Click **Buy Now** to go to Marketplace to purchase a new license. Click **See Details** to go to the Zyxel web page to find more information on licenses for your Zyxel Device.

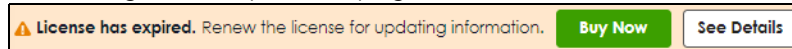
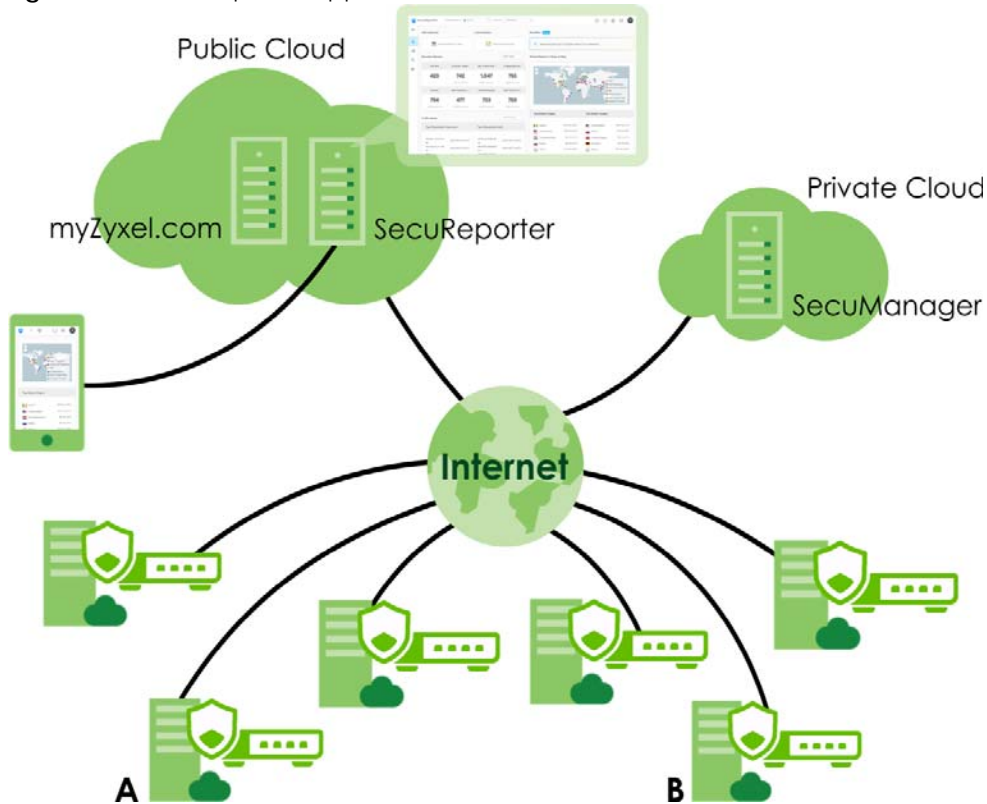

Figure 292 SecuReporter Application Scenario



How to activate and enable SecuReporter

- 1 If SecuReporter **Service Status** does not display **Activated**, you have to log in to NCC and activate the SecuReporter license for this Zyxel Device. The Zyxel Device must be able to communicate with the NCC server.
- 2 After the SecuReporter license is activated, go back to the **Log & Report > SecuReporter** screen, and select the categories of logs that you want this Zyxel Device to send to the SecuReporter portal.
- 3 Slide the switch to the right under **General Settings** to enabled SecuReporter. Do not go to the SecuReporter portal until after you have enabled SecuReporter on this Zyxel Device and applied the settings. You can also see license status, type, expiration date.
- 4 Click **Apply** and wait.

How to add this Zyxel Device to SecuReporter

- 1 Log in to the SecuReporter portal.
- 2 Go to **More > Organization & Devices**, click **Add Organization** to create an organization.
- 3 Add this Zyxel Device to the organization you created using the hyper link under **Unclaimed**.

Click **Log & Report > SecuReporter** to open the following screen.

Figure 293 Log & Report > SecuReporter

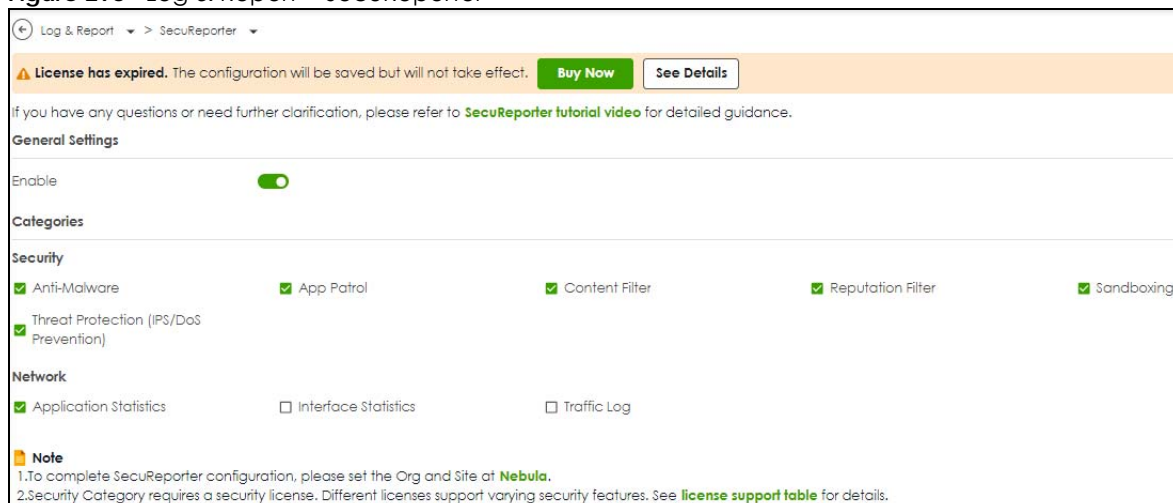

The following table describes the labels in this screen.

Table 236 Log & Report > SecuReporter

LABEL	DESCRIPTION
Enable	This must be enabled to have SecuReporter collect and analyze logs from this Zyxel Device. Click SecuReporter tutorial video to go to YouTube to see related configuration videos. It's selected by default if you have activated a SecuReporter license.
Categories	Select the categories of logs that you want this Zyxel Device to send to SecuReporter for analysis and trend spotting. You need an active license for the Security categories.

Table 236 Log & Report > SecuReporter (continued)

LABEL	DESCRIPTION
Apply	Click Apply to save your changes back to the Zyxel Device.
Cancel	Click Cancel to return the screen to its last-saved settings.

27.5 Email Daily Report

Use the **Email Daily Report** screen to start or stop data collection and view various statistics about traffic passing through your Zyxel Device. Click the **Mail Server** link under **Note** to set up the mail server in the **Notification** screen.

Note: Data collection may decrease the Zyxel Device's traffic throughput rate.

Click **Log & Report > Email Daily Report** to display the following screen. Configure this screen to have the Zyxel Device email you system statistics at the specified time.

Figure 294 Log & Report > Email Daily Report

The following table describes the labels in this screen.

Table 237 Log & Report > Email Daily Report

LABEL	DESCRIPTION
Enable Email Daily Report	Select this to send reports by email every day.
Reset All Counters	Click this to discard all report data and start all of the counters over at zero.
E-mail Subject	Type the subject line for outgoing email from the Zyxel Device. Type a string using up to 60 of these characters [a-zA-Z0-9'()+,./:=?;!#@\$_%-].
E-mail From	Type the email address from which the outgoing email is sent.
E-mail To	Type the email address (or addresses) to which the outgoing email is delivered.
Send Report Now	Click this button to have the Zyxel Device send the daily email report immediately. Check your spam mail folder if you cannot receive the report.
Reset counters after sending report successfully	Select Reset counters after sending report successfully if you only want to see statistics for a 24 hour period.

Table 237 Log & Report > Email Daily Report (continued)

LABEL	DESCRIPTION
Report Items	Select the information to include in the report. Types of information include System Resource Usage, Traffic Statistics, Security Services and System Information .
Schedule	Select the time of the day the report is emailed.
Apply	Click Apply to save your changes back to the Zyxel Device.
Cancel	Click Cancel to return the screen to its last-saved settings.

27.5.1 Example Reports

The following screens are an example of a email daily report.

Figure 295 Email Daily Report: System Resource Usage

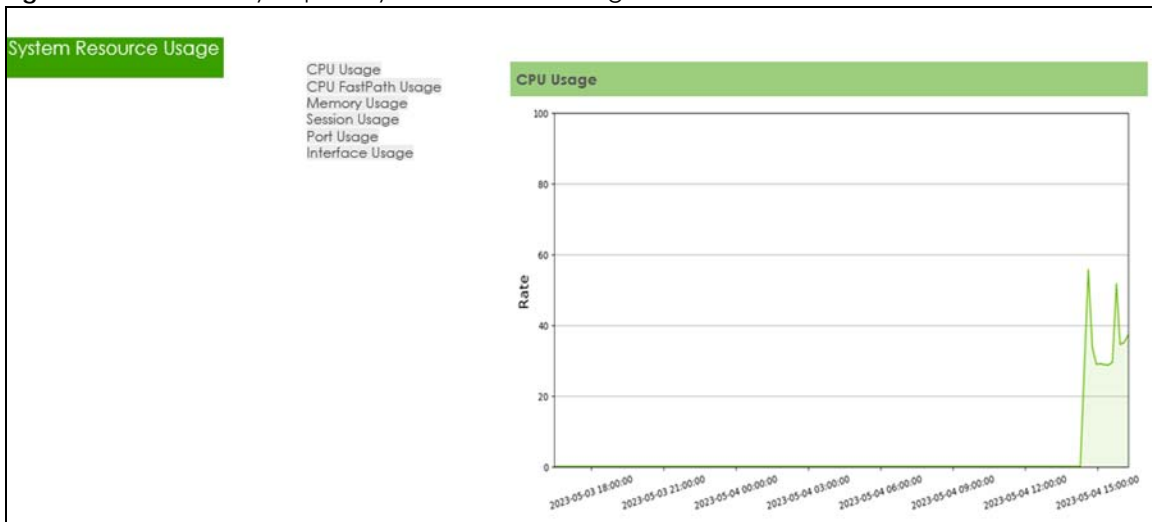

Figure 296 Email Daily Report- Licensing

The screenshot displays the 'Licensing' report. It contains two tables. The first table, 'License Status', lists various services and their activation status. The second table, 'Signature Status', lists signatures, their versions, and release dates.

Service Name	Status	Service Type
Reputation Filter	Activated	standard
Application Patrol	Activated	standard
Web Filtering	Activated	standard
AntiMalware	Activated	standard
SecuReporter	Activated	standard
PS	Activated	standard

Signature	Version	Release Date
PS	4.0.1.20230411.0	2023-04-11 10:10:00
App Patrol	2.0.0.20230427.0	2023-04-27 09:44:59
P Reputation	1.0.0.20230428.0	2023-04-29 02:31:46

Figure 297 Email Daily Report: Threat Report

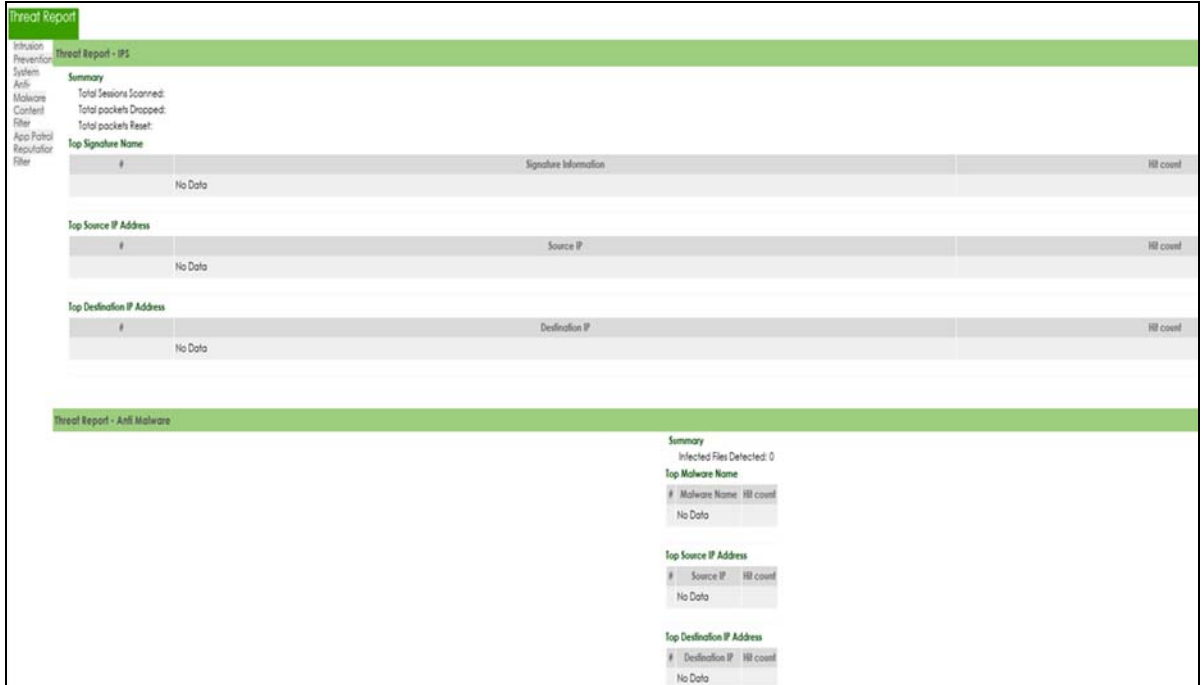
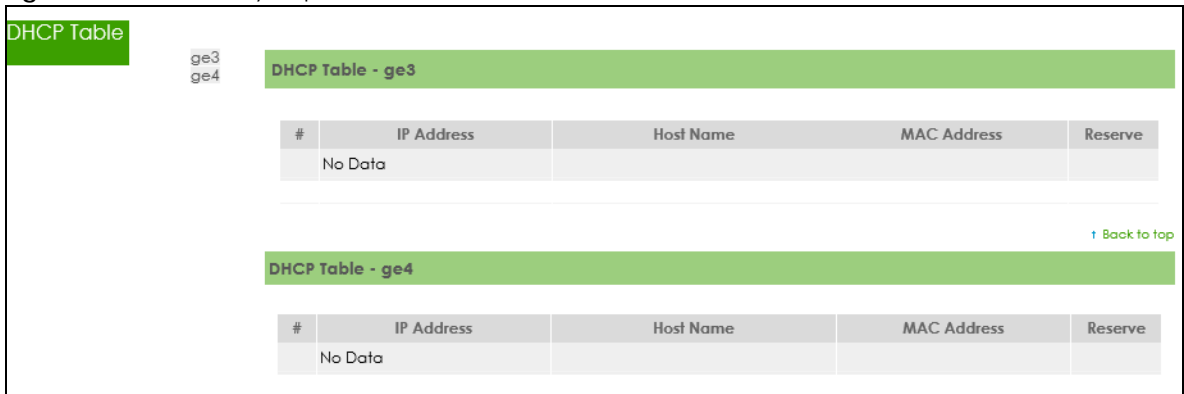

Figure 298 Email Daily Report: DHCP Table



CHAPTER 28

Firmware/File Manager

28.1 Overview

Configuration files define the Zyxel Device's settings. You can apply a configuration file without the Zyxel Device restarting. You can store multiple configuration files on the Zyxel Device. You can edit configuration files in a text editor and upload them to the Zyxel Device. Configuration files use a .conf extension.

28.1.1 What You Can Do in this Chapter

- Use the **Configuration File** screen (see [Section 28.2 on page 484](#)) to store and name configuration files. You can also download configuration files from the Zyxel Device to your computer and upload configuration files from your computer to the Zyxel Device.
- Use the **Firmware Package** screen (see [Section 28.3 on page 492](#)) to check your current firmware version and upload firmware to the Zyxel Device.

28.1.2 What you Need to Know

Configuration Files

When you apply a configuration file, the Zyxel Device uses the factory default settings for any features that the configuration file does not include. Other settings do not change.

The Zyxel Device applies configuration files in the following way:

- Reset to default configuration.
- Go into CLI **Configuration** mode.
- Run the commands in the configuration file.

28.1.3 Configuration File Flow at Restart

You can manually restart the Zyxel Device through a management interface or by physically turning the power off and back on.

The Zyxel Device restarts automatically when you upload new firmware.

The Zyxel Device always checks for errors in any configuration file when rebooting. The Zyxel Device generates a log for any errors.

- If there is not a **startup-config.conf** when you restart the Zyxel Device, the Zyxel Device uses the **system-default.conf** configuration file with the Zyxel Device's default settings. The Zyxel Device will apply the **system-default.conf** when it boots without a **startup-config.conf**, even if you have a **lastgood.conf**.

- If there is a **startup-config.conf**, the Zyxel Device checks it for errors and applies it if there are no errors. The Zyxel Device also copies it to the **lastgood.conf** configuration file as a back up file.
- If there is an error in **startup-config.conf**, the Zyxel Device generates a log and copies **startup-config.conf** to **startup-config-bad.conf** and then tries the existing **lastgood.conf** configuration file.
- If there isn't a **lastgood.conf** configuration file or it also has an error, the Zyxel Device applies the **system-default.conf** configuration file.

Figure 299 Zyxel Device Start-up Flow

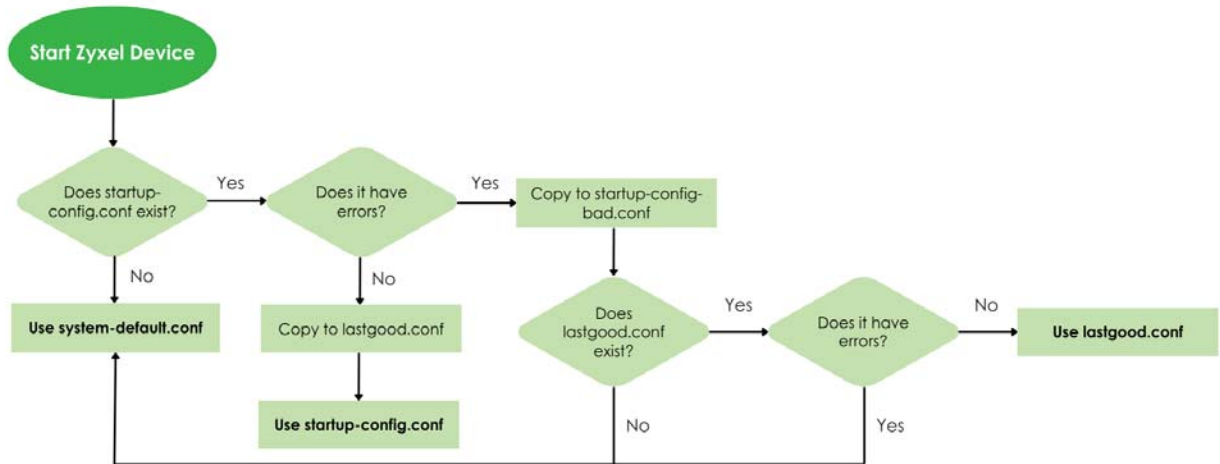

28.2 The Configuration File Screen

Click **Maintenance > Firmware/File Manager > Configuration File** to open the **Configuration File** screen.

Use the **Configuration** screen to store, run, and name configuration files. You can also download configuration files from the Zyxel Device to your computer and upload configuration files from your computer to the Zyxel Device.

Once your Zyxel Device is configured and functioning properly, it is highly recommended that you back up your configuration file before making further configuration changes. The backup configuration file will be useful in case you need to return to your previous settings.

Figure 300 Maintenance > Firmware/File Manager > Configuration File

Maintenance > Firmware/File Manager > Configuration File

Configuration File Firmware Management

Configuration

Rename Remove Download Copy Apply Email Upload Test

Search insights

File Name	Size	Last
<input type="checkbox"/> backup-2024-09-26-05-34-01.conf	92037	2024
<input type="checkbox"/> flex500h-20230306.conf	62823	2024
<input type="checkbox"/> lastgood.conf	54507	2024
<input type="checkbox"/> old-startup-config.conf	115139	2024
<input type="checkbox"/> startup-config-back.conf	54006	2024
<input checked="" type="checkbox"/> startup-config-backup-2023-03-20-07-00-01.conf	61673	2024
<input type="checkbox"/> startup-config-backup-2023-03-21-07-00-01.conf	61673	2024
<input type="checkbox"/> startup-config-backup-2023-03-22-07-00-01.conf	61673	2024
<input type="checkbox"/> startup-config.conf	61081	2024
<input type="checkbox"/> system-default.conf	53141	2024

Configure Backup Schedule

Enable Auto Backup

Daily (Hour) (Minute)
 Weekly (Day) (Hour) (Minute)
 Monthly (Day) (Hour) (Minute)

Send Email

Encryption Password

Email Subject Configuration File Backup Notification

Recipients (Email Address)
 It cannot exceed 83 characters. The valid characters are [a-z][A-Z][/=?^_{}~w-!#\$%*+].
 + Add

Email Content

Recovery Manager

Status Done Backup

File Name usgflex500h_RMABackup_2024-12-18.zip

Backup Date/Time 2024-12-18 09:50:38

File Size 106.10 KB Download Restore

Some changes were made
 What do you want to do then?
 Cancel Apply

Do not turn off the Zyxel Device while configuration file upload is in progress.

The following table describes the labels in this screen.

Table 238 Maintenance > Firmware/File Manager > Configuration File

LABEL	DESCRIPTION
Configuration	
Rename	<p>Use this button to change the label of a configuration file on the Zyxel Device. You can only rename manually saved configuration files. You cannot rename the lastgood.conf, system-default.conf and startup-config.conf files.</p> <p>You cannot rename a configuration file to the name of another configuration file in the Zyxel Device.</p> <p>Click a configuration file's row to select it and click Rename to open the Rename File screen.</p> <p>Specify the new name for the configuration file. Use up to 63 characters (including a-zA-Z0-9;~!@#\$\$%^&()+[]{}',.-=).</p> <p>Click OK to save the renamed label or click (X) to close the screen without saving the renamed label.</p>
Remove	<p>Click a configuration file's row to select it and click Remove to delete it from the Zyxel Device. You can only delete manually saved configuration files. You cannot delete the system-default.conf, startup-config.conf and lastgood.conf files.</p> <p>A pop-up window asks you to confirm that you want to delete the configuration file. Click OK to delete the configuration file or click Close to close the screen without deleting the configuration file.</p>
Download	<p>Click a configuration file's row to select it and click Download to save the configuration into your computer.</p>
Copy	<p>Use this button to save a duplicate of a configuration file on the Zyxel Device.</p> <p>Click a configuration file's row to select it and click Copy to open the Copy File screen.</p> <p>Specify a name for the duplicate configuration file. Use up to 63 characters (including a-zA-Z0-9;~!@#\$\$%^&()+[]{}',.-=).</p> <p>Click OK to save the duplicate or click (X) to close the screen without saving a duplicate of the configuration file.</p>
Apply	<p>Use this button to have the Zyxel Device use a specific configuration file.</p> <p>Click a configuration file's row to select it and click Apply to have the Zyxel Device use that configuration file. The following screen displays. Click OK to have the Zyxel Device start applying the configuration file or click Cancel to close the screen.</p> <div data-bbox="513 1352 1055 1596" style="border: 1px solid black; padding: 10px; margin-top: 10px;"> <p>Warning</p> <p>Click OK to have the Zyxel Device apply the configuration file and reboot. Click Cancel to stop the Zyxel Device from applying the configuration file.</p> <div style="text-align: right;"> <input type="button" value="OK"/> <input type="button" value="Cancel"/> </div> </div>

Table 238 Maintenance > Firmware/File Manager > Configuration File (continued)

LABEL	DESCRIPTION
Email	<p>Use this button to have the Zyxel Device send the selected configuration file to a valid email address.</p> <p>Click a configuration file's row to select it and click Email to have the Zyxel Device mail that configuration file. The following screen displays.</p> 
E-mail Subject	Enter a email subject text with 1-60 characters. It may consist of letters, numbers, and the following special characters: '()+,./:=?;!*"#\$%&-
Email To	Enter up to 83 characters for the email address of the receiver.
Email Content	Enter the backup email body text using 1 to 251 single-byte characters, including 0-9a-zA-Z!"#\$%&'()*+,-./:;<=>@\]^_`{ } and spaces are allowed. ? is not allowed.
Encryption Password	Configuration files are zipped when they are emailed. For security, enter an unzip password to require the recipient to use this password to unzip the configuration file. The password cannot exceed 128 characters. Valid characters are [0-9a-zA-Z~!@#%&^&*()_-=+{} ;:<>./]. If you do not set a password here, then none is needed to unzip the configuration file.
Send Email	Click this to send the email to the email address you configured.
Cancel	Click this to close the screen.
Upload	Click this to upload a new or previously saved configuration file from your computer to your Zyxel Device. You cannot upload a configuration file named system-default.conf , startup-config.conf or lastgood.conf .
File Path	Type in the location of the file you want to upload in this field or click Browse ... to find it.
Browse...	Click Browse... to find the .conf file you want to upload. The configuration file must use a ".conf" filename extension. You will receive an error message if you try to upload a file of a different format. Remember that you must decompress compressed (.zip) files before you can upload them.
Upload	Click Upload to begin the upload process. This process may take up to two minutes.
Cancel	Click this to close the screen.

Table 238 Maintenance > Firmware/File Manager > Configuration File (continued)

LABEL	DESCRIPTION
Test	<p>Before applying a configuration file to the Zyxel Device, you can select the file and click Test to check if the configuration file has errors.</p> <p>Configuration Test: Pass - The configuration file is correct.</p> <p>Configuration Test: Fail - An error was found in the configuration file. Applying a configuration file with errors may cause malfunctions in your Zyxel Device.</p> <p>To see details on errors, download the log file using FTP from /tmp/apply-config-error.log. The log file indicates which CLI line had errors. Contact customer support if errors cannot be solved.</p> <p>Note: Make sure startup-config.conf does not have an error before you restart the Zyxel Device or upload new firmware.</p>
File Name	<p>This column displays the label that identifies a configuration file.</p> <p>You cannot change the following configuration files their file names.</p> <p>The system-default.conf file contains the Zyxel Device's default settings. Select this file and click Apply to reset all of the Zyxel Device settings to the factory defaults. This configuration file is included when you upload a firmware package.</p> <p>The startup-config.conf file is the configuration file that the Zyxel Device is currently using. If you make and save changes during your management session, the changes are applied to this configuration file. The Zyxel Device applies configuration changes made in the Web Configurator to the configuration file when you click Apply or OK. It applies configuration changes made through commands when you use the <code>write</code> command.</p> <p>The lastgood.conf is the most recently used (valid) configuration file that was saved when the device last restarted. If you upload and apply a configuration file with an error, you can apply lastgood.conf to return to a valid configuration.</p>
Size	This column displays the size (in KB) of a configuration file.
Last Modified	This column displays the date and time that the individual configuration files were last changed or saved.
Configure Backup Schedule	<p>Backups created by a schedule are given an automatic name by the Zyxel Device. The name of a scheduled backup file follows this format: 'backup-yyyy-mm-dd-hh-mm-ss'.conf. To restore a configuration file, click Upload to upload the file, then select the file and click Apply to apply the file to the Zyxel Device.</p>
Enable Auto Backup	<p>Select the check box to back up the running (current) configuration file automatically at a scheduled time.</p> <p>Note: After the first backup, subsequent back ups only occur if the configuration file is different from the previous backed up configuration file.</p>
Daily	Set the Zyxel Device to back up its current configuration file once a day at the specified hour and minute.
Weekly	Set the Zyxel Device to back up its current configuration file once a week on the specified day, at the specified hour and minute.
Monthly	<p>Set the Zyxel Device to back up its current configuration file once a month on the specified day, at the a specified hour and minute.</p> <p>Note: If the date you select is greater than the number of days in a month, the Zyxel Device automatically backs up its configuration file on the last day of the month. For example, if you select 31 and the month is February, the Zyxel Device backs up its configuration file on day 28 or 29.</p>
Send Email	Enable this to send the backed up configuration file to the email address(es) you configured.
Encryption Password	For security, enter a password for the recipient to unzip the compressed backup configuration file. Use 1 to 128 characters. [! \] are invalid.

Table 238 Maintenance > Firmware/File Manager > Configuration File (continued)

LABEL	DESCRIPTION
E-mail Subject	Enter a email subject text with 1-60 characters. It may consist of letters, numbers, and the following special characters: '()+,./:=?!*#@\$%-
Email To	Enter up to 83 characters for the email address of the receiver. You and send the configuration file to a maximum of five recipients.
Email Content	Enter the backup email body text using 1 to 251 single-byte characters, including 0-9a-zA-Z!"#\$%&'()*+,-./:;<=>@[\\]^_`{ } and spaces are allowed. ? is not allowed.
Recovery Manager	<p>This is a complete backup of the Zyxel Device that can be used if the Zyxel Device is faulty and needs to be replaced. You should save a complete back up to your computer each time you make a configuration change. You may also set a password for the configuration file. The backup files can then be restored on a replacement Zyxel Device.</p> <p>The Recovery Manager backup ZIP file includes the following:</p> <p>Configuration files</p> <p>Contains all configuration files from the Maintenance > Firmware/File Manager > Configuration File screen.</p> <p>Certificates</p> <ul style="list-style-type: none"> • IPsec VPN certificates: Used to establish secure site-to-site VPN connections. • Remote access VPN certificates: Used for secure remote access to the Zyxel Device through VPN. • Trusted certificates: Certificates that you have set the Zyxel Device to accept as trusted. <p>Google Authenticator File</p> <p>Contains two-factor authentication (2FA) information. Google Authenticator adds an extra layer of security for local users accessing the Zyxel Device or a secured network behind the Zyxel Device through a VPN tunnel.</p>
Status	<p>This displays the status of the file backup. You must first backup the file to the Zyxel Device and then download to your computer. This ZIP file does not display in the Configuration list.</p> <ul style="list-style-type: none"> • Done - The ZIP file have been successfully saved to the Zyxel Device. • None - No backup has been made. • Failed - The backup failed. Ensure the Internet is working. <p>Click the Backup button to set up the backup. The following screen appears.</p> <div data-bbox="513 1249 1209 1564" style="border: 1px solid black; padding: 5px;"> <p>Backup System Configuration ✕</p> <p>Enter password to backup the full system configuration file. This password will be required to restore the configuration.</p> <p>Password <input style="width: 100px;" type="password" value="....."/> </p> <p style="text-align: right;"> <input type="button" value="Cancel"/> <input type="button" value="Backup"/> </p> </div>
Password	Enter a password for the backup ZIP file. You will need this password to restore the file on the replacement Zyxel Device. It can contain 8 to 128 single-byte characters, including 0-9, a-z, A-Z, and the following characters: ~!@#%&^&*()_+={} ;:<>.,? Spaces are not allowed. This field cannot be blank.
Cancel	Click Cancel to exit this screen without saving.
Backup	Click Backup to save the backup ZIP file to the Zyxel Device.
File Name	This displays the name of the backup ZIP file that will be downloaded to your computer. You can rename the file when you are saving it to your computer.

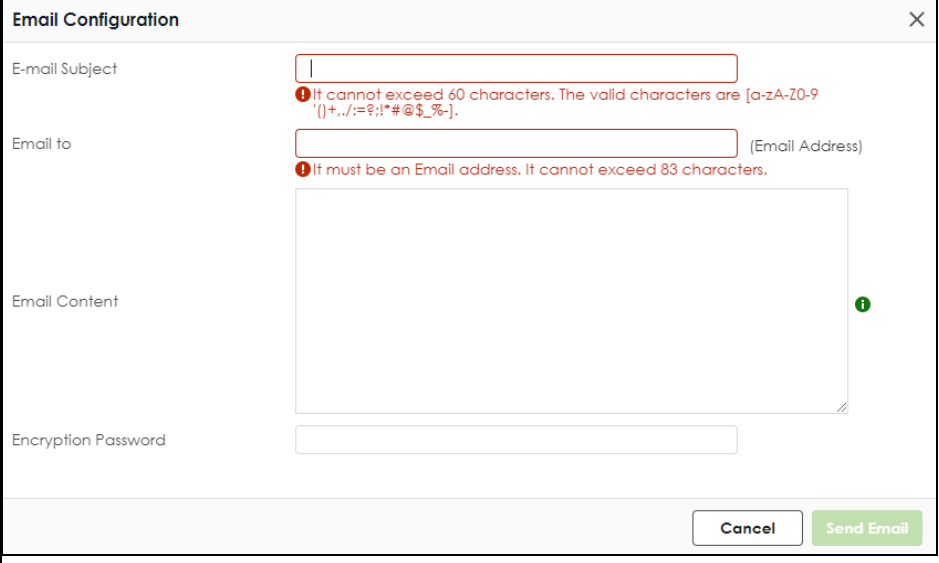
Table 238 Maintenance > Firmware/File Manager > Configuration File (continued)

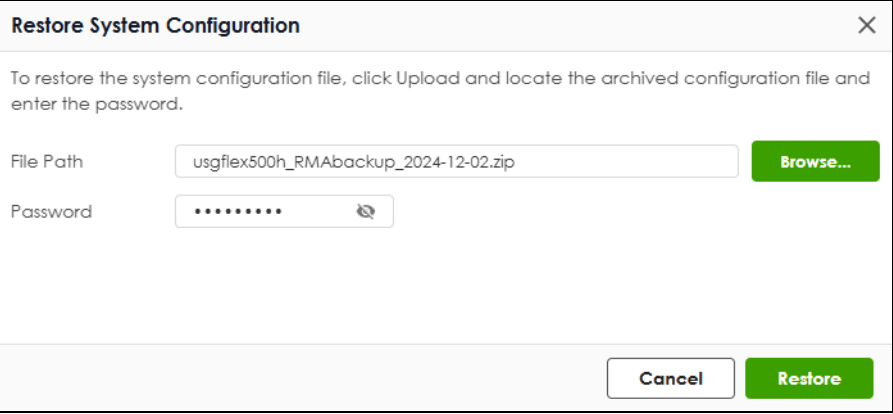
LABEL	DESCRIPTION
Backup Date/Time	This field displays the date and time when the backup file were saved to the Zyxel Device. The format is yyyy-mm-dd hh:mm:ss.
File Size	This field displays the file size of the backup ZIP file that will be downloaded to your computer.
Download	Click Download to save the backup file to your computer in ZIP format.
Restore	<p>Click Restore to upload an Recovery Manager backup ZIP file to the replacement Zyxel Device. Check that the replacement Zyxel Device has firmware version 1.31 or later. The following screen appears.</p>  <p>Note: The replacement Zyxel Device must be the same model with the exact same firmware version as the one on which the backup was done.</p>
File Path	Click Browse to select a backup ZIP file on your computer that you want to upload.
Password	Enter the password for the backup file created during the backup.
Cancel	Click Cancel to exit this screen without saving.
Restore	Click Restore to upload the backup file to the replacement Zyxel Device. The Zyxel Device automatically reboots when you apply the new backup file.
Apply	Click Apply to save your changes back to the Zyxel Device.
Cancel	Click Cancel to return the screen to its last-saved settings.

28.2.1 Example: Back Up and Restore Zyxel Device Configuration

It is recommended that you back up your configuration file before making further configuration changes. This ensures you can restore to previous device settings if new changes cause problems.

Here are the default configuration files on the Zyxel Device:

- The **system-default.conf** file is the configuration file that resets all of the Zyxel Device settings to the factory defaults.
- The **startup-config.conf** file is the configuration file that the Zyxel Device is currently using.
- The **lastgood.conf** is the most recently used (valid) configuration file that was saved when the device last restarted.

Back Up the Current Configuration

Follow these steps to save the current configuration file from the Zyxel Device to your computer:

- 1 Go to **Maintenance > Firmware/File Manager**, select **startup-config.conf**, and click **Download** to save the configuration file to your computer.

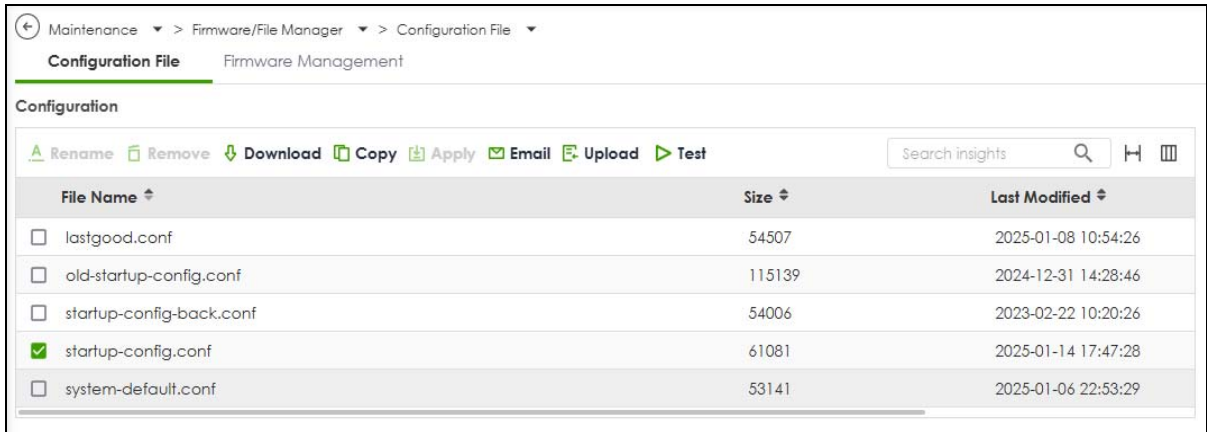

- 2 Rename the downloaded configuration file with the current date.

Upload a Configuration File to the Zyxel Device

Follow these steps to upload a previously saved configuration file from your computer to the Zyxel Device:

- 1 Go to **Maintenance > Firmware/File Manager** and click **Upload**.

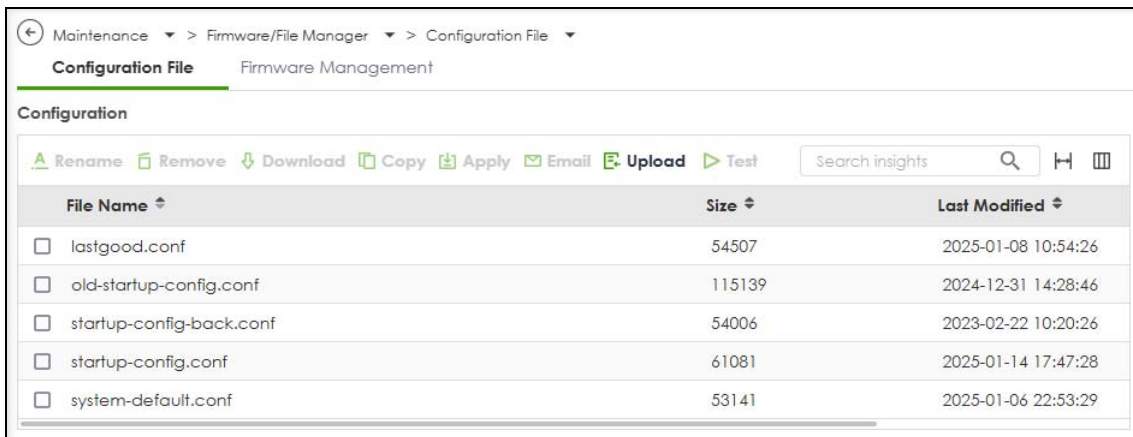

- 2 Click **Browse...** to locate the .conf file on your computer to restore, then click **Upload**.

Note: The configuration file must have a ".conf" filename extension. You cannot upload a file named **system-default.conf**, **startup-config.conf**, or **lastgood.conf**.

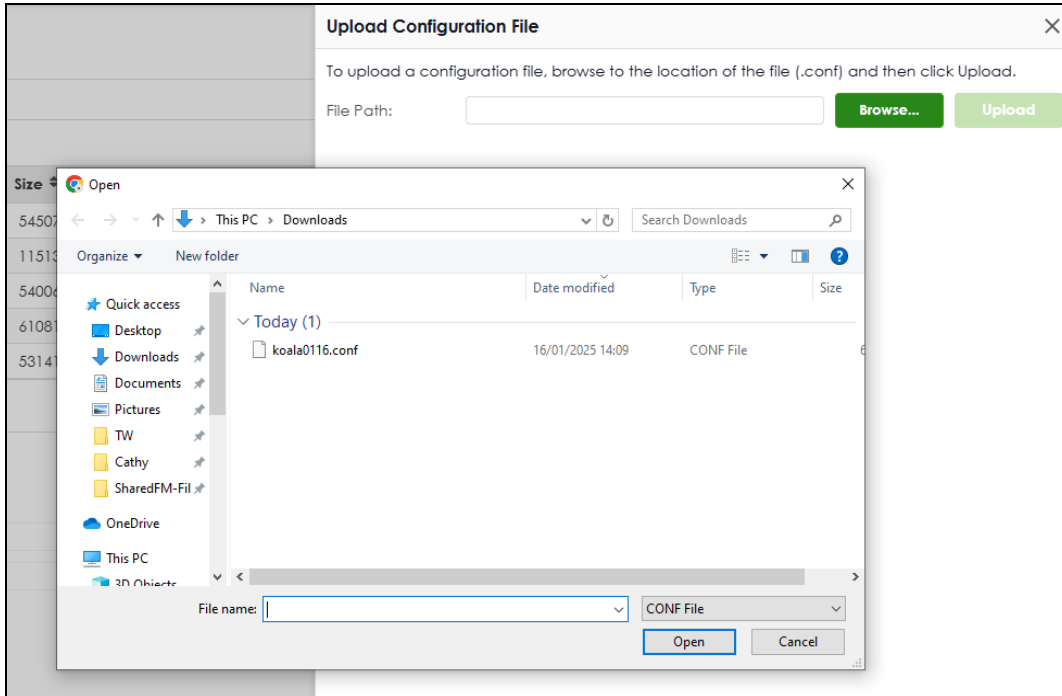

- 3 Select the configuration file and click **Apply** to have the Zyxel Device use the configuration file.

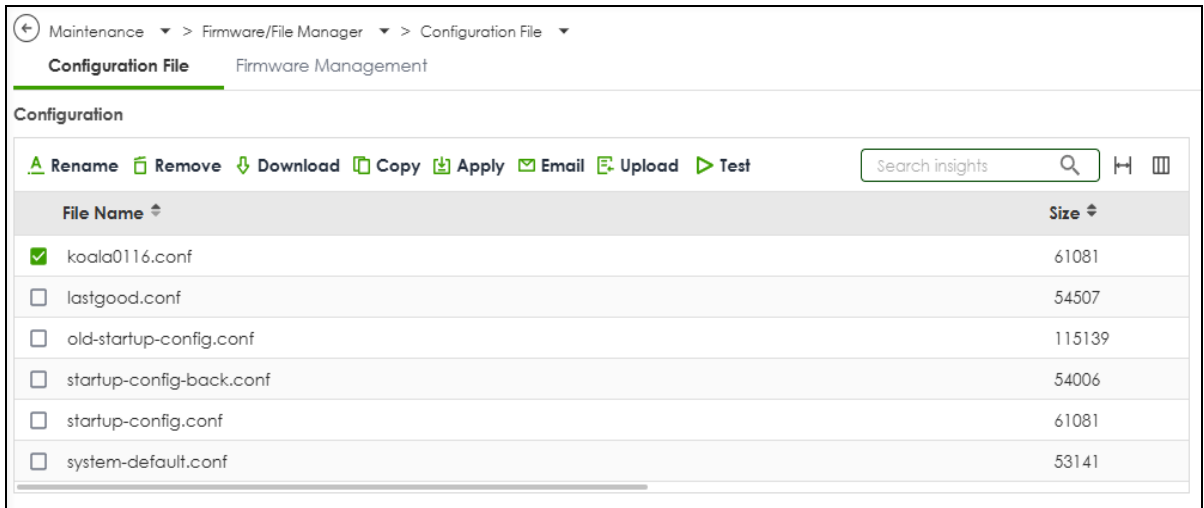

28.3 Firmware Management

Use the **Firmware Management** screen to check your current firmware version and upload firmware to the Zyxel Device.

Note: The Web Configurator is the recommended method for uploading firmware. You only need to use the command line interface if you need to recover the firmware. See the CLI Reference Guide for how to determine if you need to recover the firmware and how to recover it.

Find the firmware file in a folder that (usually) uses the system model name with the model code and a bin extension. For example, a firmware for USG FLEX 200HP is "100ABEX0b3s1.bin".



Note: The Zyxel Device restarts automatically when you upload new firmware.

28.3.1 Cloud Helper

Cloud Helper lets you know if there is a later firmware available on the Cloud Helper server and lets you download it if there is.

Note: Go to NCC, create an account and register your Zyxel Device first. Then you will be able to get notifications on new firmware available when you log into the Zyxel Device web configurator.

Table 239 Cloud Helper Firmware Icons

<p>Cloud Firmware</p> 	<p>Cloud firmware is being downloaded from the Cloud Helper Server.</p>
<p>Local Firmware</p> 	<p>Use this if you have already downloaded the latest firmware from the Zyxel website to your computer and unzipped it.</p> <p>Click the icon and then browse to the location of the unzipped files.</p> <div data-bbox="683 873 1360 1577" style="border: 1px solid #ccc; padding: 10px;"> <p style="text-align: right; margin: 0;">Local Firmware ✕</p> <p style="font-size: small; margin: 5px 0;">To upload firmware, browse to the location of the file (*.bin) and then click Upload.</p> <p>File Path : <input style="width: 200px;" type="text"/> <input type="button" value="Browse..."/> <input type="button" value="Upload"/></p> <hr style="border: 0; border-top: 1px solid #ccc; margin: 10px 0;"/> <p style="text-align: right; margin: 0;"><input type="button" value="Cancel"/></p> </div> <p>The Zyxel Device will reboot automatically when it finishes uploading.</p>

28.3.2 The Firmware Management Screen

Click **Maintenance > Firmware/File Manager > Firmware Management** to open the **Firmware Management** screen.

Note: The Zyxel Device automatically reboots when you upload new firmware.

Figure 301 Maintenance > Firmware/File Manager > Firmware Management

Firmware Management

Firmware Status

Status	Model	Version	Release Date	Action
Running	USG FLEX 200HP	V1.30(ABXE.1)	2024-11-08 08:04:35	

Cloud Firmware Information

Latest Version: V1.31(ABXE.0) **Check Now**

Release Date: 2025-01-08 05:22:20

Release Note: [Release Notes Document](#)

Auto Update:
 Daily 00 (Hour)
 Weekly 00 (Day) (Hour)

Note

1. Sometimes, networking threats occur that can seriously compromise the security of your network. Zyxel will react immediately to release patch firmware that will combat these serious threats. This firmware upgrade is mandatory and Zyxel will notify you of a time frame to upgrade the firmware.

2. Schedule Reboot and Auto Firmware Update functions are mutually exclusive. If Auto Firmware Update enabled, then you cannot set Schedule Reboot and vice versa.

The following table describes the labels in this screen.

Table 240 Maintenance > Firmware/File Manager > Firmware Management

LABEL	DESCRIPTION
Status	This displays the running firmware status.
Model	This is the model name of the device which the firmware is running on.
Version	The firmware on each Zyxel Device is identified by the firmware trunk version, followed by a unique code which identifies the model, and then the release number after the period. For example, V1.31 (ABXE.0) is a firmware for the 1.31 version trunk, the ABXE code identifies the USG FLEX 200HP model, and .0 is the first firmware release for the model.
Released Date	This is the date that the version of the firmware was created.
Action	Click to upload a firmware from your computer to the Zyxel Device. Click Upload to upload the firmware as the running firmware after the Zyxel Device reboots. Your current configuration settings will be saved and applied after reboot. Click to download a later firmware from the Cloud Helper Server. This icon shows if there is a later firmware on the Cloud Helper Server than the running firmware on your Zyxel Device.
Cloud Firmware Information	You must register your Zyxel Device at NCC first to use cloud firmware.
Latest Version	This displays the latest firmware version at the Cloud Helper Server.
Check Now	Click Check Now to see if there is a later firmware on the Cloud Helper Server than the running firmware on your Zyxel Device.
Release Date	This displays the date the latest firmware version was made available.
Release Note	The release note contains details of latest firmware version such as new features and bug fixes.
Auto Update	If you have not enabled Schedule Reboot in Maintenance > Reboot/Shutdown , you may use Auto Update in this screen to have the Zyxel Device automatically check for and download new firmware at a particular time each day, or at a particular time once a week. The Zyxel Device will automatically reboot after new firmware is downloaded. You should select a time when your network is not busy for minimal interruption.
Daily	Select this option to have the Zyxel Device check for new firmware every day at the specified time. The time format is the 24 hour clock, so '0' means midnight for example.
Weekly	Select this option to have the Zyxel Device check for new firmware once a week on the day and at the time specified.

Table 240 Maintenance > Firmware/File Manager > Firmware Management (continued)

LABEL	DESCRIPTION
Apply	Click Apply to save your changes back to the Zyxel Device.
Cancel	Click Cancel to return the screen to its last-saved settings.

CHAPTER 29

Diagnostics

29.1 Overview

Use the diagnostics screens for troubleshooting.

29.1.1 What You Can Do in this Chapter

- Use the **Diagnostics** screens (see [Section 29.2 on page 496](#)) to generate a file containing the Zyxel Device's configuration and diagnostic information if you need to provide it to customer support during troubleshooting.
- Use the **Packet Capture** screens (see [Section 29.3 on page 498](#)) to capture packets going through the Zyxel Device.
- Use the **CPU / Memory Status** screens (see [Section 29.4 on page 502](#)) to view the CPU and memory performance of various applications on the Zyxel Device.
- Use the **System Log** screen (see [Section 29.4 on page 502](#)) to view the files of diagnostic information the Zyxel Device has collected and stored on a connected USB storage device.
- Use the **Network Tool** screen (see [Section 29.6 on page 505](#)) to ping an IP address or trace the route packets take to a host.

29.2 The Diagnostics Screens

The **Diagnostics** screens provide an easy way for you to generate a file containing the Zyxel Device's configuration and diagnostic information. You may need to send this file to customer support for troubleshooting.

29.2.1 The Diagnostics Screen

Click **Maintenance > Diagnostics > Diagnostics** to open the following screen. When you click **Collect Now**, a series of commands are run to display information about the Zyxel Device.

This screen also lists the files of diagnostic information the Zyxel Device has collected and stored on the Zyxel Device or in a connected USB storage device. You may need to send these files to customer support for troubleshooting.

Figure 302 Maintenance > Diagnostics > Diagnostics

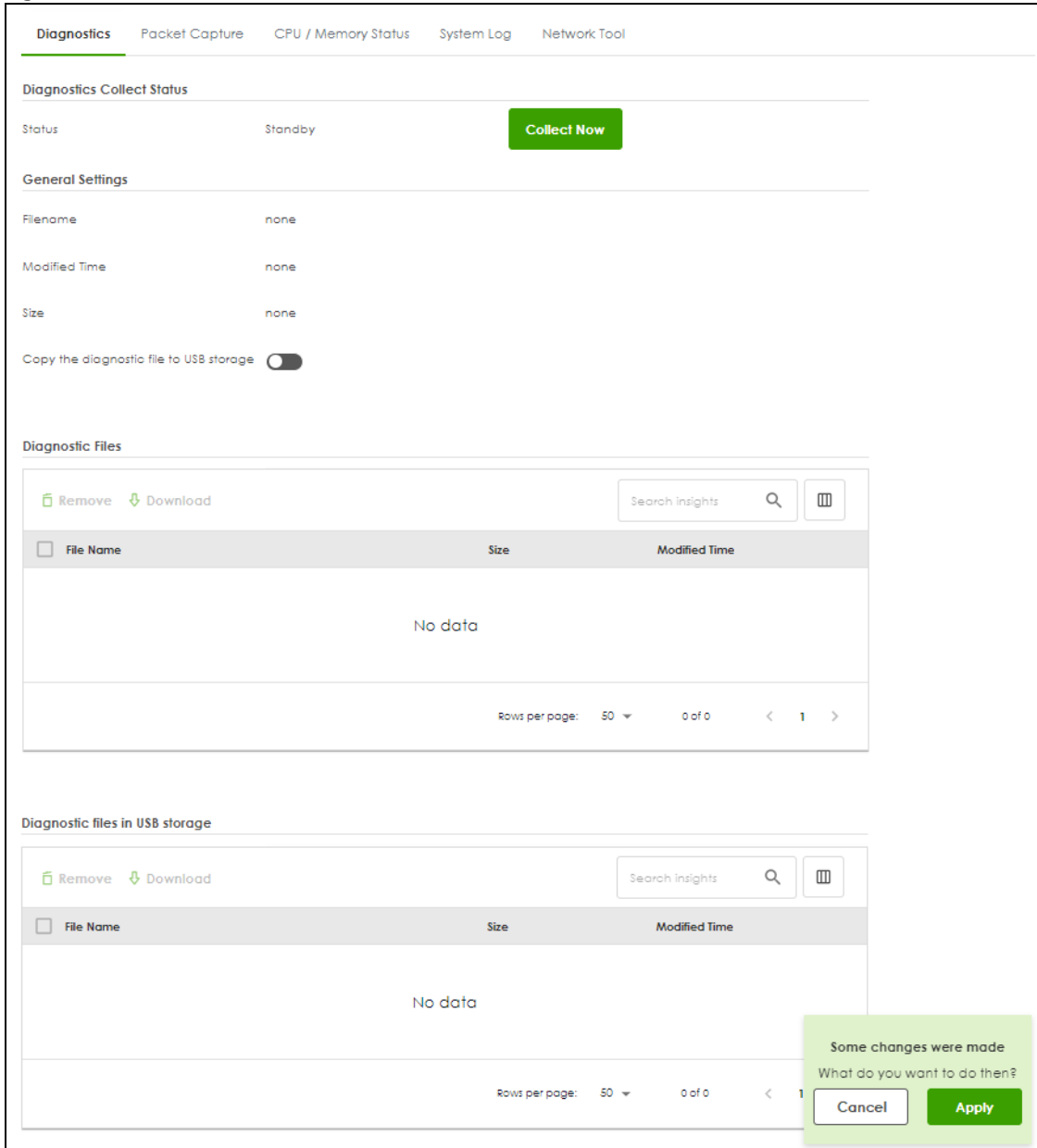

The following table describes the labels in this screen.

Table 241 Maintenance > Diagnostics > Diagnostics

LABEL	DESCRIPTION
Diagnostics Collect Status	
Status	<p>This field displays the following states the Zyxel Device is in when collecting diagnostic data.</p> <ul style="list-style-type: none"> • Standby: The Zyxel Device is ready to generate a diagnostic file or has just finished generating a diagnostic file. • Busy on device: The Zyxel Device is generating a diagnostic file containing its own configuration and diagnostic information.
Collect Now	<p>Click this to have the Zyxel Device run the uploaded script and create a new diagnostic file. Please wait until the collection finishes.</p>

Table 241 Maintenance > Diagnostics > Diagnostics (continued)

LABEL	DESCRIPTION
General Setting	
Filename	This is the name of the most recently created diagnostic file.
Modified Time	This is the date and time that the last diagnostic file was created. The format is yyyy-mm-dd hh:mm:ss.
Size	This is the size of the most recently created diagnostic file.
Copy the diagnostic file to USB storage	Select this to have the Zyxel Device create an extra copy of the diagnostic file to a connected USB storage device.
Diagnostic files	This lists the files of generated diagnostic information stored on the Zyxel Device.
Diagnostic files in USB storage	This lists the files of generated diagnostic information stored in a connected USB storage device.
Remove	Select files and click Remove to delete them from the Zyxel Device or the USB storage device.
Download	Click a file to select it and click Download to save it to your computer.
#	This column displays the number for each file entry. The total number of files that you can save depends on the file sizes and the available storage space.
File Name	This column displays the label that identifies the file.
Size	This column displays the size (in bytes) of a file.
Modified Time	This column displays the date and time that the individual files were saved.

29.3 The Packet Capture Screen

Click **Maintenance > Diagnostics > Packet Capture** to open the packet capture files screen. This screen lists the files of packet captures stored on the Zyxel Device or a connected USB storage device. You can download the files to your computer where you can study them using a packet analyzer (also known as a network or protocol analyzer) such as Wireshark.

Figure 303 Maintenance > Diagnostics > Packet Capture



The following table describes the labels in this screen.

Table 242 Maintenance > Diagnostics > Packet Capture

LABEL	DESCRIPTION
Edit	Click this to configure packet capture settings.
Interface	This field displays the interface for which to capture packets.
Protocol	This field displays the protocol of traffic for which to capture packets.
Host	this field displays the host IP address object for which to capture packets.
Host Port	This field displays the port number of traffic to capture.
File/Split Size (MB)	This field displays the maximum size limit in megabytes for individual packet capture files.
Storage	This field displays where the packet capture entry is saved.
Capture	<p>Click this button to have the Zyxel Device capture packets according to the settings configured in this screen.</p> <p>You can configure the Zyxel Device while a packet capture is in progress although you cannot modify the packet capture settings.</p> <p>The Zyxel Device's throughput or performance may be affected while a packet capture is in progress.</p> <p>After the Zyxel Device finishes the capture it saves a separate capture file for each selected interface. The total number of packet capture files that you can save depends on the file sizes and the available flash storage space. Once the flash storage space is full, adding more packet captures will fail.</p>
Remove	Select files and click Remove to delete them from the Zyxel Device or the connected USB storage device.
Download	Click a file to select it and click Download to save it to your computer.
File Name	This column displays the label that identifies the file. The file name format is interface name-file suffix.cap.
Size	This column displays the size (in bytes) of a configuration file.
Modified Time	This column displays the date and time that the individual files were saved.

29.3.1 The Packet Capture Edit Screen

Use this screen to capture network traffic going through the Zyxel Device's interfaces. Studying these packet captures may help you identify network problems. Click **Maintenance > Diagnostics > Packet Capture > Edit** to open the packet capture screen.

Note: New capture files overwrite existing files of the same name. Change the **File Suffix** field's setting to avoid this.

Figure 304 Maintenance > Diagnostics > Packet Capture > Edit

The following table describes the labels in this screen.

Table 243 Maintenance > Diagnostics > Packet Capture > Edit

LABEL	DESCRIPTION
Interfaces	Select interfaces for which to capture packets and click the right arrow button to move them to the right.
IP Version	Select the version of IP for which to capture packets. Select any to capture packets for all IP versions.
Protocol Type	Select the protocol of traffic for which to capture packets. Select any to capture packets for all types of traffic.

Table 243 Maintenance > Diagnostics > Packet Capture > Edit (continued)

LABEL	DESCRIPTION
Host IP	Select a host IP address object for which to capture packets. Select any to capture packets for all hosts. Select User Defined to be able to enter an IP address.
Host Port	This field is configurable when you set the IP Type to any , tcp , or udp . Specify the port number of traffic to capture.
Captured Packet Files	<p>When saving packet captures only to the Zyxel Device's on board storage, specify a maximum limit in megabytes for the total combined size of all the capture files on the Zyxel Device.</p> <p>When saving packet captures to a connected USB storage device, specify a maximum limit in megabytes for each capture file.</p> <p>Note: If you have existing capture files and have not selected the Continuously capture and overwrite old ones option, you may need to set this size larger or delete existing capture files.</p> <p>The valid range depends on the available on board/USB storage size. The Zyxel Device stops the capture and generates the capture file when either the file reaches this size or the time period specified in the Duration field expires.</p>
Split threshold	Specify a maximum size limit in megabytes for individual packet capture files. After a packet capture file reaches this size, the Zyxel Device starts another packet capture file.
Duration	Set a time limit in seconds for the capture. The Zyxel Device stops the capture and generates the capture file when either this period of time has passed or the file reaches the size specified in the File Size field. 0 means there is no time limit.
File Suffix	<p>Specify text to add to the end of the file name (before the dot and filename extension) to help you identify the packet capture files. Modifying the file suffix also avoids making new capture files that overwrite existing files of the same name.</p> <p>The file name format is "interface name-file suffix.cap", for example "vlan2-packet-capture.cap".</p>
Number Of Bytes To Capture (Per Packet)	Specify the maximum number of bytes to capture per packet. The Zyxel Device automatically truncates packets that exceed this size. As a result, when you view the packet capture files in a packet analyzer, the actual size of the packets may be larger than the size of captured packets.
Save data to onboard storage only	<p>Select this to have the Zyxel Device only store packet capture entries on the Zyxel Device. The available storage size is displayed as well.</p> <p>Note: The Zyxel Device reserves some on board storage space as a buffer.</p>
Save data to USB storage	<p>Select this to have the Zyxel Device store packet capture entries only on a USB storage device connected to the Zyxel Device if the Zyxel Device allows this. The USB file format should be FAT32.</p> <p>Status:</p> <p>Unused - the connected USB storage device was manually unmounted by using the Remove Now button or for some reason the Zyxel Device cannot mount it.</p> <p>none - no USB storage device is connected.</p> <p>service deactivated - USB storage feature is disabled (in System > USB Storage), so the Zyxel Device cannot use a connected USB device to store system logs and other diagnostic information.</p> <p>available - you can have the Zyxel Device use the USB storage device. The available storage capacity also displays.</p> <p>Note: The Zyxel Device reserves some USB storage space as a buffer.</p>
Save data to ftp server	Select this to have the Zyxel Device store packet capture entries on the defined FTP site. The available storage size is displayed as well.

Table 243 Maintenance > Diagnostics > Packet Capture > Edit (continued)

LABEL	DESCRIPTION
Server Address	Type the IP address of the FTP server.
Server Port	Type the port this server uses for FTP traffic. The default FTP port is 21.
Name	Type the login username to access the FTP server.
Password	Type the associated login password to access the FTP server.

29.4 The CPU / Memory Status Screen

Click **Maintenance > Diagnostics > CPU / Memory Status** to open the **CPU/Memory Status** screen. Use this screen to view the CPU and memory performance of various applications on the Zyxel Device.

Figure 305 Maintenance > Diagnostics > CPU / Memory Status

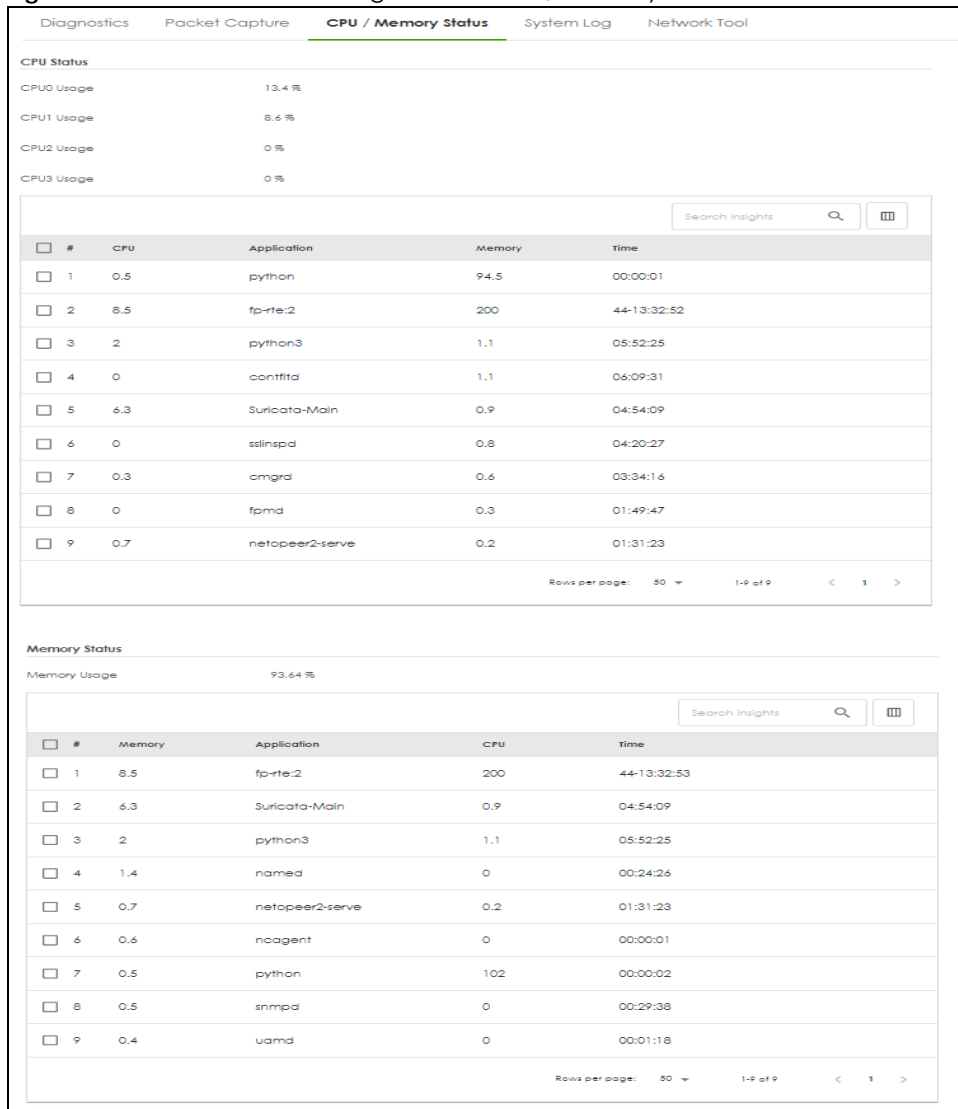

The following table describes the labels in this screen.

Table 244 Maintenance > Diagnostics > CPU / Memory Status

LABEL	DESCRIPTION
Refresh	Click this to update the information in this screen.
CPU Status	
This table displays the applications that use the most Zyxel Device CPU processing.	
CPU Usage	CPU usage shows how much processing power the Zyxel Device is using. This field displays the current percentage usage of a CPU (where n is the number of the CPU) as a percentage of total processing power. CPU usage may appear temporarily high when creating graphic-intensive statistics and reports. You may ignore it, and observe the long-term usage.
#	This field is a sequential value, and it is not associated with any entry.
CPU	This field displays the current CPU utilization percentage for each application used on the Zyxel Device.
Application	This field displays the name of the application consuming the related processing power on the Zyxel Device.
Memory	This field displays the current DRAM memory utilization percentage for each application used on the Zyxel Device.
Time	This field displays each application's running time in hours - minutes - seconds.
Memory Status	
This table displays the applications that use the most Zyxel Device DRAM memory.	
Memory Usage	Memory usage shows how much DRAM memory the Zyxel Device is using. This field displays the current percentage of memory utilization.
#	This field is a sequential value, and it is not associated with any entry.
Memory	This field displays the current DRAM memory utilization percentage for each application used on the Zyxel Device.
Application	This field displays the name of the application consuming the related memory on the Zyxel Device.
CPU	This field displays the current CPU utilization percentage for each application used on the Zyxel Device.
Time	This field displays each application's running time.

29.5 The System Log Screen

Click **Maintenance > Diagnostics > System Log** to open the **System Log** screen. This screen lists the files of diagnostic information the Zyxel Device has collected and stored on a connected USB storage device. You may need to send these files to customer support for troubleshooting.

Figure 306 Maintenance > Diagnostics > System Log

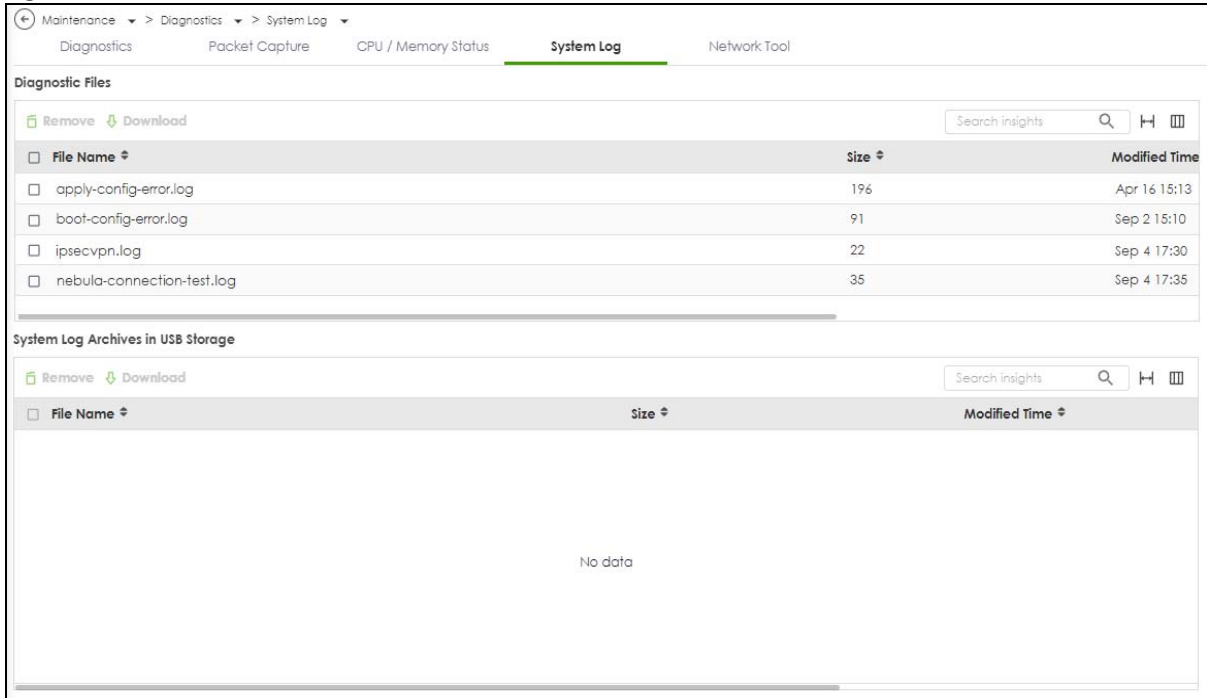

The following table describes the labels in this screen.

Table 245 Maintenance > Diagnostics > System Log

LABEL	DESCRIPTION
Diagnostic Files	
Remove	Select files and click Remove to delete them from the Zyxel Device. A pop-up window asks you to confirm that you want to delete.
Download	Select a file and click Download to save it to your computer.
File Name	This column displays the label that identifies the file. <ul style="list-style-type: none"> The apply-config-error.log file logs the configuration file the Zyxel Device is applying. The boot-config-error.log file logs errors that occur during the Zyxel Device's booting process. The ipsecvpn.log file logs events related to IPsec VPN connections. If the Zyxel Device is disconnected from the NCC, the nebula-connection-test.log file will log the Zyxel Device's Internet connection status and the NCC connection status.
Size	This column displays the size (in bytes) of a file.
Modified Time	This column displays the date and time that the individual files were saved.
System Log Archives in USB Storage	
Remove	Select files and click Remove to delete them from the USB storage device. A pop-up window asks you to confirm that you want to delete.
Download	Select a file and click Download to save it to your computer.
File Name	This column displays the label that identifies the file.
Size	This column displays the size (in bytes) of a file.
Modified Time	This column displays the date and time that the individual files were saved.

29.6 The Network Tool Screen

Use this screen to perform various network tests.

Click **Maintenance > Diagnostics > Network Tool** to display this screen.

Figure 307 Maintenance > Diagnostics > Network Tool

The screenshot shows the 'Network Tool' interface with the following elements:

- Navigation tabs: Diagnostics, Packet Capture, CPU / Memory Status, System Log, **Network Tool**.
- Network Tool dropdown menu: PING IPv4.
- Domain Name or IP Address input field: 8.8.8.8.
- Advanced Settings section with a scroll arrow.
- Query Server and Extension Option input fields (disabled).
- Test and Reset buttons.
- Output log showing ping results:

```
PING 8.8.8.8 (8.8.8.8) 56(84) bytes of data:
64 bytes from 8.8.8.8: icmp_seq=1 ttl=112 time=13.7 ms
64 bytes from 8.8.8.8: icmp_seq=2 ttl=112 time=7.66 ms
64 bytes from 8.8.8.8: icmp_seq=3 ttl=112 time=5.64 ms

--- 8.8.8.8 ping statistics ---
3 packets transmitted, 3 received, 0% packet loss, time 2001ms
rtt min/avg/max/mdev = 5.644/9.011/13.733/3.438 ms
```

Figure 308 Maintenance > Diagnostics > Network Tool > IPsec Trace Log

The screenshot shows the 'IPSec Trace Log' interface with the following elements:

- Network Tool dropdown menu: IPsec Trace Log.
- Debug Level input field: 2. (Optional, valid value: 0 - 4, empty is default: 1)
- Start and Stop buttons.
- Output log showing system logs:

```
Sep 18 15:05:59 07[LIB] reloaded configuration of 'revocation' plugin
Sep 18 15:05:59 07[CFG] loaded 0 entries for attr plugin configuration
Sep 18 15:05:59 07[LIB] reloaded configuration of 'attr' plugin
Sep 18 15:05:59 07[LIB] reloaded configuration of 'kernel-netlink' plugin
Sep 18 15:05:59 07[LIB] reloaded configuration of 'bypass-lan' plugin
Sep 18 15:05:59 07[CFG] loaded 1 RADIUS server configuration
Sep 18 15:05:59 07[LIB] reloaded configuration of 'eap-radius' plugin
Sep 18 15:05:59 07[IKE] zyxel hack set interval in 10s
Sep 18 15:05:59 07[IKE] zyxel hack set like_timeout in 60s
Sep 18 15:05:59 07[IKE] zyxel hack set nailup_timeout in 30s
Sep 18 15:05:59 07[LIB] reloaded configuration of 'zyxel-hack' plugin
Sep 18 15:05:59 02[JOB] watcher got notification, rebuilding
Sep 18 15:05:59 02[JOB] watcher going to poll() 6 fds
Sep 18 15:05:59 02[JOB] watched FD 18 ready to write
Sep 18 15:05:59 02[JOB] watcher going to poll() 5 fds
```

Figure 309 Maintenance > Diagnostics > Network Tool > Nebula Status

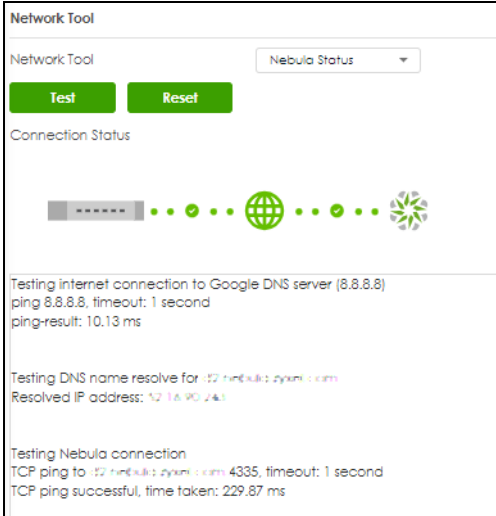

The following table describes the labels in this screen.

Table 246 Maintenance > Diagnostics > Network Tool

LABEL	DESCRIPTION
<p>Network Tool</p>	<p>Select a network tool from the list.</p> <div style="border: 1px solid black; padding: 2px; margin-bottom: 10px;"> <p>NSLOOKUP IPv4</p> <p>PING IPv4</p> <p>TRACEROUTE IPv4</p> <p>IPSec Trace Log</p> <p>Nebula Status</p> </div> <ul style="list-style-type: none"> • Select NSLOOKUP IPv4 to perform name server lookup for querying the Domain Name System (DNS) to get the domain name or IP address mapping. • Select PING IPv4 to ping the IP address that you entered. • Select TRACEROUTE IPv4 to run the traceroute function. This determines the path a packet takes to the specified computer. • Select IPSec Trace Log to run the strongSwan debug log function. • Select Nebula Status to test the connection from the Zyxel Device to the Nebula Control Center (NCC). <p>This screen displays if the test passes.</p> <div style="border: 1px solid black; padding: 2px; margin-bottom: 10px;"> </div> <p>This screen displays if the test fails.</p> <div style="border: 1px solid black; padding: 2px;"> </div>
<p>Domain Name or IP Address</p>	<p>Type the IP address that you want to use to for the NSLOOKUP, PING and TRACEROUTE network tools.</p>

Table 246 Maintenance > Diagnostics > Network Tool (continued)

LABEL	DESCRIPTION
Debug Level	<p>This field displays when you choose the IPSec Trace Log network tool. Select a log level from 0 to 4, then click Start. Wait, or click Stop to see the log result. The higher the log level, the more detailed the log.</p> <p>The debug log levels are as follows:</p> <ul style="list-style-type: none"> • 0: Very basic auditing logs, such as SA up / down) • 1: Generic control flow with errors (default) • 2: Contains more detailed control flow logs • 3: Includes RAW data dumps in hex • 4: Includes sensitive material such as keys.
Test	This field displays when you choose the Nebula Status network tool. Click Test , then wait for the result. Click Reset to remove the results and test again.
Advanced Settings	
Query Server	This field appears when you choose NSLOOKUP IP v4 . Enter the IP address of a server to which the Zyxel Device sends queries for NSLOOKUP.
Interface	This field appears when you choose PING IPv4 or TRACEROUTE IPv4 . Select an interface from which to ping the specified IP address when running PING IPv4 or route to the specified IP address when running TRACEROUTE IPv4 .
Extension Option	Enter the extended option if you want to use an extended ping or traceroute command. For example, enter " <code>-c count</code> " (where <i>count</i> is the number of ping requests) to set how many times the Zyxel Device pings the destination IP address. Enter " <code>-w waittime</code> " (where <i>waittime</i> is a time period in seconds) to set how long the Zyxel Device waits for a response to a probe before running another traceroute.
Test	Click this button to start the test.
Reset	Click this button to return the screen to its last-saved settings.

CHAPTER 30

Packet Flow Explore

30.1 Overview

Use this to get a clear picture on how the Zyxel Device determines where to forward a packet and how to change the source IP address of the packet according to your current settings. This function provides you a summary of all your routing and SNAT settings and helps troubleshoot any related problems.

30.1.1 What You Can Do in this Chapter

- Use the **Routing Status** screen (see [Section 30.2 on page 508](#)) to view the overall routing flow and each routing function's settings.
- Use the **SNAT Status** screen (see [Section 30.3 on page 514](#)) to view the overall source IP address conversion (SNAT) flow and each SNAT function's settings.

30.2 Routing Status

The **Routing Status** screen allows you to view the current routing flow and quickly link to specific routing settings. Click a function box in the **Routing Flow** section, the related routes (activated) will display in the **Routing Table** section. To access this screen, click **Maintenance > Packet Flow Explore > Routing Status**.

Different features may have overlapping criteria that trigger different actions for the same traffic. Packet Flow Explore defines the order that features check criteria. This resolves conflicts when criteria overlap in different features. Features that may encounter overlapping criteria are:

- Routing
- NAT

Note: Once a packet matches the criteria of a routing rule, the Zyxel Device takes the corresponding action and does not perform any further flow checking.

Note: If you use the `vrf main routing policy-route override-direct-route` command, the Zyxel Device will prioritize **Policy Route** over **Direct Route** for packets routing.

Dynamic/SiteToSite VPN

This is where packets are forwarded according to the criteria you configure in **VPN > IPSec VPN > Site to Site VPN**.

Figure 310 Maintenance > Packet Flow Explore > Routing Status (Dynamic/SiteToSite VPN)

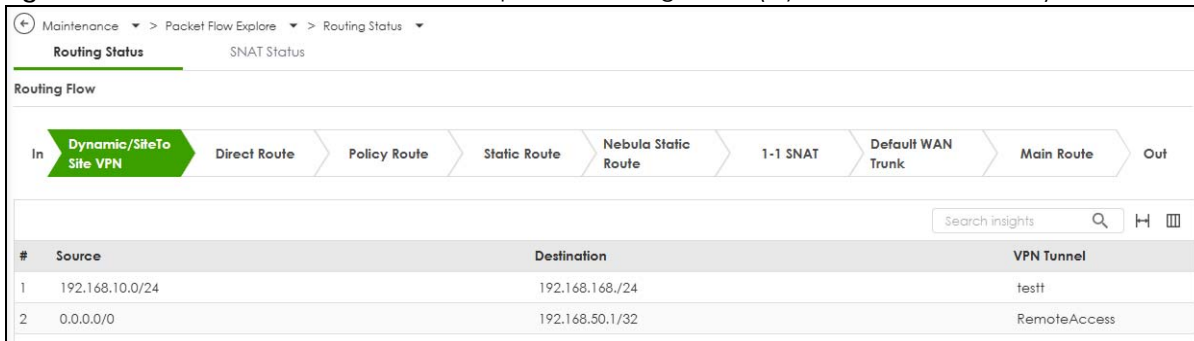

The following table describes the labels in this screen.

Table 247 Maintenance > Packet Flow Explore > Routing Status (Dynamic/SiteToSite VPN)

LABEL	DESCRIPTION
Routing Flow	This section shows you the flow of how the Zyxel Device determines where to route a packet. Click a function box to display the related settings in the routing table section.
Routing Table	This section shows the corresponding settings according to the function box you click in the Routing Flow section.
#	This field is a sequential value, and it is not associated with any entry.
Source	This is the IP address(es) of the local VPN network.
Destination	This is the IP address(es) for the remote VPN network.
VPN Tunnel	This is the name of the VPN tunnel.

Direct Route

This is where packets are sent to directly connected subnets.

Figure 311 Maintenance > Packet Flow Explore > Routing Status (Direct Route)



The following table describes the labels in this screen.

Table 248 Maintenance > Packet Flow Explore > Routing Status (Direct Route)

LABEL	DESCRIPTION
Routing Flow	This section shows you the flow of how the Zyxel Device determines where to route a packet. Click a function box to display the related settings in the routing table section.
Routing Table	This section shows the corresponding settings according to the function box you click in the Routing Flow section.
#	This field is a sequential value, and it is not associated with any entry.

Table 248 Maintenance > Packet Flow Explore > Routing Status (Direct Route) (continued)

LABEL	DESCRIPTION
Destination	This is the destination IP address of a route.
Interface	This is the name of an interface associated with the route.

Policy Route

This is where packets are forwarded according to the criteria you configure in **Network > Routing > Policy Route**.

Figure 312 Maintenance > Packet Flow Explore > Routing Status (Policy Route)

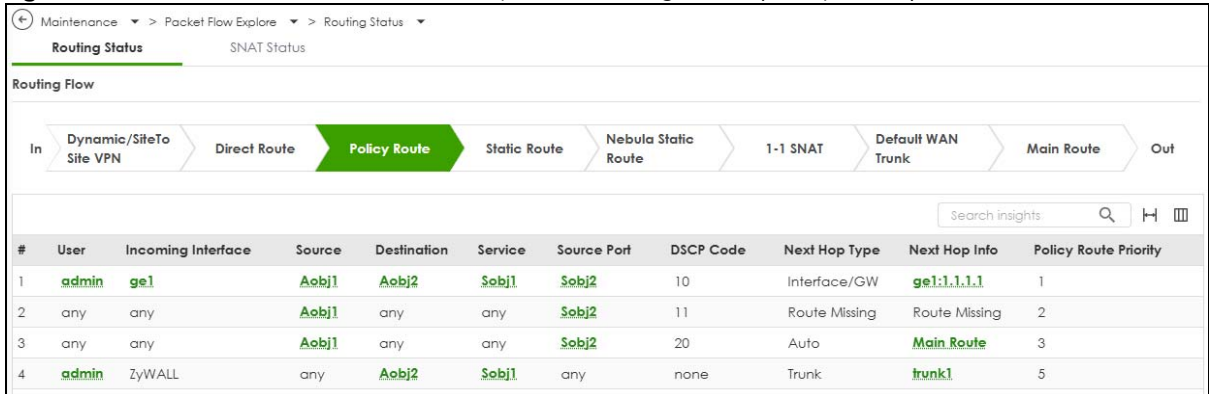

The following table describes the labels in this screen.

Table 249 Maintenance > Packet Flow Explore > Routing Status (Policy Route)

LABEL	DESCRIPTION
Routing Flow	This section shows you the flow of how the Zyxel Device determines where to route a packet. Click a function box to display the related settings in the routing table section.
Routing Table	This section shows the corresponding settings according to the function box you click in the Routing Flow section.
#	This field is a sequential value, and it is not associated with any entry.
User	This is the name of the user (group) object from which the packets are sent. any means all users.
Incoming Interface	This is the interface on which the packets are received.
Source	This is the source IP address(es) from which the packets are sent.
Destination	This is the destination IP address(es) to which the packets are transmitted.
Service	This is the name of the service object. any means all services.
Source Port	This is the source port(s) from which the packets are sent.
DSCP Code	This is the DSCP value of incoming packets to which this policy route applies.
Next Hop Type	This is the type of the next hop to which packets are directed.
Next Hop Info	<ul style="list-style-type: none"> This is the main route if the next hop type is Auto. This is the interface name and gateway IP address if the next hop type is Interface /GW. This is the trunk name if the next hop type is Trunk.
Policy Route Priority	Enter the priority of the rule on the Zyxel Device. The Zyxel Device uses this priority to determine which rule to apply. The lower the number, the higher the priority.

Static Route

This is where packets are forwarded according to the criteria you configured in **Network > Routing > Static Route**.

Figure 313 Maintenance > Packet Flow Explore > Routing Status (Static Route)

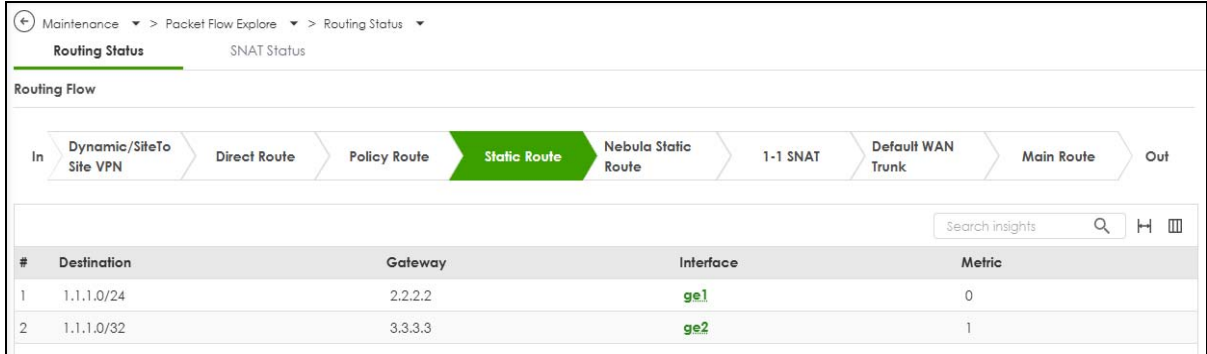

The following table describes the labels in this screen.

Table 250 Maintenance > Packet Flow Explore > Routing Status (Static Route)

LABEL	DESCRIPTION
Routing Flow	This section shows you the flow of how the Zyxel Device determines where to route a packet. Click a function box to display the related settings in the routing table section.
Routing Table	This section shows the corresponding settings according to the function box you click in the Routing Flow section.
#	This field is a sequential value, and it is not associated with any entry.
Destination	This is the destination IP address of a route.
Gateway	This is the IP address of the next-hop gateway or the interface through which the traffic is routed.
Interface	This is the name of an interface associated with the route.
Metric	This is the route's priority among the displayed routes. The lower the number, the higher the priority.

Nebula Static Route

This is the static route created when you are using Nebula VPN.

Figure 314 Maintenance > Packet Flow Explore > Routing Status (Nebula Static Route)

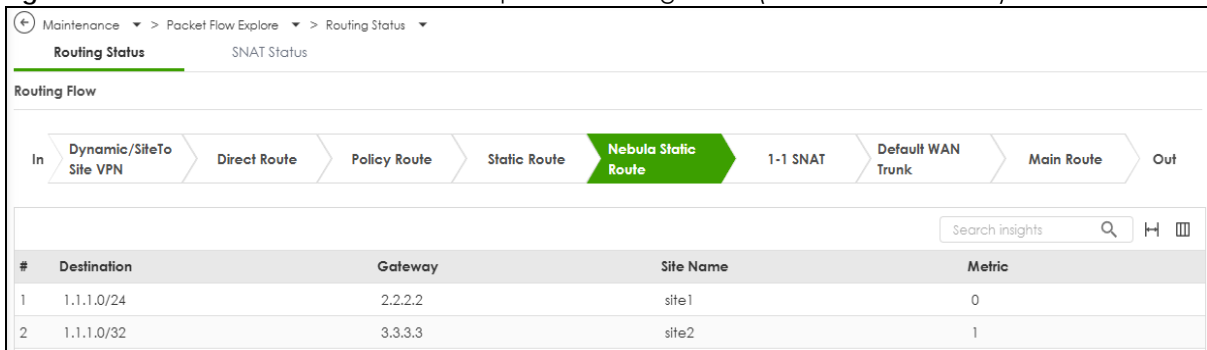

The following table describes the labels in this screen.

Table 251 Maintenance > Packet Flow Explore > Routing Status (Nebula Static Route)

LABEL	DESCRIPTION
Routing Flow	This section shows you the flow of how the Zyxel Device determines where to route a packet. Click a function box to display the related settings in the routing table section.
Routing Table	This section shows the corresponding settings according to the function box you click in the Routing Flow section.
#	This field is a sequential value, and it is not associated with any entry.
Destination	This is the destination IP address of a route.
Gateway	This is the IP address of the next-hop gateway or the interface through which the traffic is routed.
Destination Site	This is the Nebula site name of the next-hop gateway or the interface through which the traffic is routed.
Metric	This is the route's priority among the displayed routes. The lower the number, the higher the priority.

1-1 SNAT

This maps an internal private IP address to a single external public IP address for outbound traffic.

Figure 315 Maintenance > Packet Flow Explore > Routing Status (1-1 SNAT)

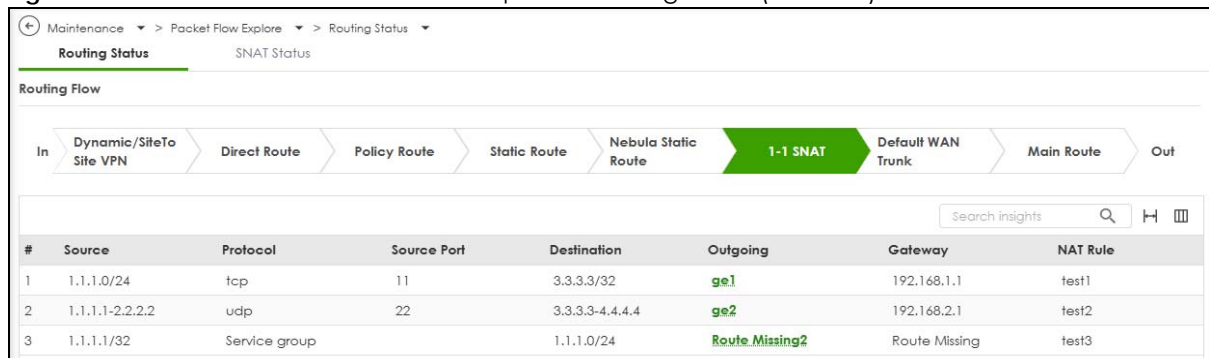

The following table describes the labels in this screen.

Table 252 Maintenance > Packet Flow Explore > Routing Status (1-1 SNAT)

LABEL	DESCRIPTION
Routing Flow	This section shows you the flow of how the Zyxel Device determines where to route a packet. Click a function box to display the related settings in the routing table section.
Routing Table	This section shows the corresponding settings according to the function box you click in the Routing Flow section.
#	This field is a sequential value, and it is not associated with any entry.
Source	This is the external source IP address(es).
Protocol	This is the transport layer protocol.
Source Port	This is the source port number.
Destination	This is the external destination IP address(es).
Outgoing	This is the outgoing interface that the SNAT rule uses to transmit packets.
Gateway	This is the IP address of the gateway in the same network of the outgoing interface.
NAT Rule	This is the name of an activated 1:1 or Many 1:1 NAT rule in the NAT table.

Default WAN Trunk

This is where packets are forwarded to the active interface in a WAN trunk and then onto the destination IP address.

Figure 316 Maintenance > Packet Flow Explore > Routing Status (Default WAN Trunk)

#	Source	Destination	Trunk	Algorithm	Member
1	any	any	trunk1	Least Load First	ge1, active, alive ge2, passive, dead ge1_ppp, passive, alive

The following table describes the labels in this screen.

Table 253 Maintenance > Packet Flow Explore > Routing Status (Default WAN Trunk)

LABEL	DESCRIPTION
Routing Flow	This section shows you the flow of how the Zyxel Device determines where to route a packet. Click a function box to display the related settings in the routing table section.
Routing Table	This section shows the corresponding settings according to the function box you click in the Routing Flow section.
#	This field is a sequential value, and it is not associated with any entry.
Source	This is the source IP address(es) from which the packets are sent. any means any IP address.
Destination	This is the destination IP address(es) to which the packets are transmitted. any means any IP address.
Trunk	This is the name of the WAN trunk through which the matched packets are transmitted.
Algorithm	<p>This displays the load balancing method of the WAN trunk.</p> <p>Select Weighted Round Robin to balance the traffic load between interfaces based on their respective weights. An interface with a larger weight gets more chances to transmit traffic than an interface with a smaller weight. For example, if the weight ratio of wan1 and wan2 interfaces is 2:1, the Zyxel Device chooses wan1 for 2 sessions' traffic and wan2 for 1 session's traffic in each round of 3 new sessions.</p> <p>Select Least Load First to send new session traffic through the least utilized trunk member.</p> <p>Select Spillover to send network traffic through the first interface in the group member list until there is enough traffic that the second interface needs to be used (and so on).</p>
Member	This displays the trunk member's interface(s).

Main Route

This is the default routing table of the Zyxel Device system kernel where packets are forwarded onto the destination IP address.

Figure 317 Maintenance > Packet Flow Explore > Routing Status (Main Route)

#	Destination	Gateway	Interface	Metric
1	0.0.0.0	2.2.2.2	ge1	0
2	8.8.8.8/32	2.2.2.100	ge1	3
3	2.2.2.0/24	N/A	ge1	0
4	192.168.1.0/24	N/A	ge1	0

The following table describes the labels in this screen.

Table 254 Maintenance > Packet Flow Explore > Routing Status (Main Route)

LABEL	DESCRIPTION
Routing Flow	This section shows you the flow of how the Zyxel Device determines where to route a packet. Click a function box to display the related settings in the routing table section.
Routing Table	This section shows the corresponding settings according to the function box you click in the Routing Flow section.
#	This field is a sequential value, and it is not associated with any entry.
Destination	This is the destination IP address(es) to which the packets are transmitted. any means any IP address.
Gateway	This is the IP address of the gateway in the same network of the outgoing interface.
Interface	This is the name of an interface associated with the route.
Metric	This is the route's priority among the displayed routes. The lower the number, the higher the priority.

30.3 The SNAT Status Screen

The **SNAT Status** screen allows you to view and quickly link to specific source NAT (SNAT) settings. Click a function box in the **SNAT Flow** section, the related SNAT rules (activated) will display in the **SNAT Table** section. To access this screen, click **Maintenance > Packet Flow Explore > SNAT Status**.

Note: Once a packet matches the criteria of an SNAT rule, the Zyxel Device takes the corresponding action and does not perform any further flow checking.

The order of the SNAT flow may vary depending on whether you:

- Enable/disable **Default SNAT** in the **Network > Interface > Edit External** interface screen.

SitetoSite VPN SNAT

SNAT for policy-based **SitetoSite IPsec VPN** maps all internal private IP addresses of a site to a single IP address for outbound traffic.

Figure 318 Maintenance > Packet Flow Explore > SNAT Status (SitetoSite VPN SNAT)

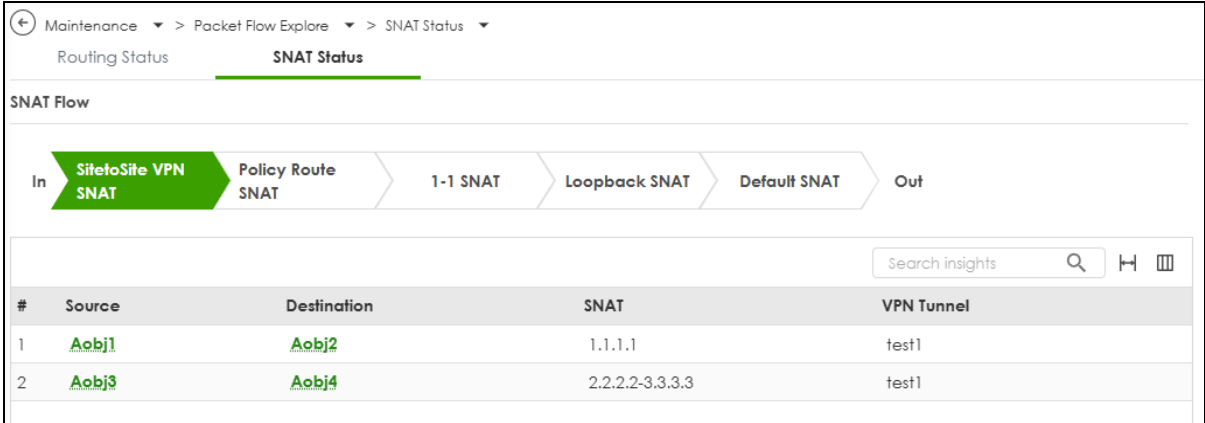

The following table describes the labels in this screen.

Table 255 Maintenance > Packet Flow Explore > SNAT Status (SitetoSite VPN SNAT)

LABEL	DESCRIPTION
SNAT Flow	This section shows you the flow of how the Zyxel Device changes the source IP address for a packet according to the rules you have configured in the Zyxel Device. Click a function box to display the related settings in the SNAT Table section.
SNAT Table	The table fields in this section vary depending on the function box you select in the SNAT Flow section.
#	This field is a sequential value, and it is not associated with any entry.
Source	This is the external source IP address(es).
Destination	This is the external destination IP address(es).
SNAT	This is the source IP address(es) that the SNAT rule uses finally.
VPN Tunnel	This is the name of the VPN tunnel.

Policy Route SNAT

This is where packets are forwarded according to the criteria you configured in **Network > Routing > Policy Route**, with the private source IP address of the sender replaced with a public IP address for outbound traffic.

Figure 319 Maintenance > Packet Flow Explore > SNAT Status (Policy Route SNAT)

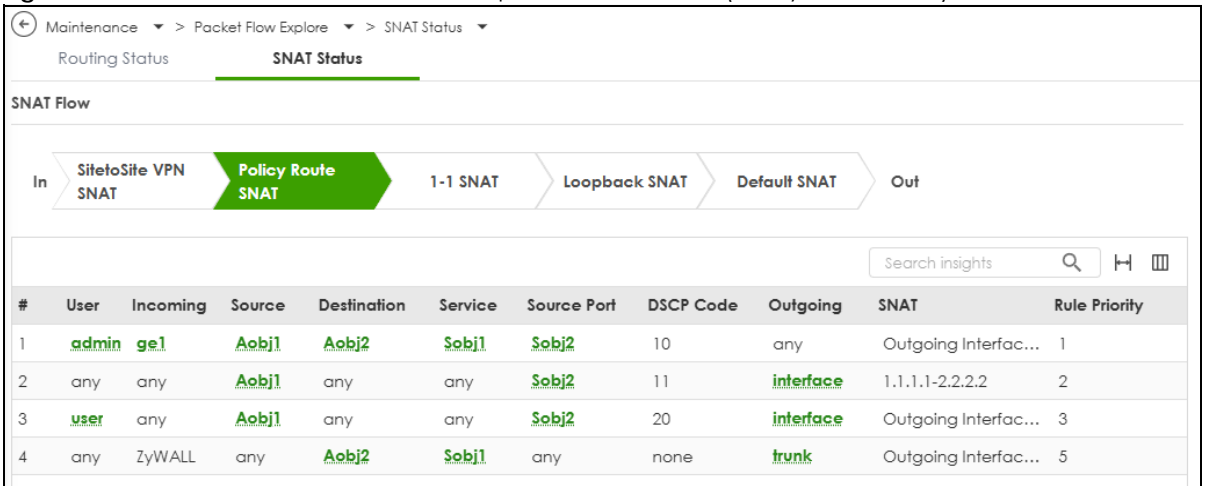

The following table describes the labels in this screen.

Table 256 Maintenance > Packet Flow Explore > SNAT Status (Policy Route SNAT)

LABEL	DESCRIPTION
SNAT Flow	This section shows you the flow of how the Zyxel Device changes the source IP address for a packet according to the rules you have configured in the Zyxel Device. Click a function box to display the related settings in the SNAT Table section.
SNAT Table	The table fields in this section vary depending on the function box you select in the SNAT Flow section.
#	This field is a sequential value, and it is not associated with any entry.
User	This is the name of the user (group) object from which the packets are sent. any means all users.
Incoming	This is the interface on which the packets are received.
Source	This is the source IP address(es) from which the packets are sent.
Destination	This is the destination IP address(es) to which the packets are transmitted.
Service	This is the name of the service object. any means all services.
Source Port	This is the source port(s) from which the packets are sent.
DSCP Code	This is the DSCP value of incoming packets to which this policy route applies.
Outgoing	This is the outgoing interface that the route uses to transmit packets.
SNAT	This is the source IP address(es) that the SNAT rule uses finally.
Rule Priority	Enter the priority of the rule on the Zyxel Device. The Zyxel Device decides which gateway to use based on this priority. The lower the number, the higher the priority.

1-1 SNAT

1-1 SNAT maps an internal private IP address to a single external public IP address for outbound traffic.

Figure 320 Maintenance > Packet Flow Explore > SNAT Status (1-1 SNAT)

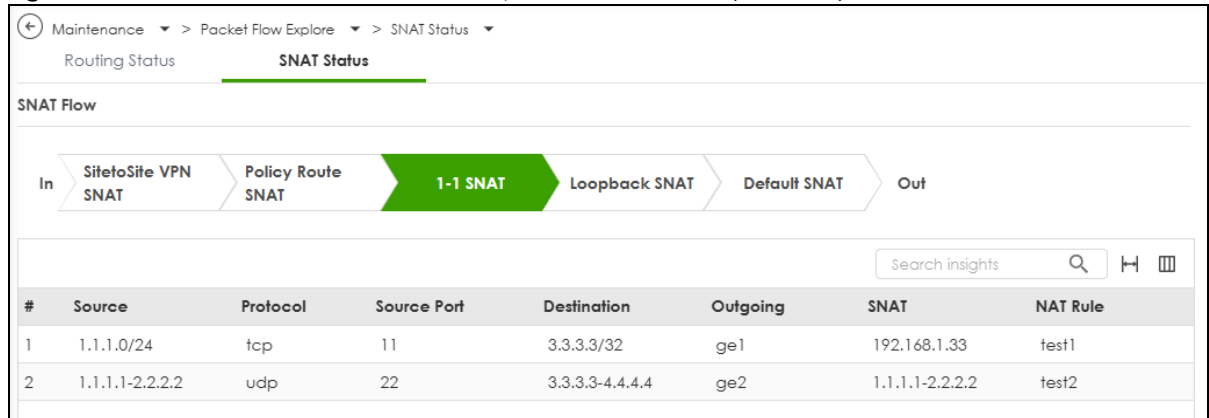

The following table describes the labels in this screen.

Table 257 Maintenance > Packet Flow Explore > SNAT Status (1-1 SNAT)

LABEL	DESCRIPTION
SNAT Flow	This section shows you the flow of how the Zyxel Device changes the source IP address for a packet according to the rules you have configured in the Zyxel Device. Click a function box to display the related settings in the SNAT Table section.
SNAT Table	The table fields in this section vary depending on the function box you select in the SNAT Flow section.

Table 257 Maintenance > Packet Flow Explore > SNAT Status (continued)(1-1 SNAT)

LABEL	DESCRIPTION
#	This field is a sequential value, and it is not associated with any entry.
Source	This is the external source IP address(es).
Protocol	This is the transport layer protocol.
Source Port	This is the source port number.
Destination	This is the external destination IP address(es).
Outgoing	This is the outgoing interface that the SNAT rule uses to transmit packets.
SNAT	This is the source IP address(es) that the SNAT rule uses finally.
NAT Rule	This is the name of an activated NAT rule which uses SNAT.

Loopback SNAT

Loopback SNAT maps an internal private IP address to the public IP address of an internal server.

Figure 321 Maintenance > Packet Flow Explore > SNAT Status (Loopback SNAT)

#	Source	Destination	SNAT	NAT Rule
1	any	3.3.3.3/32	Outgoing Interface IP	test1
2	any	3.3.3.3-4.4.4.4	Outgoing Interface IP	test2

The following table describes the labels in this screen.

Table 258 Maintenance > Packet Flow Explore > SNAT Status (Loopback SNAT)

LABEL	DESCRIPTION
SNAT Flow	This section shows you the flow of how the Zyxel Device changes the source IP address for a packet according to the rules you have configured in the Zyxel Device. Click a function box to display the related settings in the SNAT Table section.
SNAT Table	The table fields in this section vary depending on the function box you select in the SNAT Flow section.
#	This field is a sequential value, and it is not associated with any entry.
Source	This is the original source IP address(es). any means any IP address.
Destination	This is the original destination IP address(es). any means any IP address.
SNAT	This indicates which source IP address the SNAT rule uses finally. For example, Outgoing Interface IP means that the Zyxel Device uses the IP address of the outgoing interface as the source IP address for the matched packets it sends out through this rule.
NAT Rule	This is the name of an activated NAT rule which uses SNAT and enables NAT loopback.

Default SNAT

Default SNAT maps internal private IP addresses to a single external public IP address for outbound traffic.

Figure 322 Maintenance > Packet Flow Explore > SNAT Status (Default SNAT)

#	Incoming	Outgoing	SNAT
1	Internal Interface	Internal Interface	Outgoing Interface IP
2	Remote Access VPN	External Interface	Outgoing Interface IP

The following table describes the labels in this screen.

Table 259 Maintenance > Packet Flow Explore > SNAT Status (Default SNAT)

LABEL	DESCRIPTION
SNAT Flow	This section shows you the flow of how the Zyxel Device changes the source IP address for a packet according to the rules you have configured in the Zyxel Device. Click a function box to display the related settings in the SNAT Table section.
SNAT Table	The table fields in this section vary depending on the function box you select in the SNAT Flow section.
#	This field is a sequential value, and it is not associated with any entry.
Incoming	This indicates internal interface(s) on which the packets are received.
Outgoing	This indicates external interface(s) from which the packets are transmitted.
SNAT	This indicates which source IP address the SNAT rule uses finally. For example, Outgoing Interface IP means that the Zyxel Device uses the IP address of the outgoing interface as the source IP address for the matched packets it sends out through this rule.

CHAPTER 31

Reboot/Shutdown

31.1 Overview

Use this screen to restart or turn off the Zyxel Device.

31.2 The Reboot/Shutdown Screen

To access this screen, click **Maintenance > Reboot/Shutdown**.

When you click **Reboot** or **Shutdown**, your current configurations made using the web configurator are saved.

Note: Your current configurations made using the command line interface (CLI) are not saved if you didn't use the `copy running startup` command to save the current configurations as the startup configurations.

Note: If **startup-config.conf** has an error, the Zyxel Device may restart with an older configuration file or the factory default configuration file with all your configurations lost. Use **Test** in **Maintenance > Firmware/File Manager > Configuration** to check that **startup-config.conf** does not have an error. See [Section 28.1.3 on page 483](#) for details on which configuration files are used at start-up.

Figure 323 Maintenance > Reboot/Shutdown

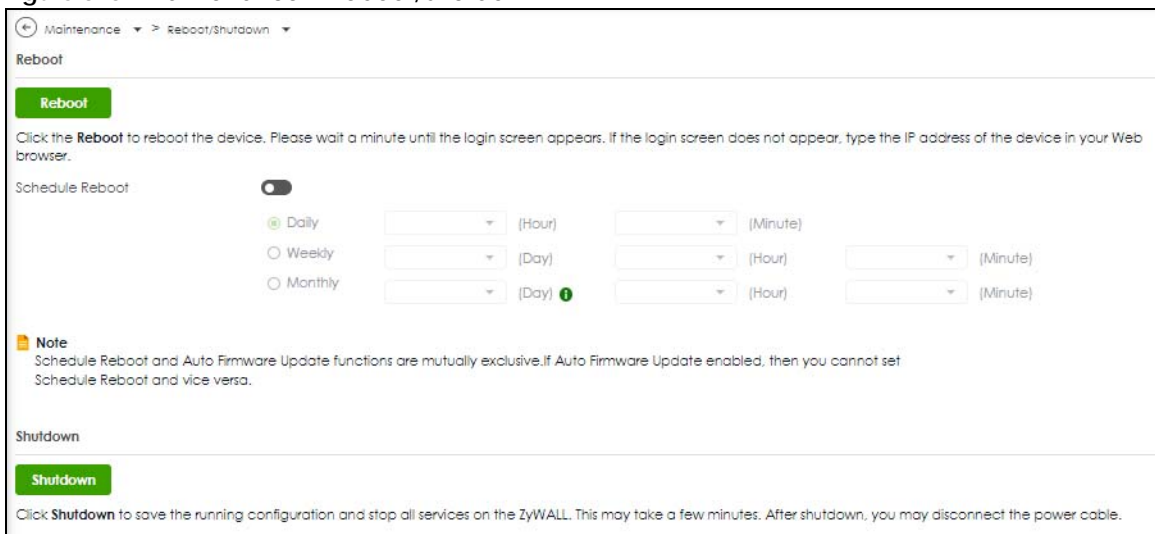

Click **Reboot** to restart the Zyxel Device immediately without turning the power off.

Alternatively, if you have not enabled **Auto Update** in **Maintenance > Firmware/File manager > Firmware Management**, you may use **Schedule Reboot** in this screen to automatically restart the Zyxel Device at a particular time each day, once a week, or once a month.

- Select **Daily** to have the Zyxel Device automatically restart every day at the specified time. The time format is the 24 hour clock, so '0' means midnight for example.
- Select **Weekly** to have the Zyxel Device automatically restart once a week on the day and at the time specified.
- Select **Monthly** to have the Zyxel Device automatically restart once a month on the day and at the time specified.

Click **Shutdown** to prepare the Zyxel Device to turn off. Wait for the **PWR/SYS** LED to turn off before you remove the Zyxel Device power cable.

PART III

Appendices and Troubleshooting

CHAPTER 32

Troubleshooting

This chapter offers some suggestions to solve problems you might encounter. You can also refer to the logs; see [Section 27.2 on page 470](#) for more information.

None of the LEDs turn on.

Make sure that you have the power cord connected to the Zyxel Device and plugged in to an appropriate power source. Make sure you have the Zyxel Device turned on. Check all cable connections.

If the LEDs still do not turn on, you may have a hardware problem. In this case, you should contact your local vendor.

Cannot access the Zyxel Device from the LAN.

- Check the cable connection between the Zyxel Device and your computer or switch.
- Ping the Zyxel Device from a LAN computer. Make sure your computer's Ethernet card is installed and functioning properly. Also make sure that its IP address is in the same subnet as the Zyxel Device's.
- In the computer, click **Start, (All) Programs, Accessories** and then **Command Prompt**. In the **Command Prompt** window, type "ping" followed by the Zyxel Device's LAN IP address (192.168.168.1 is the default) and then press [ENTER]. The Zyxel Device should reply.

If you've forgotten the Zyxel Device's password, use the **RESET** button. Press the button in for about 7 seconds (or until the **PWR/SYS** LED starts to blink), then release it. It returns the Zyxel Device to the default configuration with password is 1234, LAN IP address 192.168.168.1. All configuration files, including those you saved on the Zyxel Device, will be deleted.

- If you've forgotten the Zyxel Device's IP address, you can use the commands through the **CONSOLE** port to check it. Connect your computer to the **CONSOLE** port using a console cable. Your computer should have a terminal emulation communications program (such as HyperTerminal) set to VT100 terminal emulation, no parity, 8 data bits, 1 stop bit, no flow control and 115200 bps port speed.

I cannot access the Internet.

- Check the Zyxel Device's connection to the Ethernet jack with Internet access. Make sure the Internet gateway device (such as a DSL modem) is working properly.
- Check the WAN interface's status in the **Dashboard**. Use the installation setup wizard again and make sure that you enter the correct settings. Use the same case as provided by your ISP.

I cannot update the IPS/application patrol/IP reputation signatures.

- Make sure your Zyxel Device has the IPS/application patrol/IP reputation service registered and that the license is not expired. Purchase a new license if the license is expired.
- Make sure your Zyxel Device is connected to the Internet.

I downloaded updated IPS/application patrol/IP reputation signatures. Why has the Zyxel Device not re-booted yet?

The Zyxel Device does not have to reboot when you upload new signatures.

My Zyxel Device is not performing the action I set in **Security Service > IPS** when a stream of data matches a malicious signature.

Make sure you set the Zyxel Device to **Prevention** mode for the Zyxel Device to take action. The Zyxel Device only creates log messages in **Detection** mode and does not take action.

The content filtering category service is not working.

Make sure your Zyxel Device is connected to the Internet. Use the feedback link in the screen to give feedback on a link that should or should not be in a certain content filtering category.

I configured security settings but the Zyxel Device is not applying them for certain interfaces.

Many security settings are usually applied to zones. Make sure you assign the interfaces to the appropriate zones. When you create an interface, there is no security applied on it until you assign it to a zone.

The Zyxel Device is not applying the custom policy route I configured.

The Zyxel Device checks the policy routes in the order that they are listed. So make sure that your custom policy route comes before any other routes that the traffic would also match.

The Zyxel Device is not applying the custom security policy I configured.

The Zyxel Device checks the security policies in the order that they are listed. So make sure that your custom security policy comes before any other rules that the traffic would also match.

My rules and settings that apply to a particular interface no longer work.

The interface's IP address may have changed. To avoid this, create an IP address object based on the interface. This way the Zyxel Device automatically updates every rule or setting that uses the object whenever the interface's IP address settings change. For example, if you change LAN1's IP address, the Zyxel Device automatically updates the corresponding interface-based, LAN1 subnet address object.

I cannot set up a PPP interface.

You have to set up an ISP account before you can create a PPPoE or PPTP interface.

I cannot configure a particular VLAN interface on top of an Ethernet interface even though I have it configured on top of another Ethernet interface.

Each VLAN interface is created on top of only one Ethernet interface.

The Zyxel Device's performance slowed down after I configured many new application patrol entries.

The Zyxel Device checks the ports and conditions configured in application patrol entries in the order they appear in the list. While this sequence does not affect the functionality, you might improve the performance of the Zyxel Device by putting more commonly used ports at the top of the list.

The Zyxel Device's anti-malware scanner cleaned an infected file but now the receiver cannot use the file.

If the MD5 hash value is incorrect, then Anti-Malware removes the last packet of the file. The file is still forwarded to the receiver, but they will not be able to open it. The receiver is not notified if a file is modified by the Zyxel Device. If the file cannot be used, the receiver should contact the Zyxel Device administrator to confirm if the Zyxel Device modified the file by checking the logs.

The Zyxel Device sent an alert that a malware-infected file has been found, but the file was still forwarded to the user and could still be executed.

Make sure you enable **Destroy Infected File** in the **Security Services > Anti-Malware** screen to modify infected files before forwarding the files to the user, preventing them from being executed.

I added a file pattern in the anti-malware allow list, but the Zyxel Device still checks and modifies files that match this pattern.

Make sure you enable the anti-malware allow list. If it is already enabled, make sure that the allow list entry corresponding to this file pattern is activated.

The Zyxel Device's performance seems slower after configuring IPS.

Depending on your network topology and traffic load, binding every packet direction to an IPS profile may affect the Zyxel Device's performance. You may want to focus IPS scanning on certain traffic directions such as incoming traffic.

IPS is dropping traffic that matches a rule that says no action should be taken.

The Zyxel Device checks all signatures and continues searching even after a match is found. If two or more rules have conflicting actions for the same packet, then the Zyxel Device applies the more restrictive action (**reject-both**, **reject-receiver** or **reject-sender**, **drop**, **none** in this order). If a packet matches a rule for **reject-receiver** and it also matches a rule for **reject-sender**, then the Zyxel Device will reject-both.

The Zyxel Device's performance seems slower after configuring DoS Prevention.

Depending on your network topology and traffic load, applying an anomaly profile to each and every packet direction may affect the Zyxel Device's performance.

Some of the files I download don't go through Sandbox even though it is enabled.

The Sandbox feature only applies to certain file types. Check the list in **File Submission Options** to see if the file types you use are included. If they are, make sure you select their corresponding check box.

Sandbox detected a malicious file, but the file still went through the Zyxel Device and is still usable.

Make sure you set your Sandbox settings to destroy malicious files in the **Security Services > Sandbox: Action For Malicious File** drop-down list box.

The Zyxel Device destroyed/dropped a file/email without notifying me.

Make sure you enable logs for your security features, such as in the following screens:

- **Security Services > IPS**
- **Security Services > Anti-Malware**
- **Security Services > Sandbox**
- **Security Services > Reputation Filter**

The Zyxel Device routes and applies SNAT for traffic from some interfaces but not from others.

The Zyxel Device automatically uses SNAT for traffic it routes from internal interfaces to external interfaces. For example, SNAT is used for LAN to WAN traffic. You must manually configure a policy route to add routing and SNAT settings for an interface with the **Interface Type** set to **General**. You can also configure a policy route to override the default routing and SNAT behavior for an interface with the **Interface Type** set to **Internal** or **External**.

I cannot get Device HA to work.

Make sure to check the following:

- Both Zyxel Devices must be the same model with the same firmware version.
- Connect the Zyxel Devices using the correct heartbeat port. This is the highest-numbered copper Ethernet ports on the Zyxel Devices - see [Table 206 on page 423](#).
- The heartbeat port must not be in an interface that is already configured for other features.
- Enable Device HA on both Zyxel Devices.
- The management IP addresses for both the active and passive Zyxel Devices must be in the same subnet.
- SSH service in **System > SSH** must be enabled on both Zyxel Devices.

If you are using NCC to manage the Zyxel Device, check the following:

- Both Zyxel Devices must be registered to the same account.
- The primary Zyxel Device must be registered to a site.
- Both Zyxel Devices must be in the same organization.

You may see the following error message if Device HA fails.

- **Device firmware or model mismatch detected.** Check that both Zyxel Devices are the same model with the same firmware version. Update both Zyxel Devices to the latest firmware available.

You may see one of the following error messages if Device HA fails in On Cloud mode (when using NCC to manage the Zyxel Device).

Note: See the [Nebula Online Help](#) for instructions on how to register and manage Zyxel Devices in NCC.

After fixing the error, wait a few moments, then do the Device HA pairing process again.

- **Device registration failed.** Device registration fails if both Zyxel Devices are not in an organization. Go to NCC and add both Zyxel Devices to an organization.
- **Devices belong to different organizations.** Both Zyxel Devices must be in the same organization. Go to NCC and add both Zyxel Devices to the same organization.
- **Device ownership mismatch.** Check that both Zyxel Devices are registered to the same account.
- **Device is not assigned to a site.** The primary Zyxel Device must be registered to a site. Go to NCC, and add the primary Zyxel Device to a site.
- **Internal server error.** A NCC server issue occurred during the pairing process. Check that the Zyxel Device has a stable network connection to NCC. If the error persists, contact technical support with the error details.

I cannot get Dynamic DNS to work.

- You must have set up an account for Dynamic DNS service. These are supported at the time of writing.

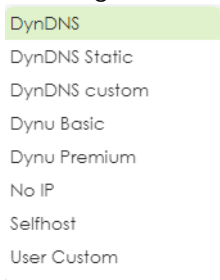

- Make sure you recorded your DDNS account's user name, password, and domain name and have entered them properly in the Zyxel Device.
- You must have a public WAN IP address to use Dynamic DNS.
- You may need to configure the DDNS entry's IP Address setting to **Auto** if the interface has a dynamic IP address or there are one or more NAT routers between the Zyxel Device and the DDNS server.
- The Zyxel Device may not determine the proper IP address if there is an HTTP proxy server between the Zyxel Device and the DDNS server.

I cannot get the application patrol to manage FTP traffic.

Make sure you have the FTP ALG enabled in **Network > ALG**.

The Zyxel Device keeps resetting the connection.

If an alternate gateway on the LAN has an IP address in the same subnet as the Zyxel Device's LAN IP address, return traffic may not go through the Zyxel Device. This is called an asymmetrical or "triangle" route. This causes the Zyxel Device to reset the connection, as the connection has not been acknowledged.

You can set the Zyxel Device's security policy to permit the use of asymmetrical route topology on the network (so it does not reset the connection) although this is not recommended since allowing asymmetrical routes may let traffic from the WAN go directly to the LAN without passing through the Zyxel Device. A better solution is to use virtual interfaces to put the Zyxel Device and the backup gateway on separate subnets. See [Asymmetrical Routes on page 236](#) and the chapter about interfaces for more information.

I cannot set up an IPSec VPN tunnel to another device.

If the IPSec tunnel does not build properly, the problem is likely a configuration error at one of the IPSec routers. Log into both Zyxel IPSec routers and check the settings in each field methodically and slowly. Make sure both the Zyxel Device and remote IPSec router have the same security settings for the VPN tunnel. It may help to display the settings for both routers side-by-side.

Here are some general suggestions. See also [IPSec VPN](#).

- The system log can often help to identify a configuration problem.
- If you enable NAT traversal, the remote IPSec device must also have NAT traversal enabled.
- The Zyxel Device and remote IPSec router must use the same authentication method to establish the IKE SA.
- Both routers must use the same negotiation mode.
- Both routers must use the same encryption algorithm, authentication algorithm, and DH key group.
- When using pre-shared keys, the Zyxel Device and the remote IPSec router must use the same pre-shared key.
- The Zyxel Device's local and peer ID type and content must match the remote IPSec router's peer and local ID type and content, respectively.
- The Zyxel Device and remote IPSec router must use the same active protocol.
- The Zyxel Device and remote IPSec router must use the same encapsulation.
- The Zyxel Device and remote IPSec router must use the same SPI.
- If the sites are/were previously connected using a leased line or ISDN router, physically disconnect these devices from the network before testing your new VPN connection. The old route may have been learned by RIP and would take priority over the new VPN connection.
- To test whether or not a tunnel is working, ping from a computer at one site to a computer at the other.
Before doing so, ensure that both computers have Internet access (via the IPSec routers).
- It is also helpful to have a way to look at the packets that are being sent and received by the Zyxel Device and remote IPSec router (for example, by using a packet sniffer).

Check the configuration for the following Zyxel Device features.

- The Zyxel Device does not put IPSec SAs in the routing table. You must create a policy route for each VPN tunnel.
- Make sure the To-Zyxel Device security policies allow IPSec VPN traffic to the Zyxel Device. IKE uses UDP port 500, AH uses IP protocol 51, and ESP uses IP protocol 50.
- The Zyxel Device supports UDP port 500 and UDP port 4500 for NAT traversal. If you enable this, make sure the To-Zyxel Device security policies allow UDP port 4500 too.
- Make sure regular security policies allow traffic between the VPN tunnel and the rest of the network. Regular security policies check packets the Zyxel Device sends before the Zyxel Device encrypts them and check packets the Zyxel Device receives after the Zyxel Device decrypts them. This depends on the zone to which you assign the VPN tunnel and the zone from which and to which traffic may be routed.
- If you set up a VPN tunnel across the Internet, make sure your ISP supports AH or ESP (whichever you are using).
- If you have the Zyxel Device and remote IPSec router use certificates to authenticate each other, You must set up the certificates for the Zyxel Device and remote IPSec router first and make sure they trust each other's certificates. If the Zyxel Device's certificate is self-signed, import it into the remote IPSec router. If it is signed by a CA, make sure the remote IPSec router trusts that CA. The Zyxel Device uses one of its **Trusted Certificates** to authenticate the remote IPSec router's certificate. The trusted certificate can be the remote IPSec router's self-signed certificate or that of a trusted CA that signed the remote IPSec router's certificate.
- Multiple SAs connecting through a secure gateway must have the same negotiation mode.

The VPN connection is up but VPN traffic cannot be transmitted through the VPN tunnel.

If you have the **VPN > IPSec VPN > VPN Connection** screen's **Use Policy Route to control dynamic IPSec rules option** enabled, check the routing policies to see if they are sending traffic elsewhere instead of through the VPN tunnels.

I changed the LAN IP address and can no longer access the Internet.

The Zyxel Device automatically updates address objects based on an interface's IP address, subnet, or gateway if the interface's IP address settings change. However, you need to manually edit any address objects for your LAN that are not based on the interface.

I configured application patrol to allow and manage access to a specific service but access is blocked.

If you want to use a service, make sure the security policy allows Security Service application patrol to go through the Zyxel Device.

My two-factor authentication is not working.

Check that match the specifications and limitation in the following list:

- Ext-users (authenticated by external servers) are not supported.
- You must setup Google Authenticator on their mobile device before you can successfully authenticate with the Zyxel Device.

I get a Google Authenticator verification error.

- Check that you enter the right verification code. The verification code should be 6 digits.
- You must enter the code within the time displayed in Google Authenticator.
- You've exceeded the maximum verification code failed attempts.

The schedule I configured is not being applied at the configured times.

Make sure the Zyxel Device's current date and time are correct.

I cannot get a certificate to import into the Zyxel Device.

- 1 For **My Certificates**, you can import a certificate that matches a corresponding certification request that was generated by the Zyxel Device. You can also import a certificate in PKCS#12 format, including the certificate's public and private keys.
- 2 You must remove any spaces from the certificate's filename before you can import the certificate.
- 3 Any certificate that you want to import has to be in one of these file formats:
 - Binary X.509: This is an ITU-T recommendation that defines the formats for X.509 certificates.
 - PEM (Base-64) encoded X.509: This Privacy Enhanced Mail format uses lowercase letters, uppercase letters and numerals to convert a binary X.509 certificate into a printable form.
 - Binary PKCS#7: This is a standard that defines the general syntax for data (including digital signatures) that may be encrypted. A PKCS #7 file is used to transfer a public key certificate. The private key is not included. The Zyxel Device currently allows the importation of a PKS#7 file that contains a single certificate.
 - PEM (Base-64) encoded PKCS#7: This Privacy Enhanced Mail (PEM) format uses lowercase letters, uppercase letters and numerals to convert a binary PKCS#7 certificate into a printable form.
 - Binary PKCS#12: This is a format for transferring public key and private key certificates. The private key in a PKCS #12 file is within a password-encrypted envelope. The file's password is not connected to your certificate's public or private passwords. Exporting a PKCS #12 file creates this and you must provide it to decrypt the contents when you import the file into the Zyxel Device.

Note: Be careful not to convert a binary file to text during the transfer process. It is easy for this to occur since many programs use text files by default.

I cannot access the Zyxel Device from a computer connected to the Internet.

Check the service control rules and to-Zyxel Device security policies.

The Zyxel Device's traffic throughput rate decreased after I started collecting traffic statistics.

Data collection may decrease the Zyxel Device's traffic throughput rate.

I can only see newer logs. Older logs are missing.

When a log reaches the maximum number of log messages, new log messages automatically overwrite existing log messages, starting with the oldest existing log message first.

I cannot get the firmware uploaded using the commands.

The Web Configurator is the recommended method for uploading firmware. You only need to use the command line interface if you need to recover the firmware. See the CLI Reference Guide for how to determine if you need to recover the firmware and how to recover it.

My packet capture captured less than I wanted or failed.

The packet capture screen's **File Size** sets a maximum size limit for the total combined size of all the capture files on the Zyxel Device, including any existing capture files and any new capture files you generate. If you have existing capture files you may need to set this size larger or delete existing capture files.

The Zyxel Device stops the capture and generates the capture file when either the capture files reach the **File Size** or the time period specified in the **Duration** field expires.

My earlier packet capture files are missing.

New capture files overwrite existing files of the same name. Change the **File Suffix** field's setting to avoid this.

[My Zyxel Device CPU usage is too high. I see an alert log that says "abnormal TCP flag attack detected".](#)

Your FTP server is in active mode. It is sending too much traffic to the Zyxel Device. Set your FTP server to passive mode.

[I cannot apply a configuration file.](#)

The configuration file you upload to the Zyxel Device must meet the following requirements:

- The configuration file size cannot be 0.
- The configuration file must be a text file, a JSON file or a XML file.
- The model name in the configuration file must be the same as the Zyxel Device model you're uploading to.
- Use **Test** to check the configuration file for errors before applying it to the Zyxel Device.

[My Zyxel Device cannot assign correct IP addresses to DHCP clients in my LAN and DMZ.](#)

Make sure your Zyxel Device is the only device with DHCP server enabled in your network.

[The clients' information I collected using Device Insight is not correct.](#)

Make sure your clients are in the same IP subnet in the LAN/VLAN/DMZ networks behind the Zyxel Device. Information from clients that are in different IP subnets in the LAN/VLAN/DMZ networks might not be collected correctly.

To report on clients that are wrongly identified, go to **Network Status > Device Insight > Feedback**.

[I cannot remove a client in **Network Status > Device Insight**.](#)

Clients that are blocked cannot be removed. Please make sure to unblock the client you want to remove first.

[My USB storage device is not compatible with the Zyxel Device.](#)

The Zyxel Device supports USB file systems FAT16, FAT32, EXT3, and EXT4. To change the file system of your USB storage device by formatting it, follow these steps:

- 1 Insert your USB storage device into the computer. Be sure to back up your files before formatting your USB storage device.
- 2 Open File Explorer, right-click on the USB storage device and select **Format**.
- 3 In the **Format** window, select the desired file system:

FAT16 supports Windows, macOS, and Linux. Can store files up to 2 GB.

FAT32 supports Windows, macOS, and Linux. Can store files up to 4 GB.

EXT3 supports Linux. Can store files up to 2 TB.

EXT4 supports Linux. Can store files up to 16 TB.
- 4 Click **Start** to begin the formatting process.

32.1 Reserved System Ports

The Zyxel Device reserves the following system ports.

Note: You cannot change a service port to a reserved system port.

Table 260 Reserved System Ports

TCP PORTS	UDP PORTS
53	53
179	67
830	68
953	500
2601	546
2602	547
2603	1812
2604	1813
2605	3799
2616	4500
5432	5246
7681	5247
7682	18121

32.2 Resetting the Zyxel Device

If you cannot access the Zyxel Device by any method, try restarting it by turning the power off and then on again. If you still cannot access the Zyxel Device by any method or you forget the administrator password(s), you will need to reset the Zyxel Device to its factory-default settings.

Note: All configuration files, including those you saved on the Zyxel Device, will be deleted.

Use the following procedure to reset the Zyxel Device to its factory-default settings. This overwrites the settings in the startup-config.conf file with the settings in the system-default.conf file. It is recommended you regularly save configuration changes to your computer.

Note: This procedure removes the current configuration.

Using the RESET Button

- 1 Make sure the **PWR/SYS** LED is on and not blinking.
- 2 Press the **RESET** button and hold it until the **PWR/SYS** LED begins to blink. (This usually takes about 7 seconds.)
- 3 Release the **RESET** button, and wait for the Zyxel Device to restart.

You should be able to access the Zyxel Device using the default settings.

Using CLI

If the **RESET** button is not working, use a terminal emulation program to reset your Zyxel Device:

- 1 Connect the console port of Zyxel Device to your computer using a console cable.
- 2 Open a Terminal Emulation program, such as Tera Term. Click **Setup > Serial port**, set the **Speed** to **115200**, and click **New setting** to save the changes.
- 3 Press the **REBOOT** button and hold it until the **PWR/SYS** LED begins to blink. (This usually takes about 5 seconds.)
- 4 When the following text appears in the terminal emulation program, press any key within 3 seconds to enter debug mode.

```
BootModule Version: V1.1.5 Oct 11 2024 02:52:20
DRAM: Size = 8192 Mbytes

Press any key to enter debug mode within 3 seconds.
```

- 5 You will see `Enter Debug mode` in the terminal emulation program, indicating the Zyxel Device is now in debug mode. Type `atkz -b` and press **Enter** to reset the Zyxel Device to the factory defaults.
- 6 Type `atgo` and press **Enter** to restart the Zyxel Device. All configurations on the Zyxel Device are now reset to the factory defaults.

```
USG FLEX 500H> atkz -b
-b
OK

USG FLEX 500H> atgo
Booting...
RAM test ..... done!
```

32.3 Restarting the Zyxel Device

You may want to restart the Zyxel Device when experiencing network connectivity issues. If you want to use the standby firmware as the running firmware, then select the standby firmware and restart.

Note: When you restart the Zyxel Device, current configurations saved will not be removed.

Note: If **startup-config.conf** has an error, the Zyxel Device may restart with an older configuration file or the factory default configuration file with all your configurations lost. Use **Test** in **Maintenance > Firmware/File Manager > Configuration** to make sure that **startup-config.conf** does not have an error. See [Section 28.1.3 on page 483](#) for details on which configuration files are used at start-up.

Use one of the following procedures to restart the Zyxel Device.

Using the REBOOT Button

Use a pin to press and hold the **REBOOT** button on the Zyxel Device until the **PWR/SYS** LED starts blinking.

Using the Web Configurator

Go to the **Maintenance > Reboot/Shutdown** screen and click the **Reboot** button to restart the Zyxel Device.

Using CLI

Use a terminal emulation program, such as Tera Term, to restart your Zyxel Device.

- 1 Connect the console port of Zyxel Device to your computer using a console cable.
- 2 Open a terminal emulation program. Click **Setup > Serial port**, set the **Speed** to **115200**, and click **New setting** to save the changes.
- 3 Log in first. Type the command `copy running startup` to save the current configurations as the startup configurations.
- 4 Type `cmd reboot force` and press **Enter** to restart the Zyxel Device.

32.4 Getting More Troubleshooting Help

Go to support.zyxel.com to find other information on the Zyxel Device.



APPENDIX A

Customer Support

In the event of problems that cannot be solved by using this manual, you should contact your vendor. If you cannot contact your vendor, then contact a ZyXEL office for the region in which you bought the device.

For ZyXEL Communication offices, see <https://service-provider.zyxel.com/global/en/contact-us> for the latest information.

For ZyXEL Network offices, see <https://www.zyxel.com/index.shtml> for the latest information.

Please have the following information ready when you contact an office.

Required Information

- Product model and serial number.
- Warranty Information.
- Date that you received your device.
- Brief description of the problem and the steps you took to solve it.

Corporate Headquarters (Worldwide)

Taiwan

- ZyXEL Communications (Taiwan) Co., Ltd.
- <https://www.zyxel.com>

Asia

China

- ZyXEL Communications Corporation–China Office
- <https://www.zyxel.com/cn/sc>

India

- ZyXEL Communications Corporation–India Office
- <https://www.zyxel.com/in/en-in>

Kazakhstan

- ZyXEL Kazakhstan
- <https://www.zyxel.com/ru/ru>

Korea

- ZyXEL Korea Co., Ltd.
- <http://www.zyxel.kr/>

Malaysia

- ZyXEL Communications Corp.
- <https://www.zyxel.com/global/en>

Philippines

- ZyXEL Communications Corp.
- <https://www.zyxel.com/global/en>

Singapore

- ZyXEL Communications Corp.
- <https://www.zyxel.com/global/en>

Taiwan

- ZyXEL Communications (Taiwan) Co., Ltd.
- <https://www.zyxel.com/tw/zh>

Thailand

- ZyXEL Thailand Co., Ltd.
- <https://www.zyxel.com/th/th>

Vietnam

- ZyXEL Communications Corporation–Vietnam Office
- <https://www.zyxel.com/vn/vi>

Europe

Belarus

- ZyXEL Communications Corp.
- <https://www.zyxel.com/ru/ru>

Belgium (Netherlands)

- ZyXEL Benelux
- <https://www.zyxel.com/nl/nl>
- <https://www.zyxel.com/fr/fr>

Bulgaria

- ZyXEL Bulgaria

- <https://www.zyxel.com/bg/bg>

Czech Republic

- ZyXEL Communications Czech s.r.o.
- <https://www.zyxel.com/cz/cs>

Denmark

- ZyXEL Communications A/S
- <https://www.zyxel.com/dk/da>

Finland

- ZyXEL Communications
- <https://www.zyxel.com/fi/fi>

France

- ZyXEL France
- <https://www.zyxel.com/fr/fr>

Germany

- ZyXEL Deutschland GmbH.
- <https://www.zyxel.com/de/de>

Hungary

- ZyXEL Hungary & SEE
- <https://www.zyxel.com/hu/hu>

Italy

- ZyXEL Communications Italy S.r.l.
- <https://www.zyxel.com/it/it>

Norway

- ZyXEL Communications A/S
- <https://www.zyxel.com/no/no>

Poland

- ZyXEL Communications Poland
- <https://www.zyxel.com/pl/pl>

Romania

- ZyXEL Romania
- <https://www.zyxel.com/ro/ro>

Russian Federation

- ZyXEL Communications Corp.
- <https://www.zyxel.com/ru/ru>

Slovakia

- ZyXEL Slovakia
- <https://www.zyxel.com/sk/sk>

Spain

- ZyXEL Iberia
- <https://www.zyxel.com/es/es>

Sweden

- ZyXEL Communications A/S
- <https://www.zyxel.com/se/sv>

Switzerland

- Studerus AG
- <https://www.zyxel.com/ch/de-ch>
- <https://www.zyxel.com/fr/fr>

Turkey

- ZyXEL Turkey A.S.
- <https://www.zyxel.com/tr/tr>

UK

- ZyXEL Communications UK Ltd.
- <https://www.zyxel.com/uk/en-gb>

Ukraine

- ZyXEL Ukraine
- <https://www.zyxel.com/ua/uk-ua>

South America

Argentina

- ZyXEL Communications Corp.
- <https://www.zyxel.com/co/es-co>

Brazil

- ZyXEL Communications Brasil Ltda.

- <https://www.zyxel.com/br/pt>

Colombia

- ZyXEL Communications Corp.
- <https://www.zyxel.com/co/es-co>

Ecuador

- ZyXEL Communications Corp.
- <https://www.zyxel.com/co/es-co>

South America

- ZyXEL Communications Corp.
- <https://www.zyxel.com/co/es-co>

Middle East

Israel

- ZyXEL Communications Corp.
- <https://il.zyxel.com>

North America

USA

- ZyXEL Communications, Inc. – North America Headquarters
- <https://www.zyxel.com/us/en-us>

APPENDIX B

Product Features

Please refer to the product datasheet for the latest product features.

VERSION	1.31	1.31	1.31	1.31
MODEL NAME	USG FLEX 50H	USG FLEX 50HP	USG FLEX 100H	USG FLEX 100HP
# Of MAC	5	5	8	8
Interface				
VLAN	8	8	16	16
Virtual (Alias)	4 per interface	4 per interface	4 per interface	4 per interface
PPP Interface Number	4	4	8	8
Bridge	2	2	4	4
Routing				
Static Route Rules	64	64	64	64
Policy Route Rules	100	100	100	100
Reserved Sessions for Managed Devices	500	500	500	500
Trunk				
Max. Trunk Number (System Default)	1	1	1	1
Max. Trunk Number (User Define)	4	4	4	4
Max. Member Number Per Trunk	12	12	12	12
Sessions				
Max. TCP Concurrent Sessions (Forwarding, NAT/Firewall)	100,000	100,000	300,000	300,000
Max. UTM TCP Concurrent Sessions (CF, URL Threat Filter)	60,000	60,000	200,000	200,000
Session Rate	6,000	6,000	8,000	8,000
NAT				
Max. Virtual Server Number	64	64	64	64
Firewall (Secure Policy)				
Max Firewall ACL Rule Number = Secure Policy Number	500	500	500	500
Max Session Limit per Host Rules	100	100	100	100
DoS Prevention				
Max. DoS Prevention Profile Number	32	32	32	32
Max. DoS Prevention Rule Number	20	20	20	20
Source IP Spoofing Prevention				
Max. Interface	15	15	28	28
Max. Trusted IP/MAC Pairs	50	50	50	50
Max. Trusted IP	64	64	64	64
User Profile				
Max. Local User	64	64	64	64
Max. Admin User	5	5	5	5
Max. User Group	16	16	16	16
Max. User In One User Group	64	64	64	64
Max. Concurrent Device Login	64	64	64	64
On-Cloud Max. Concurrent Device Login	64	64	64	64
Max. Device Insight Entry	192	192	192	192
HTTPd				
Max. HTTPd Number	2	2	2	2
Objects				
Address Object	300	300	300	300
Address Group	25	25	50	50

Appendix B Product Features

VERSION	1.31	1.31	1.31	1.31
MODEL NAME	USG FLEX 50H	USG FLEX 50HP	USG FLEX 100H	USG FLEX 100HP
Max. Address Object In One Group	64	64	128	128
Service Object	200	200	200	200
Service Group	50	50	50	50
Max. Service Object In One Group	64	64	64	64
Schedule Object	32	32	32	32
Schedule Group	16	16	16	16
Max. Schedule Object In One Group	24	24	24	24
Application Object	500	500	500	500
Max. LDAP Server Object #	4	4	4	4
Max. RADIUS Server Object #	4	4	4	4
Max. AD Server Object #	4	4	4	4
VPN				
Max. VTI / VPN Tunnels Number	20	50	50	50
Max. Remote Access VPN Tunnel Number	10	25	25	25
SSL VPN				
Max. SSL VPN Connections	15	25	25	25
Max. SSL VPN Network List	8	8	8	8
SSL VPN Max. Policy	32	32	32	32
Certificate				
Certificate Buffer Size	1024K	1024K	1024K	1024K
Built-In Service				
A Record	32	32	64	64
CNAME Record	8	8	8	8
NS Record (DNS Domain Zone Forward)	8	8	8	8
MX Record	4	4	8	8
Max. DHCP Network Pool (vlan+brg+ethernet)	15	15	28	28
Max. DHCP Host Pool (Static DHCP)	64	64	128	128
Max. DHCP User Defined (Custom) Extended Options (per Pool Server-Global)	5	5	5	5
Maximum DHCP options (pre-defined + User defined) (per pool)	15	15	15	15
Max. DDNS Profiles	10	10	10	10
DHCP Relay	2 per interface	2 per interface	2 per interface	2 per interface
Max. DHCP Relay Server	4	4	4	4
Max. DHCP Relay Interface per DHCP Relay Server	24	24	24	24
USB Storage				
Device Number	1	1	1	1
Centralized Log				
Log Entries	512	512	1,024	1,024
Debug Log Entries	1024	1024	1,024	1,024
Admin E-Mail Address	2	2	2	2
Syslog Server	4	4	4	4
BWM				
Max. BWM Rule	128	128	128	128
SIP ALG				
Maximum SIP concurrent call	50	50	50	50
Maximum SIP Signaling Port	8	8	8	8
Application Patrol				
Max. App Patrol Profile Number	32	32	32	32
Max. Nebula App Patrol Profile Number (Org-wide)	20	20	20	20
IPS				
Max. Custom Signatures	32	32	32	32
SSL Inspection				
Max. SSL Inspection Profile	8	8	8	8
Max. Exclude List	256	256	256	256
Content Filtering				
Max. Content Filtering Profile Number	16	16	16	16

Appendix B Product Features

VERSION	1.31	1.31	1.31	1.31
MODEL NAME	USG FLEX 50H	USG FLEX 50HP	USG FLEX 100H	USG FLEX 100HP
Max. Nebula Content Filtering Profile Number (Org-wide)	16	16	16	16
Forbidden Domain Entry Number	256 per profile	256 per profile	256 per profile	256 per profile
Trusted Domain Entry Number	256 per profile	256 per profile	256 per profile	256 per profile
Keyword Blocking Number	128 per profile	128 per profile	128 per profile	128 per profile
Nebula Content Filtering Allow/Block Website Number (Org-wide)	100	100	100	100
URL Threat Filter				
Max. Statistic Number	1024	1024	1024	1024
Max. Allow List Rule	256	256	256	256
Max. Block List Rule	256	256	256	256
Max. Nebula Allow / Block List Rule (Org-wide)	100	100	100	100
IP Reputation				
Max. Statistic Number	1024	1024	1024	1024
Max. Allow List Rule	256	256	256	256
Max. Block List Rule	256	256	256	256
Max. Nebula Allow / Block List Rule (Org-wide)	100	100	100	100
DNS Threat Filter				
Max. Statistic Number	1024	1024	1024	1024
Max. Allow List Rule	256	256	256	256
Max. Block List Rule	256	256	256	256
Max. Nebula Allow / Block List Rule (Org-wide)	100	100	100	100
External Block List				
Max. External Block List DB Number	4	4	4	4
IP Exception				
Max. IP Exception Number	64	64	64	64
Anti-Malware				
Max. Statistic Number	512	512	1024	1024
Max. Allow List Rule	512	512	512	512
Max. Block List Rule	512	512	512	512
Max. Nebula Allow / Block List Rule (Org-wide)	100	100	100	100
Sandboxing				
Support protocol	HTTP/SMTP/POP3/FTP	HTTP/SMTP/POP3/FTP	HTTP/SMTP/POP3/FTP	HTTP/SMTP/POP3/FTP
Concurrent File Collect Capability	64	64	64	64
Upload File Size	Up to 10MB per file	Up to 10MB per file	Up to 10MB per file	Up to 10MB per file

VERSION	1.31	1.31	1.31	1.31
MODEL NAME	USG FLEX 200H	USG FLEX 200HP	USG FLEX 500H	USG FLEX 700H
# Of MAC	8	8	12	14
Interface				
VLAN	32	32	64	128
Virtual (Alias)	4 per interface	4 per interface	4 per interface	4 per interface
PPP Interface Number	8	8	12	14
Bridge	4	4	6	7
Routing				
Static Route Rules	128	128	300	512
Policy Route Rules	100	100	300	500
Reserved Sessions for Managed Devices	500	500	500	500
Trunk				
Max. Trunk Number (System Default)	1	1	1	1
Max. Trunk Number (User Define)	4	4	8	8
Max. Member Number Per Trunk	12	12	24	40
Sessions				
Max. TCP Concurrent Sessions (Forwarding, NAT/Firewall)	600,000	600,000	1,000,000	2,000,000

Appendix B Product Features

VERSION	1.31	1.31	1.31	1.31
MODEL NAME	USG FLEX 200H	USG FLEX 200HP	USG FLEX 500H	USG FLEX 700H
Max. UTM TCP Concurrent Sessions (CF, URL Threat Filter)	400,000	400,000	800,000	1,600,000
Session Rate	12,000	12,000	20,000	40,000
NAT				
Max. Virtual Server Number	128	128	256	512
Firewall (Secure Policy)				
Max Firewall ACL Rule Number = Secure Policy Number	2,000	2,000	5,000	10,000
Max Session Limit per Host Rules	100	100	100	100
DoS Prevention				
Max. DoS Prevention Profile Number	32	32	32	32
Max. DoS Prevention Rule Number	40	40	64	128
Source IP Spoofing Prevention				
Max. Interface	44	44	82	147
Max. Trusted IP/MAC Pairs	100	100	200	200
Max. Trusted IP	64	64	64	64
User Profile				
Max. Local User	128	128	256	512
Max. Admin User	5	5	5	10
Max. User Group	32	32	64	128
Max. User In One User Group	128	128	256	512
Max. Concurrent Device Login	200	200	500	2,000
On-Cloud Max. Concurrent Device Login	200	200	500	2,000
Max. Device Insight Entry	600	600	900	12,000
HTTPd				
Max. HTTPd Number	2	2	2	2
Objects				
Address Object	300	300	500	1,000
Address Group	50	50	200	400
Max. Address Object In One Group	128	128	128	256
Service Object	500	500	1,000	1,000
Service Group	100	100	200	200
Max. Service Object In One Group	128	128	128	256
Schedule Object	32	32	32	32
Schedule Group	16	16	16	16
Max. Schedule Object In One Group	24	24	24	24
Application Object	500	500	1,000	1,000
Max. LDAP Server Object #	4	4	8	8
Max. RADIUS Server Object #	4	4	8	8
Max. AD Server Object #	4	4	8	8
VPN				
Max. VTI / VPN Tunnels Number	100	100	300	1,000
Max. Remote Access VPN Tunnel Number	50	50	150	500
SSL VPN				
Max. SSL VPN Connections	50	50	150	500
Max. SSL VPN Network List	8	8	8	8
SSL VPN Max. Policy	32	32	64	128
Certificate				
Certificate Buffer Size	1024K	1024K	1024K	1024K
Built-In Service				
A Record	64	64	128	128
CNAME Record	8	8	8	8
NS Record (DNS Domain Zone Forward)	16	16	16	16
MX Record	8	8	8	8
Max. DHCP Network Pool (vlan+brg+ethernet)	44	44	82	147
Max. DHCP Host Pool (Static DHCP)	256	256	512	1,024
Max. DHCP User Defined (Custom) Extended Options (per Pool Server-Global)	5	5	5	5

Appendix B Product Features

VERSION	1.31	1.31	1.31	1.31
MODEL NAME	USG FLEX 200H	USG FLEX 200HP	USG FLEX 500H	USG FLEX 700H
Maximum DHCP options (pre-defined + User defined) (per pool)	15	15	15	15
Max. DDNS Profiles	10	10	10	10
DHCP Relay	2 per interface	2 per interface	2 per interface	2 per interface
Max. DHCP Relay Server	4	4	4	4
Max. DHCP Relay Interface per DHCP Relay Server	40	40	76	142
USB Storage				
Device Number	1	1	1	1
Centralized Log				
Log Entries	2,048	2,048	2,048	2,048
Debug Log Entries	1,024	1,024	1,024	1,024
Admin E-Mail Address	2	2	2	2
Syslog Server	4	4	4	4
BWM				
Max. BWM Rule	128	128	128	256
SIP ALG				
Maximum SIP concurrent call	100	100	100	200
Maximum SIP Signaling Port	8	8	8	8
Application Patrol				
Max. App Patrol Profile Number	32	32	64	96
Max. Nebula App Patrol Profile Number (Org-wide)	20	20	20	20
SSL Inspection				
Max. SSL Inspection Profile	8	8	16	16
Max. Exclude List	256	256	256	256
Content Filtering				
Max. Content Filtering Profile Number	16	16	32	32
Max. Nebula Content Filtering Profile Number (Org-wide)	16	16	16	16
Forbidden Domain Entry Number	256 per profile	256 per profile	512 per profile	512 per profile
Trusted Domain Entry Number	256 per profile	256 per profile	512 per profile	512 per profile
Keyword Blocking Number	128 per profile	128 per profile	256 per profile	256 per profile
Nebula Content Filtering Allow/Block Website Number (Org-wide)	100	100	100	100
URL Threat Filter				
Max. Statistic Number	1024	1024	1024	1024
Max. Allow List Rule	256	256	256	256
Max. Block List Rule	256	256	256	256
Max. Nebula Allow / Block List Rule (Org-wide)	100	100	100	100
IP Reputation				
Max. Statistic Number	1024	1024	1024	1024
Max. Allow List Rule	256	256	256	256
Max. Block List Rule	256	256	256	256
DNS Threat Filter				
Max. Statistic Number	1024	1024	1024	1024
Max. Allow List Rule	256	256	256	256
Max. Block List Rule	256	256	256	256
Max. Nebula Allow / Block List Rule (Org-wide)	100	100	100	100
External Block List				
Max. External Block List DB Number	4	4	4	4
IP Exception				
Max. IP Exception Number	64	64	64	64
Anti-Malware				
Max. Statistic Number	1024	1024	1024	1024
Max. Allow List Rule	512	512	512	512
Max. Block List Rule	512	512	512	512
Max. Nebula Allow / Block List Rule (Org-wide)	100	100	100	100

VERSION	1.31	1.31	1.31	1.31
MODEL NAME	USG FLEX 200H	USG FLEX 200HP	USG FLEX 500H	USG FLEX 700H
Sandboxing				
Support protocol	HTTP/SMTP/POP3/FTP	HTTP/SMTP/POP3/FTP	HTTP/SMTP/POP3/FTP	HTTP/SMTP/POP3/FTP
Concurrent File Collect Capability	64	64	64	64
Upload File Size	Up to 10MB per file	Up to 10MB per file	Up to 10MB per file	Up to 10MB per file

APPENDIX C

Legal Information

Copyright

Copyright © 2025 by Zyxel and/or its affiliates

The contents of this publication may not be reproduced in any part or as a whole, transcribed, stored in a retrieval system, translated into any language, or transmitted in any form or by any means, electronic, mechanical, magnetic, optical, chemical, photocopying, manual, or otherwise, without the prior written permission of Zyxel and/or its affiliates.

Published by Zyxel and/or its affiliates. All rights reserved.

Disclaimer

Zyxel does not assume any liability arising out of the application or use of any products, or software described herein. Neither does it convey any license under its patent rights nor the patent rights of others. Zyxel further reserves the right to make changes in any products described herein without notice. This publication is subject to change without notice.

Regulatory Notice and Statement (Class B)

Model List: USG FLEX 50H, USG FLEX 50HP, USG FLEX 100H, USG FLEX 100HP, USGFLEX 200H, USG FLEX 200HP

United States of America



The following information applies if you use the product within USA area.

FCC EMC Statement

- The device complies with Part 15 of the FCC Rules. Operation is subject to the following two conditions:
 - (1) This device may not cause harmful interference, and
 - (2) This device must accept any interference received, including interference that may cause undesired operation.
- Changes or modifications not expressly approved by the party responsible for compliance could void the user's authority to operate the device.
- This equipment has been tested and found to comply with the limits for a Class B digital device, pursuant to Part 15 of the FCC Rules. These limits are designed to provide reasonable protection against harmful interference in a residential installation.
- This equipment generates, uses, and can radiate radio frequency energy and, if not installed and used in accordance with the instructions, may cause harmful interference to radio communications. However, there is no guarantee that interference will not occur in a particular installation.
- If this equipment does cause harmful interference to radio or television reception, which can be determined by turning the equipment off and on, the user is encouraged to try to correct the interference by one or more of the following measures:
 - Reorient or relocate the receiving antenna
 - Increase the separation between the equipment and receiver
 - Connect the equipment into an outlet on a circuit different from that to which the receiver is connected
 - Consult the dealer or an experienced radio/TV technician for assistance

Canada

The following information applies if you use the product within Canada area

Innovation, Science and Economic Development Canada ICES statement

CAN ICES-003 (B)/NMB-003(B)

Europe and the United Kingdom



The following information applies if you use the product within the European Union or United Kingdom.

List of National Codes

COUNTRY	ISO 3166 2 LETTER CODE	COUNTRY	ISO 3166 2 LETTER CODE
Austria	AT	Liechtenstein	LI
Belgium	BE	Lithuania	LT
Bulgaria	BG	Luxembourg	LU
Croatia	HR	Malta	MT
Cyprus	CY	Netherlands	NL
Czech Republic	CZ	Norway	NO
Denmark	DK	Poland	PL
Estonia	EE	Portugal	PT
Finland	FI	Romania	RO
France	FR	Serbia	RS
Germany	DE	Slovakia	SK
Greece	GR	Slovenia	SI
Hungary	HU	Spain	ES
Iceland	IS	Sweden	SE
Ireland	IE	Switzerland	CH
Italy	IT	Turkey	TR
Latvia	LV	United Kingdom	GB

Safety Warnings

- Do not put the device in a place that is humid, dusty, has extreme temperatures, or that blocks the device ventilation slots. These conditions may harm your device.
- Please refer to the device back label, datasheet, box specifications or catalog information for power rating of the device and operating temperature.
- There is a remote risk of electric shock from lightning: (1) Do not use the device outside, and make sure all the connections are indoors. (2) Do not install or service this device during a thunderstorm.
- Do not expose your device to dampness, dust or corrosive liquids.
- Do not store things on the device.
- Do not obstruct the device ventilation slots as insufficient airflow may harm your device. For example, do not place the device in an enclosed space such as a box or on a very soft surface such as a bed or sofa.
- Do not install or service this device during a thunderstorm. There is a remote risk of electric shock from lightning.
- Connect ONLY suitable accessories to the device.
- Do not open the device. Opening or removing the device covers can expose you to dangerous high voltage points or other risks.
- Only qualified service personnel should service or disassemble this device. Please contact your vendor for further information.
- Make sure to connect the cables to the correct ports.
- Place connected cables carefully so that no one will step on them or stumble over them.
- Disconnect all cables from this device before servicing or disassembling.
- Do not remove the plug and connect it to a power outlet by itself; always attach the plug to the power adaptor first before connecting it to a power outlet.
- Do not allow anything to rest on the power adaptor or cord and do NOT place the product where anyone can walk on the power adaptor or cord.
- Please use the provided or designated connection cables/power cables/ adaptors. Connect the power adaptor or cord to the right supply voltage (for example, 120V AC in North America or 230V AC in Europe). If the power adaptor or cord is damaged, it might cause electrocution. Remove the damaged power adaptor or cord from the device and the power source. Do not try to repair the power adaptor or cord by yourself. Contact your local vendor to order a new one.
- CAUTION: There is a risk of explosion if you replace the device battery with an incorrect one. Dispose of used batteries according to the instructions. Dispose them at the applicable collection point for the recycling of electrical and electronic devices. For detailed information about recycling of this product, please contact your local city office, your household waste disposal service or the store where you purchased the product.
- Do not leave a battery in an extremely high temperature environment or surroundings since it can result in an explosion or the leakage of flammable liquid or gas.
- Do not subject a battery to extremely low air pressure since it may result in an explosion or the leakage of flammable liquid or gas.

- The following warning statements apply, where the disconnect device is not incorporated in the device or where the plug on the power supply cord is intended to serve as the disconnect device.
 - For a permanently connected device, a readily accessible method to disconnect the device shall be incorporated externally to the device;
 - For a pluggable device, the socket-outlet shall be installed near the device and shall be easily accessible.
- Complies with 21 CFR 1040.10 and 1040.11 except for conformance with IEC 60825-1 Ed. 3., as described in Laser Notice No. 56, dated May 8, 2019.
- Conforme à 21 CFR 1040.10 et 1040.11 sauf pour la conformité à la norme CEI 60825-1 Ed. 3., comme décrit dans la notice laser Numéro 56 du 8 mai 2019.
- Ce produit laser est un produit laser de classe 1 conforme à la norme CEI 60825-1: 2014
- CLASS 1 LASER PRODUCT & "IEC 60825-1:2014"
- CLASS 1 CONSUMER LASER PRODUCT & "EN 50689:2021"
- Caution - Use of controls or adjustments or performance of procedures other than those specified herein may result in hazardous radiation exposure.
- Attention - L'utilisation des commandes ou réglages ou l'exécution des procédures autres que celles spécifiées dans les présents exigences peuvent être la cause d'une exposition à un rayonnement dangereux)

Environment Statement

ErP (Energy-related Products)

Zyxel products put on the EU and United Kingdom markets comply with the requirement of the European Parliament and the Council published Directive 2009/125/EC and UK regulation establishing a framework for the setting of ecodesign requirements for energy-related products (recast), the so called "ErP Directive (Energy-related Products directive), as well as ecodesign requirements laid down in applicable implementation measures. Power consumption has satisfied the regulation requirements which are:

- Network standby power consumption < 8 W (watts), and/or
- Off mode power consumption < 0.5 W (watts), and/or
- Standby mode power consumption < 0.5 W (watts).

(Wireless settings, please refer to the chapter about wireless settings for more detail.)

Disposal and Recycling Information

The symbol below means that according to local regulations your product and/or its battery shall be disposed of separately from domestic waste. If this product is end of life, take it to a recycling station designated by local authorities. At the time of disposal, the separate collection of your product and/or its battery will help save natural resources and ensure that the environment is sustainable development.

Die folgende Symbol bedeutet, dass Ihr Produkt und/oder seine Batterie gemäß den örtlichen Bestimmungen getrennt vom Hausmüll entsorgt werden muss. Wenden Sie sich an eine Recyclingstation, wenn dieses Produkt das Ende seiner Lebensdauer erreicht hat. Zum Zeitpunkt der Entsorgung wird die getrennte Sammlung von Produkt und/oder seiner Batterie dazu beitragen, natürliche Ressourcen zu sparen und die Umwelt und die menschliche Gesundheit zu schützen.

El símbolo de abajo indica que según las regulaciones locales, su producto y/o su batería deberán depositarse como basura separada de la doméstica. Cuando este producto alcance el final de su vida útil, llévelo a un punto limpio. Cuando llegue el momento de desechar el producto, la recogida por separado éste y/o su batería ayudará a salvar los recursos naturales y a proteger la salud humana y medioambiental.

Le symbole ci-dessous signifie que selon les réglementations locales votre produit et/ou sa batterie doivent être éliminés séparément des ordures ménagères. Lorsque ce produit atteint sa fin de vie, amenez-le à un centre de recyclage. Au moment de la mise au rebut, la collecte séparée de votre produit et/ou de sa batterie aidera à économiser les ressources naturelles et protéger l'environnement et la santé humaine.

Il simbolo sotto significa che secondo i regolamenti locali il vostro prodotto e/o batteria deve essere smaltito separatamente dai rifiuti domestici. Quando questo prodotto raggiunge la fine della vita di servizio portarlo a una stazione di riciclaggio. Al momento dello smaltimento, la raccolta separata del vostro prodotto e/o della sua batteria aiuta a risparmiare risorse naturali e a proteggere l'ambiente e la salute umana.

Symbolen innebär att enligt lokal lagstiftning ska produkten och/eller dess batteri kastas separat från hushållsavfallet. När den här produkten når slutet av sin livslängd ska du ta den till en återvinningsstation. Vid tiden för kasseringen bidrar du till en bättre miljö och mänsklig hälsa genom att göra dig av med den på ett återvinningsställe.



台灣

安全警告 - 為了您的安全，請先閱讀以下警告及指示：





- 請勿將此產品接近水、火焰或放置在高溫的環境。
- 避免設備接觸：
 - 任何液體 - 切勿讓設備接觸水、雨水、高濕度、污水腐蝕性的液體或其他水份。
 - 灰塵及污物 - 切勿接觸灰塵、污物、沙土、食物或其他不適合的材料。
- 雷雨天氣時，不要安裝或維修此設備。有遭受電擊的風險。

- 切勿重摔或撞擊設備，並勿使用不正確的電源變壓器。
- 若接上不正確的電源變壓器會有爆炸的風險。
- 請勿隨意更換產品內的電池。
- 如果更換不正確之電池型式，會有爆炸的風險，請依製造商說明書處理使用過之電池。
- 請將廢電池丟棄在適當的電器或電子設備回收處。
- 請勿將設備解體。
- 請勿阻礙設備的散熱孔，空氣對流不足將會造成設備損害。
- 請使用隨貨提供或指定的連接線 / 電源線 / 電源變壓器，將其連接到合適的供應電壓（如：台灣供應電壓 110 伏特）。
- 假若電源變壓器或電源變壓器的纜線損壞，請從插座拔除，若您還繼續插電使用，會有觸電死亡的風險。
- 請勿試圖修理電源變壓器或電源變壓器的纜線，若有毀損，請直接聯絡您購買的店家，購買一個新的電源變壓器。
- 請勿將此設備安裝於室外，此設備僅適合放置於室內。
- 請勿隨一般垃圾丟棄。
- 請參閱產品背貼上的設備額定功率。
- 請參考產品型錄或是彩盒上的作業溫度。
- 產品沒有斷電裝置或者採用電源線的插頭視為斷電裝置的一部分，以下警語將適用：
 - 對永久連接之設備，在設備外部須安裝可觸及之斷電裝置；
 - 對插接式之設備，插座必須接近安裝之地點而且是易於觸及的。

About the Symbols

Various symbols are used in this product to ensure correct usage, to prevent danger to the user and others, and to prevent property damage. The meaning of these symbols are described below. It is important that you read these descriptions thoroughly and fully understand the contents.

Explanation of the Symbols

SYMBOL	EXPLANATION
	Alternating current (AC): AC is an electric current in which the flow of electric charge periodically reverses direction.
	Direct current (DC): DC is the unidirectional flow or movement of electric charge carriers.
	Earth; ground: A wiring terminal intended for connection of a Protective Earthing Conductor.
	Class II equipment: The method of protection against electric shock in the case of class II equipment is either double insulation or reinforced insulation.

Viewing Certifications

Go to <http://www.zyxel.com> to view this product's documentation and certifications.

Zyxel Limited Warranty

Zyxel warrants to the original end user (purchaser) that this product is free from any defects in material or workmanship for a specific period (the Warranty Period) from the date of purchase. The Warranty Period varies by region. Check with your vendor and/or the authorized Zyxel local distributor for details about the Warranty Period of this product. During the warranty period, and upon proof of purchase, should the product have indications of failure due to faulty workmanship and/or materials, Zyxel will, at its discretion, repair or replace the defective products or components without charge for either parts or labor, and to whatever extent it shall deem necessary to restore the product or components to proper operating condition. Any replacement will consist of a new or re-manufactured functionally equivalent product of equal or higher value, and will be solely at the discretion of Zyxel. This warranty shall not apply if the product has been modified, misused, tampered with, damaged by an act of God, or subjected to abnormal working conditions.

Note

Repair or replacement, as provided under this warranty, is the exclusive remedy of the purchaser. This warranty is in lieu of all other warranties, express or implied, including any implied warranty of merchantability or fitness for a particular use or purpose. Zyxel shall in no event be held liable for indirect or consequential damages of any kind to the purchaser.

To obtain the services of this warranty, contact your vendor. You may also refer to the warranty policy for the region in which you bought the device at <https://www.zyxel.com/global/en/support/warranty-information>.

Registration

Register your product online at www.zyxel.com to receive email notices of firmware upgrades and related information.

Trademarks

ZYNOS (Zyxel Network Operating System) and ZON (Zyxel One Network) are registered trademarks of Zyxel Communications, Inc. Other trademarks mentioned in this publication are used for identification purposes only and may be properties of their respective owners.

Open Source Licenses

This product may contain in part some free software distributed under GPL license terms and/or GPL like licenses.

To request the source code covered under these licenses, please go to: https://www.zyxel.com/form/gpl_oss_software_notice.shtml

Regulatory Notice and Statement (Class A)

Model List: USG FLEX 500H, USG FLEX 700H

United States of America



The following information applies if you use the product within USA area.

FCC EMC Statement

• This device complies with Part 15 of the FCC rules. Operation is subject to the following two conditions:

(1) This device may not cause harmful interference.

(2) This device must accept any interference received, including interference that may cause undesired operations.

- Changes or modifications not expressly approved by the party responsible for compliance could void the user's authority to operate the equipment.
- This equipment has been tested and found to comply with the limits for a Class A digital device, pursuant to part 15 of the FCC Rules. These limits are designed to provide reasonable protection against harmful interference when the equipment is operated in a commercial environment. This equipment generates, uses, and can radiate radio frequency energy and, if not installed and used in accordance with the instruction manual, may cause harmful interference to radio communications. Operation of this equipment in a residential area is likely to cause harmful interference in which case the user will be required to correct the interference at his own expense.

Canada

The following information applies if you use the product within Canada area

Innovation, Science and Economic Development Canada ICES statement

CAN ICES-3 (A)/NMB-3(A)

Europe and the United Kingdom



The following information applies if you use the product within the European Union or United Kingdom.

EMC statement

WARNING: This equipment is compliant with Class A of EN55032. In a residential environment this equipment may cause radio interference.

List of National Codes

COUNTRY	ISO 3166 2 LETTER CODE	COUNTRY	ISO 3166 2 LETTER CODE
Austria	AT	Liechtenstein	LI
Belgium	BE	Lithuania	LT
Bulgaria	BG	Luxembourg	LU
Croatia	HR	Malta	MT
Cyprus	CY	Netherlands	NL
Czech Republic	CZ	Norway	NO
Denmark	DK	Poland	PL
Estonia	EE	Portugal	PT
Finland	FI	Romania	RO
France	FR	Serbia	RS
Germany	DE	Slovakia	SK
Greece	GR	Slovenia	SI
Hungary	HU	Spain	ES
Iceland	IS	Sweden	SE
Ireland	IE	Switzerland	CH
Italy	IT	Turkey	TR
Latvia	LV	United Kingdom	GB

Safety Warnings

- Do not put the device in a place that is humid, dusty, has extreme temperatures, or that blocks the device ventilation slots. These conditions may harm your device.
- Please refer to the device back label, datasheet, box specifications or catalog information for power rating of the device and operating temperature.
- There is a remote risk of electric shock from lightning: (1) Do not use the device outside, and make sure all the connections are indoors. (2) Do not install or service this device during a thunderstorm.
- Do not expose your device to dampness, dust or corrosive liquids.
- Do not store things on the device.
- Do not obstruct the device ventilation slots as insufficient airflow may harm your device. For example, do not place the device in an enclosed space such as a box or on a very soft surface such as a bed or sofa.
- Do not install or service this device during a thunderstorm. There is a remote risk of electric shock from lightning.
- Connect ONLY suitable accessories to the device.
- Do not open the device. Opening or removing the device covers can expose you to dangerous high voltage points or other risks.
- Only qualified service personnel should service or disassemble this device. Please contact your vendor for further information.
- Make sure to connect the cables to the correct ports.
- Place connected cables carefully so that no one will step on them or stumble over them.
- Disconnect all cables from this device before servicing or disassembling.
- Do not remove the plug and connect it to a power outlet by itself; always attach the plug to the power adaptor first before connecting it to a power outlet.
- Do not allow anything to rest on the power adaptor or cord and do NOT place the product where anyone can walk on the power adaptor or cord.
- Please use the provided or designated connection cables/power cables/ adaptors. Connect the power adaptor or cord to the right supply voltage (for example, 120V AC in North America or 230V AC in Europe). If the power adaptor or cord is damaged, it might cause electrocution. Remove the damaged power adaptor or cord from the device and the power source. Do not try to repair the power adaptor or cord by yourself. Contact your local vendor to order a new one.
- CAUTION: There is a risk of explosion if you replace the device battery with an incorrect one. Dispose of used batteries according to the instructions. Dispose them at the applicable collection point for the recycling of electrical and electronic devices. For detailed information about recycling of this product, please contact your local city office, your household waste disposal service or the store where you purchased the product.
- Do not leave a battery in an extremely high temperature environment or surroundings since it can result in an explosion or the leakage of flammable liquid or gas.
- Do not subject a battery to extremely low air pressure since it may result in an explosion or the leakage of flammable liquid or gas.
- Use ONLY power wires of the appropriate wire gauge for your device. Connect it to a power supply of the correct voltage.
- The POE (Power over Ethernet) devices that supply or receive power and their connected Ethernet cables must all be completely indoors.
- The following warning statements apply, where the disconnect device is not incorporated in the device or where the plug on the power supply cord is intended to serve as the disconnect device.
 - For a permanently connected device, a readily accessible method to disconnect the device shall be incorporated externally to the device;
 - For a pluggable device, the socket-outlet shall be installed near the device and shall be easily accessible.
- This device must be grounded by qualified service personnel. Never defeat the ground conductor or operate the device in the absence of a suitably installed ground conductor. Contact the appropriate electrical inspection authority or an electrician if you are uncertain that suitable grounding is available. If your device has an earthing screw (frame ground), connect the screw to a ground terminal using an appropriate AWG ground wire. Do this before you make other connections. If your device has no earthing screw, but has a 3-prong power plug, make sure to connect the plug to a 3-hole earthed socket.

- When connecting or disconnecting power to hot-pluggable power supplies, if offered with your system, observe the following guidelines:
 - Install the power supply before connecting the power cable to the power supply.
 - Unplug the power cable before removing the power supply.
 - If the system has multiple sources of power, disconnect power from the system by unplugging all power cables from the power supply.
- Complies with 21 CFR 1040.10 and 1040.11 except for conformance with IEC 60825-1 Ed. 3., as described in Laser Notice No. 56, dated May 8, 2019.
- Conforme à 21 CFR 1040.10 et 1040.11 sauf pour la conformité à la norme CEI 60825-1 Ed. 3., comme décrit dans la notice laser Numéro 56 du 8 mai 2019.
- Ce produit laser est un produit laser de classe 1 conforme à la norme CEI 60825-1: 2014
- CLASS 1 LASER PRODUCT & "IEC 60825-1:2014"
- CLASS 1 CONSUMER LASER PRODUCT & "EN 50689:2021"
- Caution - Use of controls or adjustments or performance of procedures other than those specified herein may result in hazardous radiation exposure.
- Attention - L'utilisation des commandes ou réglages ou l'exécution des procédures autres que celles spécifiées dans les présents exigences peuvent être la cause d'une exposition à un rayonnement dangereux]

Environment Statement

Disposal and Recycling Information

The symbol below means that according to local regulations your product and/or its battery shall be disposed of separately from domestic waste. If this product is end of life, take it to a recycling station designated by local authorities. At the time of disposal, the separate collection of your product and/or its battery will help save natural resources and ensure that the environment is sustainable development.

Die folgende Symbol bedeutet, dass Ihr Produkt und/oder seine Batterie gemäß den örtlichen Bestimmungen getrennt vom Hausmüll entsorgt werden muss. Wenden Sie sich an eine Recyclingstation, wenn dieses Produkt das Ende seiner Lebensdauer erreicht hat. Zum Zeitpunkt der Entsorgung wird die getrennte Sammlung von Produkt und/oder seiner Batterie dazu beitragen, natürliche Ressourcen zu sparen und die Umwelt und die menschliche Gesundheit zu schützen.

El símbolo de abajo indica que según las regulaciones locales, su producto y/o su batería deberán depositarse como basura separada de la doméstica. Cuando este producto alcance el final de su vida útil, llévelo a un punto limpio. Cuando llegue el momento de desechar el producto, la recogida por separado éste y/o su batería ayudará a salvar los recursos naturales y a proteger la salud humana y medioambiental.

Le symbole ci-dessous signifie que selon les réglementations locales votre produit et/ou sa batterie doivent être éliminés séparément des ordures ménagères. Lorsque ce produit atteint sa fin de vie, amenez-le à un centre de recyclage. Au moment de la mise au rebut, la collecte séparée de votre produit et/ou de sa batterie aidera à économiser les ressources naturelles et protéger l'environnement et la santé humaine.

Il simbolo sotto significa che secondo i regolamenti locali il vostro prodotto e/o batteria deve essere smaltito separatamente dai rifiuti domestici. Quando questo prodotto raggiunge la fine della vita di servizio portarlo a una stazione di riciclaggio. Al momento dello smaltimento, la raccolta separata del vostro prodotto e/o della sua batteria aiuta a risparmiare risorse naturali e a proteggere l'ambiente e la salute umana.

Symbolen innebär att enligt lokal lagstiftning ska produkten och/eller dess batteri kastas separat från hushållsavfallet. När den här produkten når slutet av sin livslängd ska du ta den till en återvinningsstation. Vid tiden för kasseringen bidrar du till en bättre miljö och mänsklig hälsa genom att göra dig av med den på ett återvinningsställe.



台灣

警告使用者

- 這是甲類的資訊產品，在居住的環境中使用時，可能會造成射頻干擾，在這種情況下，使用者會被要求採取某些適當的對策。
- 為避免電磁干擾，本產品不應安裝或使用於住宅環境。

安全警告 – 為了您的安全，請先閱讀以下警告及指示：





- 請勿將此產品接近水、火焰或放置在高溫的環境。
- 避免設備接觸：
 - 任何液體 - 切勿讓設備接觸水、雨水、高濕度、污水腐蝕性的液體或其他水份。
 - 灰塵及污物 - 切勿接觸灰塵、污物、沙土、食物或其他不適合的材料。
- 雷雨天氣時，不要安裝或維修此設備。有遭受電擊的風險。
- 切勿重摔或撞擊設備，並勿使用不正確的電源變壓器。
- 若接上不正確的電源變壓器會有爆炸的風險。

- 請勿隨意更換產品內的電池。
- 如果更換不正確之電池型式，會有爆炸的風險，請依製造商說明書處理使用過之電池。
- 請將廢電池丟棄在適當的電器或電子設備回收處。
- 請勿將設備解體。
- 請勿阻礙設備的散熱孔，空氣對流不足將會造成設備損害。
- 請使用隨貨提供或指定的連接線 / 電源線 / 電源變壓器，將其連接到合適的供應電壓 (如：台灣供應電壓 110 伏特)。
- 假若電源變壓器或電源變壓器的纜線損壞，請從插座拔除，若您還繼續插電使用，會有觸電死亡的風險。
- 請勿試圖修理電源變壓器或電源變壓器的纜線，若有毀損，請直接聯絡您購買的店家，購買一個新的電源變壓器。
- 請勿將此設備安裝於室外，此設備僅適合放置於室內。
- 請勿隨一般垃圾丟棄。
- 請參閱產品背貼上的設備額定功率。
- 請參考產品型錄或是彩盒上的作業溫度。
- 設備必須接地，接地導線不允許被破壞或沒有適當安裝接地導線，如果不確定接地方式是否符合要求可聯繫相應的電氣檢驗機構檢驗。
- 產品沒有斷電裝置或者採用電源線的插頭視為斷電裝置的一部分，以下警語將適用：
 - 對永久連接之設備，在設備外部須安裝可觸及之斷電裝置；
 - 對插接式之設備，插座必須接近安裝之地點而且是易於觸及的。

About the Symbols

Various symbols are used in this product to ensure correct usage, to prevent danger to the user and others, and to prevent property damage. The meaning of these symbols are described below. It is important that you read these descriptions thoroughly and fully understand the contents.

Explanation of the Symbols

SYMBOL	EXPLANATION
	Alternating current (AC): AC is an electric current in which the flow of electric charge periodically reverses direction.
	Direct current (DC): DC is the unidirectional flow or movement of electric charge carriers.
	Earth; ground: A wiring terminal intended for connection of a Protective Earthing Conductor.
	Class II equipment: The method of protection against electric shock in the case of class II equipment is either double insulation or reinforced insulation.

Viewing Certifications

Go to <http://www.zyxel.com> to view this product's documentation and certifications.

Zyxel Limited Warranty

Zyxel warrants to the original end user (purchaser) that this product is free from any defects in material or workmanship for a specific period (the Warranty Period) from the date of purchase. The Warranty Period varies by region. Check with your vendor and/or the authorized Zyxel local distributor for details about the Warranty Period of this product. During the warranty period, and upon proof of purchase, should the product have indications of failure due to faulty workmanship and/or materials, Zyxel will, at its discretion, repair or replace the defective products or components without charge for either parts or labor, and to whatever extent it shall deem necessary to restore the product or components to proper operating condition. Any replacement will consist of a new or re-manufactured functionally equivalent product of equal or higher value, and will be solely at the discretion of Zyxel. This warranty shall not apply if the product has been modified, misused, tampered with, damaged by an act of God, or subjected to abnormal working conditions.

Note

Repair or replacement, as provided under this warranty, is the exclusive remedy of the purchaser. This warranty is in lieu of all other warranties, express or implied, including any implied warranty of merchantability or fitness for a particular use or purpose. Zyxel shall in no event be held liable for indirect or consequential damages of any kind to the purchaser.

To obtain the services of this warranty, contact your vendor. You may also refer to the warranty policy for the region in which you bought the device at <https://www.zyxel.com/global/en/support/warranty-information>.

Registration

Register your product online at www.zyxel.com to receive email notices of firmware upgrades and related information.

Open Source Licenses

This product may contain in part some free software distributed under GPL license terms and/or GPL like licenses.

To request the source code covered under these licenses, please go to: https://www.zyxel.com/form/gpl_oss_software_notice.shtml

Symbols

Numbers

- 1 Gbps [47](#)
- 10 Gbps [47](#)
- 100 Mbps [47](#)
- 2.5 Gbps [47](#)
- 3322 Dynamic DNS [430](#)
- 3DES [189](#)
- 5 Gbps [47](#)

A

- AAA
 - Base DN [402](#)
 - Bind DN [403](#)
 - directory structure [402](#)
 - Distinguished Name, see DN
 - DN [402](#)
 - port [410, 411](#)
- AAA server [403](#)
 - and users [390](#)
 - local user database [401](#)
 - RADIUS [401, 403, 407](#)
 - RADIUS group [405, 408, 410](#)
 - see also RADIUS
- access [23](#)
- access control attacks [362](#)
- access users [389](#)
 - multiple logins [400](#)
 - see also users [389](#)
- account
 - user [389, 401](#)
- accounting server [403](#)
- active protocol [193](#)
 - AH [193](#)
 - and encapsulation [193](#)
 - ESP [193](#)
 - active sessions [78](#)
 - AD [402, 403](#)
 - directory structure [402](#)
 - Distinguished Name, see DN
 - port [410, 411](#)
 - address groups [257](#)
 - and content filtering [294](#)
 - address objects [257](#)
 - and content filtering [294](#)
 - and NAT [160, 169](#)
 - and policy routes [159](#)
 - HOST [259](#)
 - RANGE [259](#)
 - SUBNET [259](#)
 - types of [257, 263](#)
 - address record [433](#)
 - admin users [389](#)
 - multiple logins [400](#)
 - see also users [389](#)
 - ADP [243](#)
 - false negatives [245](#)
 - false positives [245](#)
 - inline profile [245](#)
 - monitor profile [245](#)
 - Advanced Encryption Standard, see AES
 - AES [189](#)
 - AF [155](#)
 - AH [193](#)
 - and transport mode [194](#)
 - alerts
 - IDP [378](#)
 - ALG [183](#)
 - and NAT [183](#)
 - and policy routes [183](#)
 - and security policy [183](#)
 - and trunks [183](#)
 - FTP [183, 184](#)
 - H.323 [183](#)
 - see also VoIP pass through [183](#)
 - SIP [183](#)
 - Anomaly Detection and Prevention, see ADP

- Anonymizer [331, 336](#)
 - Anonymous Proxies [324](#)
 - anti-malware [342](#)
 - boot sector virus [342](#)
 - EICAR [345](#)
 - e-mail
 - virus [342](#)
 - file infector [342](#)
 - file infector virus [342](#)
 - macro virus [342](#)
 - malware life cycle [342](#)
 - malware types [342](#)
 - mutation virus [342](#)
 - packet types [342](#)
 - polymorphic virus [342](#)
 - scanner types [350](#)
 - statistics [87](#)
 - virus [342](#)
 - worm [342](#)
 - anti-virus
 - EICAR [345](#)
 - e-mail virus [342](#)
 - polymorphic virus [342](#)
 - statistics [87, 89](#)
 - troubleshooting [523, 524](#)
 - updating signatures [108, 109](#)
 - Application Layer Gateway, see ALG
 - application patrol [283](#)
 - actions [283](#)
 - and security policy [283](#)
 - classification [284](#)
 - exceptions [283](#)
 - port-less [284](#)
 - ports [284](#)
 - service ports [284](#)
 - troubleshooting [523, 527, 529](#)
 - asymmetrical routes [236](#)
 - allowing through the security policy [238](#)
 - vs virtual interfaces [236](#)
 - attacks
 - access control [362](#)
 - backdoor [362](#)
 - buffer overflow [361](#)
 - DoS/DDoS [362](#)
 - P2P [362](#)
 - scan [362](#)
 - trapdoor [362](#)
 - trojan [362](#)
 - virus [342, 362](#)
 - worm [362](#)
 - authentication
 - in IPSec [205, 207, 212](#)
 - server [403](#)
 - authentication algorithms [189](#)
 - and active protocol [189](#)
 - MD5 [190](#)
 - SHA1 [190](#)
 - Authentication Header, see AH
 - authentication method objects
 - and users [390](#)
 - authentication server [448](#)
 - Authentication, Authorization, Accounting servers, see AAA server
 - authorization server [403](#)
 - auxiliary interfaces [112](#)
- ## B
- backdoor attacks [362](#)
 - backing up configuration files [484](#)
 - bandwidth capacity
 - cable types [48](#)
 - bandwidth management [283](#)
 - maximize bandwidth usage [173](#)
 - see also application patrol [283](#)
 - Base DN [402](#)
 - Bind DN [403](#)
 - BitTorrent [362](#)
 - Blaster [366](#)
 - Botnet [325](#)
 - bridge interfaces [112, 114](#)
 - and virtual interfaces of members [114](#)
 - effect on routing table [114](#)
 - member interfaces [114](#)
 - bridges [113](#)
 - Brute Force Attack [325](#)
 - buffer overflow [361](#)
 - buffer overflow attacks [361](#)
- ## C
- CA

- and certificates [454](#)
- CA (Certificate Authority), see certificates
- cable types [48](#)
- capturing packets [499](#)
- CAT 5 cable [48](#)
- CAT 5e cable [47](#)
- CAT 6 cable [47](#)
- CAT 6a cable [47](#)
- CAT 7 cable [48](#)
- CEF (Common Event Format) [476](#)
- certificate
 - troubleshooting [530](#)
- Certificate Authority (CA)
 - see certificates
- Certificate Revocation List (CRL) [454](#)
- certificates [453](#)
 - advantages of [454](#)
 - and CA [454](#)
 - and HTTPS [417](#)
 - and IKE SA [193](#)
 - certification path [453](#), [466](#)
 - expired [453](#)
 - factory-default [454](#)
 - file formats [454](#)
 - not used for encryption [453](#)
 - revoked [453](#)
 - self-signed [454](#), [460](#)
 - serial number [461](#), [466](#)
 - thumbprint algorithms [455](#)
 - thumbprints [455](#)
 - used for authentication [453](#)
 - verifying fingerprints [454](#)
- certification requests [460](#)
- certifications
 - viewing [551](#), [555](#)
- check [535](#)
- Chrome [23](#)
- CLI [22](#)
 - Reference Guide [2](#)
- commands [22](#)
- Common Event Format (CEF) [476](#)
- computer names [117](#)
- computer virus [342](#)
 - see also virus
- configuration
 - information [496](#)
 - configuration files [483](#)
 - at restart [485](#)
 - backing up [484](#)
 - downloading [486](#)
 - editing [483](#)
 - lastgood.conf [484](#), [488](#), [490](#)
 - managing [484](#)
 - startup-config.conf [488](#), [490](#)
 - startup-config-bad.conf [484](#)
 - system-default.conf [488](#)
 - uploading [487](#)
 - use without restart [483](#)
- connection
 - troubleshooting [528](#)
- connection monitor (in SSL) [103](#)
- connectivity check [126](#), [132](#), [138](#), [142](#)
- contact information [537](#), [542](#)
- content filter
 - troubleshooting [523](#)
- content filtering [293](#), [294](#)
 - and address groups [294](#)
 - and address objects [294](#)
 - and schedules [293](#), [294](#)
 - and user groups [294](#)
 - and users [294](#)
 - by category [294](#), [295](#)
 - by keyword (in URL) [294](#)
 - by URL [294](#)
 - default policy [294](#)
 - filter list [294](#)
 - managed web pages [299](#)
 - policies [293](#), [294](#)
 - registration status [107](#)
 - URL for blocked access [297](#)
- cookies [23](#)
- copyright [548](#)
- Cross Site Scripting [325](#)
- current date/time [65](#), [416](#)
 - and schedules [277](#)
 - setting manually [416](#)
 - time server [416](#)
- current user list [103](#)
- customer support [537](#), [542](#)

D

Data Encryption Standard, see DES

date [416](#)

DDNS

- backup mail exchanger [442](#)
- mail exchanger [442](#)
- service providers [429](#)
- troubleshooting [527](#)

DDoS attacks [362](#)

default

- security policy behavior [235](#)

Denial of Service (DoS) attacks [362](#)

DES [189](#)

device access

- troubleshooting [522](#)

Device HA [421](#)

- Heartbeat [422](#)

device High Availability see Device HA [421](#)

DHCP [116](#)

- and DNS servers [116](#)
- and interfaces [116](#)
- pool [116](#)
- static DHCP [116](#)

diagnostics [496](#)

Diffie-Hellman key group [190](#)

DiffServ [155](#)

direct routes [156](#)

directory service

- file structure [402](#)

Directory Service (LDAP/AD) [401](#)

disclaimer [548](#)

distance limitation

- cable types [48](#)

Distinguished Name (DN) [402](#)

Distributed Denial of Service (DDoS) attacks [362](#)

DN [402](#)

DNS [429](#)

- address records [433](#)
- domain name forwarders [436](#)
- domain name to IP address [433](#)
- IP address to domain name [433](#)
- Mail eXchange (MX) records [435](#)
- pointer (PTR) records [433](#)

DNS Filter [322](#), [329](#), [386](#)

- Priority [329](#)

- types of queries [329](#)

DNS servers [430](#), [436](#)

- and interfaces [116](#)

Domain Name System, see DNS

DoS [324](#)

DoS (Denial of Service) attacks [362](#)

DSCP [157](#), [159](#), [510](#), [516](#)

Dynamic Host Configuration Protocol, see DHCP.

DynDNS [429](#)

DynDNS see also DDNS [429](#)

Dynu [429](#)

E

Edge [23](#)

e-Donkey [362](#)

e-mail

- daily statistics report [479](#)

e-Mule [362](#)

Encapsulating Security Payload, see ESP

encapsulation

- and active protocol [193](#)
- transport mode [193](#)
- tunnel mode [193](#)
- VPN [193](#)

encryption

- IPSec [205](#), [206](#), [212](#)
- RSA [462](#)

encryption algorithms [189](#)

- 3DES [189](#)
- AES [189](#)
- and active protocol [189](#)
- DES [189](#)

ESP [193](#), [206](#)

- and transport mode [194](#)

Ethernet interfaces [112](#)

- and routing protocols [122](#), [128](#)

Exploits [324](#)

External Block List

- DNS/URL Threat Filter [386](#)
- IP Reputation [384](#)

F

false negatives [245](#)
 false positives [245, 248, 249](#)
 FCC interference statement [552](#)
 file extensions
 configuration files [483](#)
 shell scripts [483](#)
 file manager [483](#)
 Firefox [23](#)
 firmware
 and restart [493](#)
 current version [65, 494](#)
 getting updated [493](#)
 uploading [493](#)
 firmware upload
 troubleshooting [531](#)
 FQDN [433](#)
 FTP
 ALG [183](#)
 signaling port [185](#)
 troubleshooting [527](#)
 full tunnel mode [228](#)
 Fully-Qualified Domain Name, see FQDN

G

Grace Period [19](#)
 Guide
 CLI Reference [2](#)
 Quick Start [2](#)

H

host-based intrusions [365](#)
 HTTP
 over SSL, see HTTPS
 vs HTTPS [417](#)
 HTTPS [417](#)
 and certificates [417](#)
 authenticating clients [417](#)
 vs HTTP [417](#)

HyperText Transfer Protocol over Secure Socket Layer,
 see HTTPS

I

ICMP [267](#)
 IDP [356](#)
 alerts [378](#)
 log options [249, 378](#)
 service group [363](#)
 signatures [356](#)
 statistics [86](#)
 troubleshooting [523, 525](#)
 Iframe Injection [325](#)
 IKE SA
 aggressive mode [188, 191, 192](#)
 and certificates [193](#)
 and to-ZyWALL security policy [529](#)
 authentication algorithms [189](#)
 content [191](#)
 Diffie-Hellman key group [190](#)
 encryption algorithms [189](#)
 IP address, remote IPsec router [188](#)
 IP address, Zyxel device [188](#)
 local identity [191](#)
 main mode [188, 191](#)
 NAT traversal [192](#)
 negotiation mode [188](#)
 peer identity [191](#)
 pre-shared key [190](#)
 proposal [189](#)
 see also VPN
 IM (Instant Messenger) [362](#)
 iMesh [362](#)
 inline profile [245](#)
 installation
 desktop [56](#)
 installation scenarios [56](#)
 Instant Messenger (IM) [283, 362](#)
 managing [283](#)
 interfaces [111](#)
 and DNS servers [116](#)
 and layer-3 virtualization [111](#)
 and NAT [168](#)
 and physical ports [111](#)
 and policy routes [159](#)

- and static routes [162](#)
 - and zones [111](#)
 - as DHCP relays [116](#)
 - as DHCP servers [116](#)
 - auxiliary, see also auxiliary interfaces.
 - backup, see trunks
 - bridge, see also bridge interfaces.
 - DHCP clients [115](#)
 - Ethernet, see also Ethernet interfaces.
 - gateway [115](#)
 - general characteristics [111](#)
 - IP address [115](#)
 - metric [115](#)
 - overlapping IP address and subnet mask [115](#)
 - port groups, see also port groups.
 - PPPoE/PPTP, see also PPPoE/PPTP interfaces.
 - prerequisites [113](#)
 - relationships between [113](#)
 - static DHCP [116](#)
 - subnet mask [115](#)
 - trunks, see also trunks.
 - Tunnel, see also Tunnel interfaces.
 - types [111](#)
 - virtual, see also virtual interfaces.
 - VLAN, see also VLAN interfaces.
 - WLAN, see also WLAN interfaces.
- Internet access
- troubleshooting [522, 529](#)
- Internet Control Message Protocol, see ICMP
- Internet Protocol Security, see IPSec
- Intrusion, Detection and Prevention see IDP [356](#)
- intrusions
- host [365](#)
 - network [366](#)
- IP policy routing, see policy routes
- IP protocols [266](#)
- and service objects [267](#)
 - ICMP, see ICMP
 - TCP, see TCP
 - UDP, see UDP
- IP Reputation [321](#)
- External Black List [329](#)
- IP static routes, see static routes
- IP/MAC binding [249](#)
- IPSec [187](#)
- authentication [205, 207, 212](#)
 - basic troubleshooting [528](#)
 - encryption [205, 206, 212](#)
 - ESP [206](#)
 - established in two phases [195](#)
 - local network [187](#)
 - peer [187](#)
 - remote IPSec router [187](#)
 - remote network [187](#)
 - SA see also IPSec SA [193](#)
 - see also VPN
 - tunnel encapsulation [206](#)
- IPSec SA
- active protocol [193](#)
 - and security policy [529](#)
 - and to-ZyWALL security policy [529](#)
 - authentication algorithms [189](#)
 - encapsulation [193](#)
 - encryption algorithms [189](#)
 - local policy [193](#)
 - Perfect Forward Secrecy (PFS) [194](#)
 - proposal [194](#)
 - remote policy [193](#)
 - Security Parameter Index (SPI) (manual keys) [194](#)
 - see also IPSec
 - see also VPN
 - transport mode [193](#)
 - tunnel mode [193](#)
 - when IKE SA is disconnected [193](#)
- IPSec VPN
- troubleshooting [528](#)
- ## J
- Java
- permissions [23](#)
- JavaScripts [23](#)
- ## K
- key pairs [453](#)
- ## L
- lastgood.conf [484, 488, 490](#)
- LDAP
- and users [390](#)

- Base DN [402](#)
 - Bind DN [403](#)
 - directory structure [402](#)
 - Distinguished Name, see DN
 - DN [402](#)
 - port [410, 411](#)
 - least load first load balancing [144](#)
 - LED troubleshooting [522](#)
 - level-4 inspection [284](#)
 - level-7 inspection [284](#)
 - licensing [105](#)
 - load balancing [143](#)
 - algorithms [144, 148, 149](#)
 - least load first [144](#)
 - round robin [144](#)
 - see also trunks [143](#)
 - session-oriented [144](#)
 - spillover [145](#)
 - weighted round robin [144](#)
 - local user database [401](#)
 - log
 - troubleshooting [531](#)
 - log options
 - (IDP) [249, 378](#)
 - logs
 - and security policy [241](#)
 - e-mail profiles [474](#)
 - log consolidation [476](#)
 - settings [474](#)
 - syslog servers [474](#)
 - system [474](#)
 - types of [474](#)
- ## M
- MAC address
 - and VLAN [118](#)
 - Ethernet interface [125, 130, 135](#)
 - range [64](#)
 - managed web pages [299](#)
 - management access
 - troubleshooting [531](#)
 - Management Information Base (MIB) [443, 444](#)
 - managing the device
 - using SNMP. See SNMP.
 - maximum distance
 - cable types [48](#)
 - MD5 [190](#)
 - Message Digest 5, see MD5
 - monitor [103](#)
 - sessions [78](#)
 - monitor profile
 - ADP [245](#)
 - mounting
 - rack [21, 56](#)
 - wall [58](#)
 - My Certificates, see also certificates [455](#)
 - MyDoom [366](#)
- ## N
- NAT [155, 163](#)
 - ALG, see ALG
 - and address objects [160](#)
 - and address objects (HOST) [169](#)
 - and ALG [183](#)
 - and interfaces [168](#)
 - and policy routes [154, 160](#)
 - and security policy [237](#)
 - and to-ZyWALL security policy [170](#)
 - and VPN [192](#)
 - loopback [165](#)
 - port forwarding, see NAT
 - port translation, see NAT
 - traversal [192](#)
 - NBNS [117](#)
 - NetBIOS
 - Name Server, see NBNS.
 - network access mode
 - full tunnel [228](#)
 - Network Address Translation, see NAT
 - network-based intrusions [366](#)
 - Nimda [366](#)
 - No-IP [430](#)
- ## O
- objects [229](#)
 - AAA server [403](#)
 - addresses and address groups [257](#)

- certificates [453](#)
- schedules [277](#)
- services and service groups [266](#)
- users, user groups [389, 401](#)

ommon [342](#)

OSI (Open System Interconnection) [356](#)

OSI level-4 [284](#)

OSI level-7 [284](#)

P

P Reputation

- Priority [322](#)

P2P (Peer-to-peer) [362](#)

- attacks [362](#)
- see also Peer-to-peer

packet

- inspection signatures [357](#)

packet capture [499](#)

- files [498, 502, 503](#)
- troubleshooting [531](#)

packet captures

- downloading files [498, 499](#)

Peanut Hull [430](#)

Peer-to-peer (P2P) [362](#)

- managing [283](#)

Perfect Forward Secrecy (PFS)

- Diffie-Hellman key group [194](#)

performance

- troubleshooting [524, 525](#)

PFS (Perfect Forward Secrecy) [194](#)

Phishing [322, 325](#)

pointer record [433](#)

policy routes [153](#)

- actions [155](#)
- and address objects [159](#)
- and ALG [183](#)
- and interfaces [159](#)
- and NAT [154](#)
- and schedules [159](#)
- and service objects [267](#)
- and trunks [146, 159](#)
- and user groups [158, 174, 177](#)
- and users [158, 174, 177](#)
- and VPN connections [529](#)

- benefits [154](#)
- criteria [155](#)
- overriding direct routes [156](#)
- troubleshooting [523](#)

pop-up windows [23](#)

port forwarding, see NAT

port groups [112](#)

port translation, see NAT

power off [519](#)

PPP

- troubleshooting [524](#)

PPP interfaces

- subnet mask [115](#)

PPPoE [117](#)

- and RADIUS [117](#)

PPPoE/PPTP interfaces [112](#)

PPTP

- as VPN [117](#)

product registration [551](#)

PTR record [433](#)

Public-Key Infrastructure (PKI) [454](#)

public-private key pairs [453](#)

Q

QoS [154](#)

Quick Start Guide [2](#)

R

rack-mounting [21, 56](#)

RADIUS [401, 403](#)

- advantages [403](#)
- and PPPoE [117](#)
- and users [390](#)

RADIUS server [448](#)

Reference Guide, CLI [2](#)

registration [105](#)

- product [551](#)

Relative Distinguished Name (RDN) [402](#)

Remote Authentication Dial-In User Service, see RADIUS

remote management

- see also service control [416](#)
 - to-Device security policy [236](#)
 - remote network [187](#)
 - reports
 - anti-virus [87, 89](#)
 - daily [479](#)
 - daily e-mail [479](#)
 - IDP [86](#)
 - reputation filter
 - anonymizers [322](#)
 - categories [322](#)
 - spyware adware keyloggers [322](#)
 - statistics [82](#)
 - reset [534](#)
 - RESET button [534](#)
 - Restart [535](#)
 - RFC
 - 1631 (NAT) [155](#)
 - 2131 (DHCP) [116](#)
 - 2132 (DHCP) [116](#)
 - 2402 (AH) [193](#)
 - 2406 (ESP) [193, 206](#)
 - round robin [144](#)
 - routing
 - troubleshooting [526](#)
 - routing protocols
 - and Ethernet interfaces [122, 128](#)
 - RSA [462, 466](#)
 - rubber feet [57](#)
- S**
- sandboxing
 - action [354](#)
 - defend center [352](#)
 - EICAR test files [353](#)
 - log [354](#)
 - security mechanism [352](#)
 - scan attacks [362](#)
 - scanner types [350](#)
 - Scanners [324](#)
 - schedule
 - troubleshooting [530](#)
 - schedules [277](#)
 - and content filtering [293, 294](#)
 - and current date/time [277](#)
 - and policy routes [159](#)
 - and security policy [241](#)
 - one-time [277](#)
 - recurring [277](#)
 - types of [277](#)
 - screen resolution [23](#)
 - Secure Hash Algorithm, see SHA1
 - Secure Socket Layer, see SSL
 - security associations, see IPSec
 - security policy [235](#)
 - actions [241](#)
 - and ALG [183](#)
 - and application patrol [283](#)
 - and IPSec VPN [529](#)
 - and logs [241](#)
 - and NAT [237](#)
 - and schedules [241](#)
 - and service groups [241](#)
 - and service objects [267](#)
 - and services [241](#)
 - and user groups [241, 253](#)
 - and users [241, 253](#)
 - and zones [235, 239](#)
 - asymmetrical routes [236, 238](#)
 - global rules [236](#)
 - priority [239](#)
 - rule criteria [236](#)
 - see also to-Device security policy [235](#)
 - session limits [249, 251](#)
 - triangle routes [236, 238](#)
 - troubleshooting [523](#)
- security settings
 - troubleshooting [523](#)
- sensitivity level [248](#)
- serial number [64](#)
- service control [416](#)
 - and to-ZyWALL security policy [416](#)
 - and users [416](#)
 - timeouts [416](#)
- service groups [267](#)
 - and security policy [241](#)
 - in IDP [363](#)
- service objects [266](#)
 - and IP protocols [267](#)
 - and policy routes [267](#)
 - and security policy [267](#)
- service subscription status [107](#)

- services **266**
 - and security policy **241**
- session limits **249, 251**
- sessions **78**
- SHA1 **190**
- shell scripts **483**
- shutdown **519**
- signature categories
 - access control **362**
 - backdoor/Trojan **362**
 - buffer overflow **361**
 - DoS/DDoS **362**
 - P2P **362**
 - scan **362**
 - virus/worm **362**
 - Web attack **361**
- signature ID **360**
- signatures
 - IDP **356**
 - updating **105, 228, 386, 388**
- Simple Network Management Protocol, see SNMP
- SIP
 - ALG **183**
- SNAT **155**
 - troubleshooting **526**
- SNMP **22, 443**
 - agents **443**
 - authentication **447**
 - Get **443**
 - GetNext **444**
 - Manager **443**
 - managers **443**
 - MIB **443, 444**
 - network components **443**
 - Set **444**
 - Trap **444**
 - traps **444**
 - version 3 and security **444**
 - versions **443**
- Source Network Address Translation, see SNAT
- Spam Sources **324**
- Spam URLs **322**
- spillover (for load balancing) **145**
- SQL Injection **325**
- SQL slammer **366**
- SSH **417, 418**
 - client requirements **418**
 - encryption methods **418**
 - versions **418**
- SSL **228, 417**
 - access policy **229**
 - connection monitor **103**
 - see also SSL VPN **228**
- SSL Inspection
 - Protocols **373**
- SSL inspection
 - Server Signed Certificate Keys **375**
- SSL policy
 - objects used **229**
- SSL VPN **228**
 - access policy **229**
 - full tunnel mode **228**
 - see also SSL **228**
- startup-config.conf **488, 490**
 - if errors **484**
 - missing at restart **483**
 - present at restart **484**
- startup-config-bad.conf **484**
- static routes **154**
 - and interfaces **162**
 - metric **162**
- statistics
 - anti-virus **87, 89**
 - daily e-mail report **479**
 - IDP **86**
- status **63**
- streaming protocols management **283**
- subscription services
 - status **107**
- supported browsers **23**
- syslog servers, see also logs
- system log, see logs
- system name **420**
- system-default.conf **488**

T

- TCP **266**
 - connections **266**
 - port numbers **267**
- throughput rate
 - troubleshooting **531**

- time [416](#)
 - to-Device security policy
 - and remote management [236](#)
 - global rules [235](#)
 - see also security policy [235](#)
 - Tor [325](#)
 - to-ZyWALL security policy
 - and NAT [170](#)
 - and NAT traversal (VPN) [529](#)
 - and service control [416](#)
 - and VPN [529](#)
 - trademarks [552](#)
 - Transmission Control Protocol, see TCP
 - transmission speed
 - cable types [48](#)
 - trapdoor attacks [362](#)
 - triangle routes [236](#)
 - allowing through the security policy [238](#)
 - vs virtual interfaces [236](#)
 - Triple Data Encryption Standard, see 3DES
 - trojan attacks [362](#)
 - troubleshooting [496](#), [522](#)
 - anti-virus [523](#), [524](#)
 - application patrol [523](#), [527](#), [529](#)
 - certificate [530](#)
 - connection resets [528](#)
 - content filter [523](#)
 - DDNS [527](#)
 - device access [522](#)
 - firmware upload [531](#)
 - FTP [527](#)
 - IDP [523](#), [525](#)
 - Internet access [522](#), [529](#)
 - IPSec VPN [528](#)
 - LEDs [522](#)
 - logs [531](#)
 - management access [531](#)
 - packet capture [531](#)
 - performance [524](#), [525](#)
 - policy routes [523](#)
 - PPP [524](#)
 - problems [522](#)
 - routing [526](#)
 - schedules [530](#)
 - security policy [523](#)
 - security settings [523](#)
 - SNAT [526](#)
 - throughput rate [531](#)
 - VLAN [524](#)
 - VPN [529](#)
 - trunks [112](#), [143](#)
 - and ALG [183](#)
 - and policy routes [146](#), [159](#)
 - member interface mode [149](#), [150](#)
 - see also load balancing [143](#)
 - Trusted Certificates, see also certificates [464](#)
 - tunnel encapsulation [206](#)
 - Tunnel interfaces [112](#)
- ## U
- UDP [266](#)
 - messages [266](#)
 - port numbers [267](#)
 - updating
 - anti-virus signatures [108](#), [109](#)
 - signatures [105](#), [228](#), [386](#), [388](#)
 - upgrading
 - firmware [493](#)
 - uploading
 - configuration files [487](#)
 - firmware [493](#)
 - URL Threat Filter [322](#), [334](#)
 - Priority [334](#)
 - user authentication [389](#)
 - external [390](#)
 - local user database [401](#)
 - User Datagram Protocol, see UDP
 - user group objects [389](#), [401](#)
 - user groups [389](#), [390](#), [401](#)
 - and content filtering [294](#)
 - and policy routes [158](#), [174](#), [177](#)
 - and security policy [241](#), [253](#)
 - user name
 - rules [392](#)
 - user objects [389](#), [401](#)
 - user sessions, see sessions
 - users [389](#), [401](#)
 - access, see also access users
 - admin (type) [389](#)
 - admin, see also admin users
 - and AAA servers [390](#)
 - and authentication method objects [390](#)

- and content filtering [294](#)
- and LDAP [390](#)
- and policy routes [158, 174, 177](#)
- and RADIUS [390](#)
- and security policy [241, 253](#)
- and service control [416](#)
- attributes for Ext-User [390](#)
- default lease time [399](#)
- default reauthentication time [399](#)
- default type for Ext-User [390](#)
- Ext-User (type) [390](#)
- ext-user (type) [389](#)
- groups, see user groups
- lease time [395](#)
- lockout [400](#)
- reauthentication time [395](#)
- types of [389](#)
- user (type) [389](#)
- user names [392](#)

V

- ventilation holes [56](#)
- virtual interfaces [112](#)
 - not DHCP clients [115](#)
 - vs asymmetrical routes [236](#)
 - vs triangle routes [236](#)
- Virtual Private Network, see VPN
- virus [362](#)
 - attack [342, 362](#)
 - boot sector [342](#)
 - e-mail [342](#)
 - file infector [342](#)
 - macro [342](#)
 - mutation [342](#)
 - polymorphic [342](#)
- VLAN
 - advantages [118](#)
 - and MAC address [118](#)
 - ID [118](#)
 - troubleshooting [524](#)
- VLAN interfaces [112, 118](#)
 - and Ethernet interfaces [118, 524](#)
- VoIP pass through
 - see also ALG [183](#)
- VPN [187](#)
 - active protocol [193](#)

- and NAT [192](#)
- basic troubleshooting [528](#)
- IKE SA, see IKE SA
- IPSec [187](#)
- IPSec SA
 - proposal [189](#)
- security associations (SA) [195](#)
- see also IKE SA
- see also IPSec [187](#)
- see also IPSec SA
- troubleshooting [529](#)
- VPN connections
 - and policy routes [529](#)
- VPN gateways
 - and to-ZyWALL security policy [529](#)

W

- wall-mounting [58](#)
- warranty [551, 555](#)
 - note [551, 555](#)
- Web attack [361](#)
- Web Configurator [21](#)
 - access [23](#)
 - requirements [23](#)
 - supported browsers [23](#)
- weighted round robin (for load balancing) [144](#)
- Windows Internet Naming Service, see WINS.
- WINS [117](#)
- Wizard Setup [36](#)
- WLAN interfaces [112](#)
- worm [342, 362](#)
 - attacks [362](#)

Z

- zones [273](#)
 - and interfaces [273](#)
 - and security policy [235, 239](#)
 - and VPN [273](#)
 - extra-zone traffic [274](#)
 - inter-zone traffic [274](#)
 - intra-zone traffic [274](#)
 - types of traffic [274](#)